

N-Channel Dual Gate MOS-Fieldeffect Tetrode, Depletion Mode

Electrostatic sensitive device.
Observe precautions for handling.



Applications

Input- and mixerstages especially for FM- and VHF TV-tuners up to 300 MHz.

Features

- Integrated gate protection diodes
- High cross modulation performance
- Low noise figure
- High AGC-range
- Low feedback capacitance
- Low input capacitance

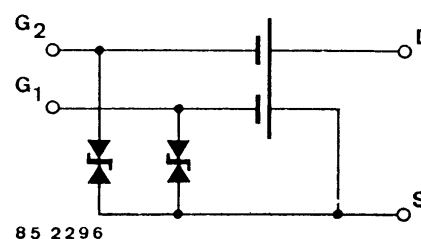
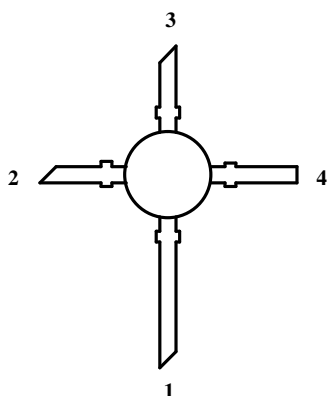

BF961 Marking: BF961

Plastic case (TO 50)

1 = Drain, 2 = Source, 3 = Gate 1, 4 = Gate 2

Absolute Maximum Ratings

Parameters	Symbol	Value	Unit
Drain source voltage	V_{DS}	20	V
Drain current	I_D	30	mA
Gate 1/gate 2-source peak current	$\pm I_{G1/2SM}$	10	mA
Total power dissipation $T_{amb} \leq 60^\circ C$	P_{tot}	200	mW
Channel temperature	T_{Ch}	150	$^\circ C$
Storage temperature range	T_{stg}	-55 to +150	$^\circ C$

Maximum Thermal Resistance

Parameters	Symbol	Value	Unit
Channel ambient on glass fibre printed board (40 x 25 x 1.5) mm ³ plated with 35 μm Cu	R_{thChA}	450	K/W

Electrical DC Characteristics

$T_{amb} = 25^{\circ}\text{C}$, unless otherwise specified

Parameters / Test Conditions	Type	Symbol	Min.	Typ.	Max.	Unit
Drain-source breakdown voltage $I_D = 10 \mu\text{A}$, $-V_{G1S} = -V_{G2S} = 4 \text{ V}$		$V_{(BR)DS}$	20			V
Gate 1-source breakdown voltage $\pm I_{G1S} = 10 \text{ mA}$, $V_{G2S} = V_{DS} = 0$		$\pm V_{(BR)G1SS}$	8		14	V
Gate 2-source breakdown voltage $\pm I_{G2S} = 10 \text{ mA}$, $V_{G1S} = V_{DS} = 0$		$\pm V_{(BR)G2SS}$	8		14	V
Gate 1-source leakage current $\pm V_{G1S} = 5 \text{ V}$, $V_{G2S} = V_{DS} = 0$		$\pm I_{G1SS}$			100	nA
Gate 2-source leakage current $\pm V_{G2S} = 5 \text{ V}$, $V_{G1S} = V_{DS} = 0$		$\pm I_{G2SS}$			100	nA
Drain current $V_{DS} = 15 \text{ V}$, $V_{G1S} = 0$, $V_{G2S} = 4 \text{ V}$	BF961 BF961A BF961B	I_{DSS} I_{DSS} I_{DSS}	4 4 9.5		20 10.5 20	mA mA mA
Gate 1-source cut-off voltage $V_{DS} = 15 \text{ V}$, $V_{G2S} = 4 \text{ V}$, $I_D = 20 \mu\text{A}$		$-V_{G1S(OFF)}$			3.5	V
Gate 2-source cut-off voltage $V_{DS} = 15 \text{ V}$, $V_{G1S} = 0$, $I_D = 20 \mu\text{A}$		$-V_{G2S(OFF)}$			3.5	V

Electrical AC Characteristics

$V_{DS} = 15 \text{ V}$, $I_D = 10 \text{ mA}$, $V_{G2S} = 4 \text{ V}$, $f = 1 \text{ MHz}$, $T_{amb} = 25^{\circ}\text{C}$, unless otherwise specified

Parameters / Test Conditions	Type	Symbol	Min.	Typ.	Max.	Unit
Forward transadmittance		$ y_{21s} $	12	15		mS
Gate 1-input capacitance		C_{issg1}		3.7		pF
Gate 2-input capacitance $V_{G1S} = 0$, $V_{G2S} = 4 \text{ V}$		C_{issg2}		1.6		pF
Feedback capacitance		C_{rss}		25		fF
Output capacitance		C_{oss}		1.6		pF
Power gain $V_{DS} = 15 \text{ V}$, $V_{G1S} = 0$, $V_{G2S} = 4 \text{ V}$ $g_s = 2 \text{ mS}$, $g_L = 0,5 \text{ mS}$, $f = 200 \text{ MHz}$		G_{ps}		20		dB
AGC range $V_{DS} = 15 \text{ V}$, $V_{G2S} = 4 \dots -2 \text{ V}$ $f = 200 \text{ MHz}$	AGC range	ΔG_{ps}		50		dB
Noise figure $V_{DS} = 15 \text{ V}$, $V_{G1S} = 0$, $V_{G2S} = 4 \text{ V}$ $g_s = 2 \text{ mS}$, $f = 200 \text{ MHz}$		F		1.8	2.5	dB

Typical Characteristics ($T_j = 25^\circ\text{C}$ unless otherwise specified)

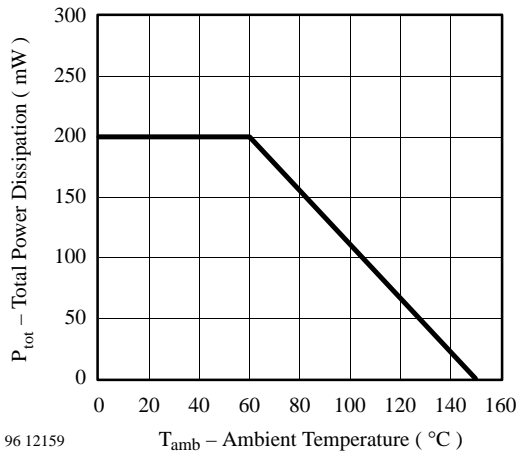

Figure 1. Total Power Dissipation vs. Ambient Temperature

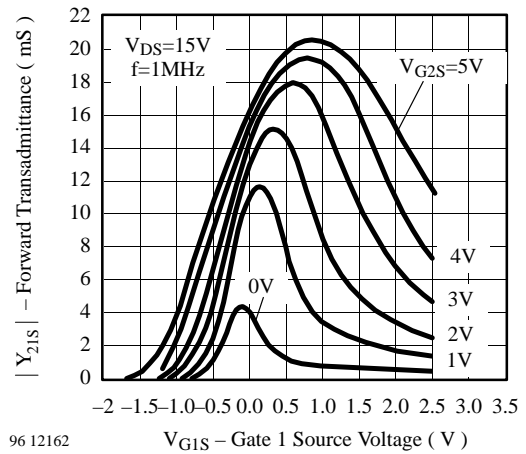

Figure 4. Forward Transadmittance vs. Gate 1 Source Voltage

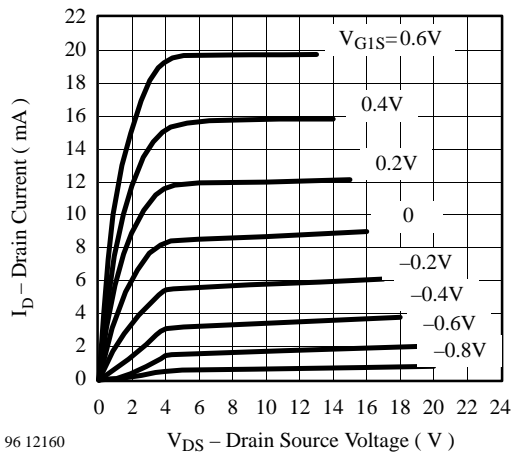

Figure 2. Drain Current vs. Drain Source Voltage

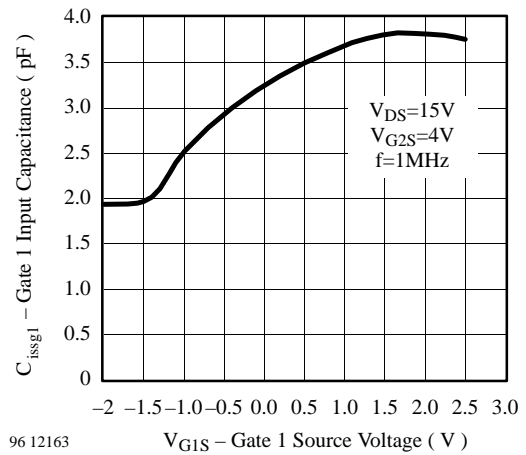

Figure 5. Gate 1 Input Capacitance vs. Gate 1 Source Voltage

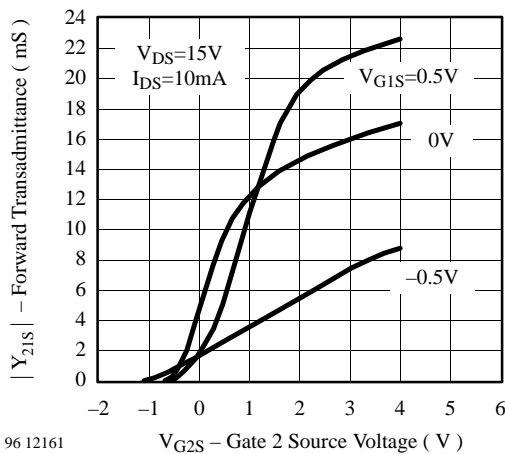

Figure 3. Forward Transadmittance vs. Gate 2 Source Voltage

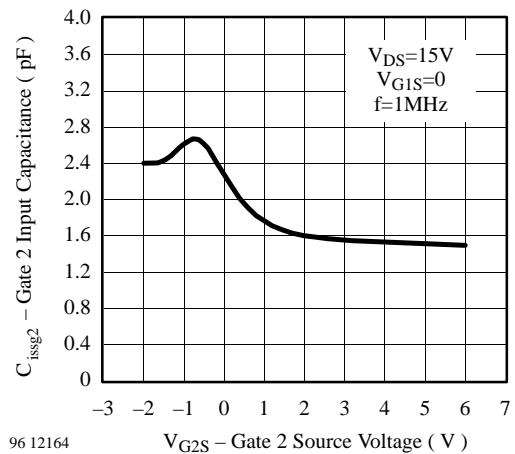

Figure 6. Gate 2 Input Capacitance vs. Gate 2 Source Voltage

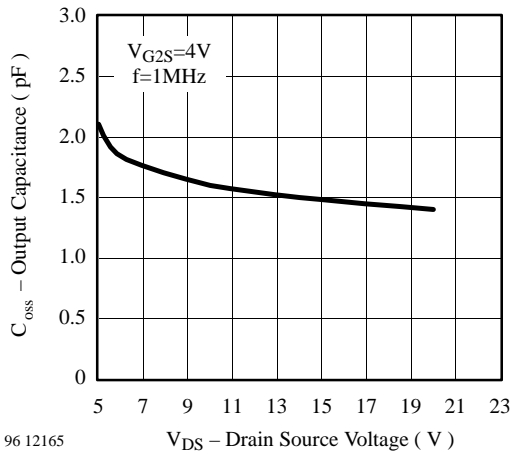

Figure 7. Output Capacitance vs. Drain Source Voltage

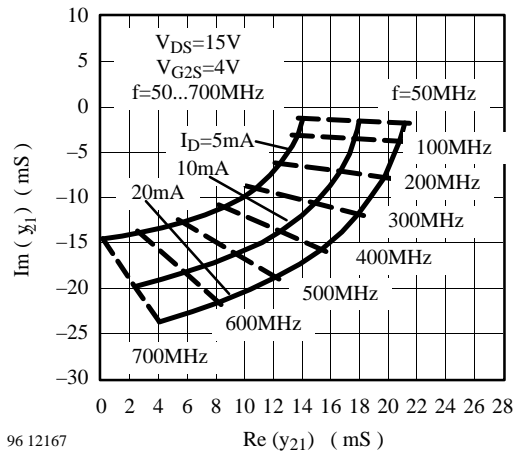

Figure 9. Short Circuit Forward Transfer Admittance

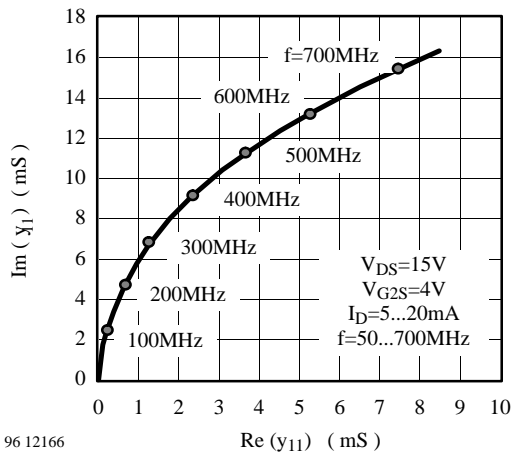

Figure 8. Short Circuit Input Admittance

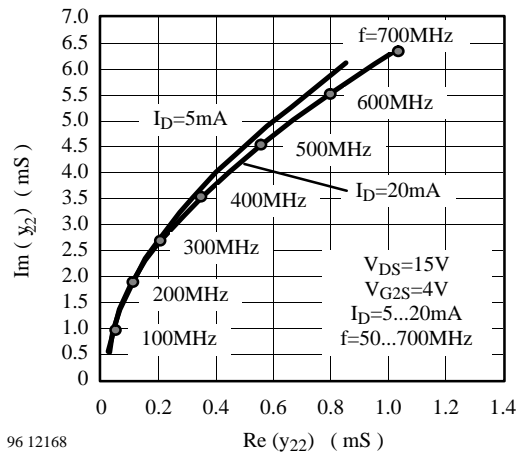
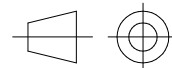
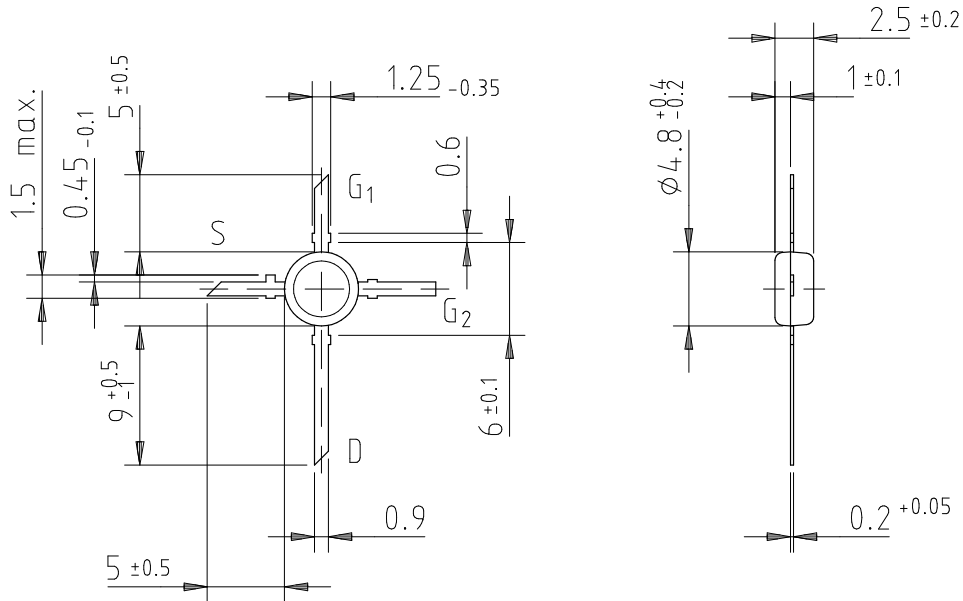

Figure 10. Short Circuit Output Admittance

Dimensions in mm



96 12242

technical drawings
according to DIN
specifications

Ozone Depleting Substances Policy Statement

It is the policy of **TEMIC TELEFUNKEN microelectronic GmbH** to

1. Meet all present and future national and international statutory requirements.
2. Regularly and continuously improve the performance of our products, processes, distribution and operating systems with respect to their impact on the health and safety of our employees and the public, as well as their impact on the environment.

It is particular concern to control or eliminate releases of those substances into the atmosphere which are known as ozone depleting substances (ODSs).

The Montreal Protocol (1987) and its London Amendments (1990) intend to severely restrict the use of ODSs and forbid their use within the next ten years. Various national and international initiatives are pressing for an earlier ban on these substances.

TEMIC TELEFUNKEN microelectronic GmbH semiconductor division has been able to use its policy of continuous improvements to eliminate the use of ODSs listed in the following documents.

1. Annex A, B and list of transitional substances of the Montreal Protocol and the London Amendments respectively
2. Class I and II ozone depleting substances in the Clean Air Act Amendments of 1990 by the Environmental Protection Agency (EPA) in the USA
3. Council Decision 88/540/EEC and 91/690/EEC Annex A, B and C (transitional substances) respectively.

TEMIC can certify that our semiconductors are not manufactured with ozone depleting substances and do not contain such substances.

We reserve the right to make changes to improve technical design and may do so without further notice.

Parameters can vary in different applications. All operating parameters must be validated for each customer application by the customer. Should the buyer use TEMIC products for any unintended or unauthorized application, the buyer shall indemnify TEMIC against all claims, costs, damages, and expenses, arising out of, directly or indirectly, any claim of personal damage, injury or death associated with such unintended or unauthorized use.

TEMIC TELEFUNKEN microelectronic GmbH, P.O.B. 3535, D-74025 Heilbronn, Germany
Telephone: 49 (0)7131 67 2831, Fax number: 49 (0)7131 67 2423