

COMPLEMENTARY SILICON POWER DARLINGTON TRANSISTORS

- BDX53B, BDX53C, BDX54B AND BDX54C ARE SGS-THOMSON PREFERRED SALESTYPES

APPLICATIONS

- AUDIO AMPLIFIERS
- LINEAR AND SWITCHING INDUSTRIAL EQUIPMENT

DESCRIPTION

The BDX53A, BDX53B and BDX53C are silicon epitaxial-base NPN power transistors in monolithic Darlington configuration and are mounted in Jedec TO-220 plastic package. They are intended for use in hammer drivers, audio amplifiers and other medium power linear and switching applications.

The complementary PNP types for BDX53B and BDX53C are the BDX54B and BDX54C respectively.

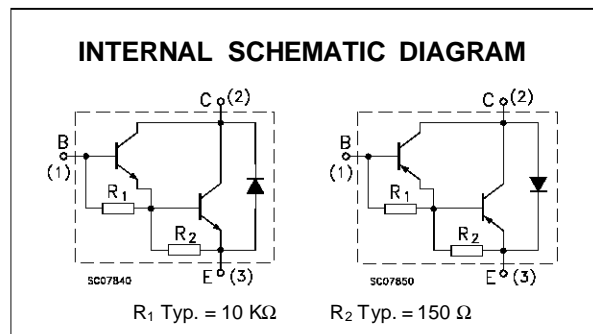
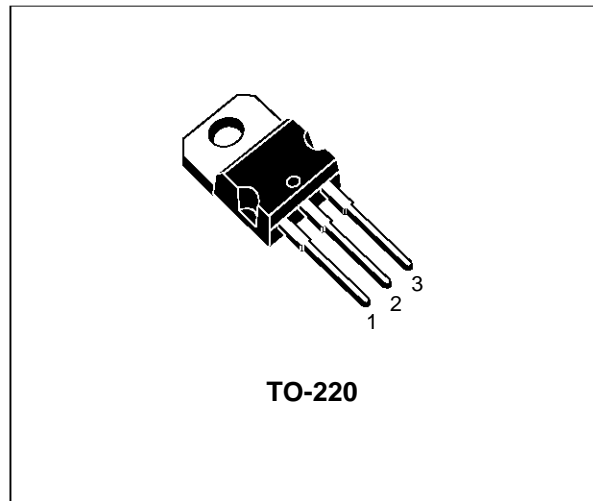

ABSOLUTE MAXIMUM RATINGS

Symbol	Parameter	Value			Unit	
		NPN	BDX53A	BDX53B		BDX53C
		PNP		BDX54B		BDX54C
V_{CBO}	Collector-Base Voltage ($I_E = 0$)		60	80	100	V
V_{CEO}	Collector-Emitter Voltage ($I_B = 0$)		60	80	100	V
V_{EBO}	Emitter-base Voltage ($I_C = 0$)			5		V
I_C	Collector Current			8		A
I_{CM}	Collector Peak Current (repetitive)			12		A
I_B	Base Current			0.2		A
P_{tot}	Total Dissipation at $T_c \leq 25^\circ\text{C}$			60		W
T_{stg}	Storage Temperature			-65 to 150		$^\circ\text{C}$
T_j	Max. Operating Junction Temperature			150		$^\circ\text{C}$

BDX53A/53B/53C-BDX54B/54C

THERMAL DATA

R _{thj-case}	Thermal Resistance Junction-case	Max	2.08	°C/W
R _{thj-amb}	Thermal Resistance Junction-ambient	Max	70	°C/W

ELECTRICAL CHARACTERISTICS (T_{case} = 25 °C unless otherwise specified)

Symbol	Parameter	Test Conditions	Min.	Typ.	Max.	Unit	
I _{CBO}	Collector Cut-off Current (I _E = 0)	for BDX53A V _{CB} = 60 V for BDX53B/54B V _{CB} = 80 V for BDX53C/54C V _{CB} = 100V			0.2 0.2 0.2	mA mA mA	
I _{CEO}	Collector Cut-off Current (I _B = 0)	for BDX53A V _{CB} = 30 V for BDX53B/54B V _{CB} = 40 V for BDX53C/54C V _{CB} = 50V			0.5 0.5 0.5	mA mA mA	
I _{EBO}	Emitter Cut-off Current (I _C = 0)	V _{EB} = 5 V			2	mA	
V _{CEO(sus)*}	Collector-Emitter Sustaining Voltage (I _B = 0)	I _C = 100 mA	for BDX53A 60 for BDX53B/54B 80 for BDX53C/54C 100			V V V	
V _{CE(sat)*}	Collector-emitter Saturation Voltage	I _C = 3 A	I _B = 12 mA			2	V
V _{BE(sat)*}	Base-emitter Saturation Voltage	I _C = 3 A	I _B = 12 mA			2.5	V
h _{FE*}	DC Current Gain	I _C = 3 A	V _{CE} = 3 V	750			
V _{F*}	Parallel-diode Forward Voltage	I _F = 3 A I _F = 8 A			1.8 2.5	V V	

* Pulsed: Pulse duration = 300 μs, duty cycle 1.5 %
For PNP types voltage and current values are negative.

Safe Operating Area

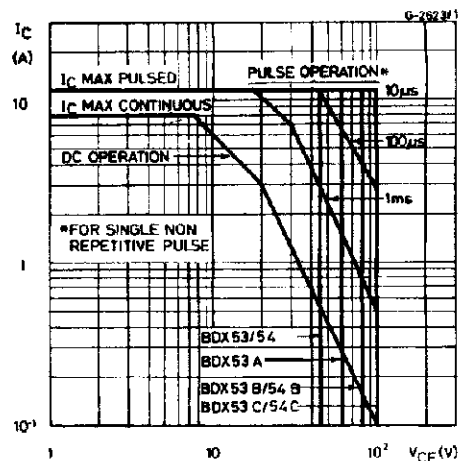

Derating Curve

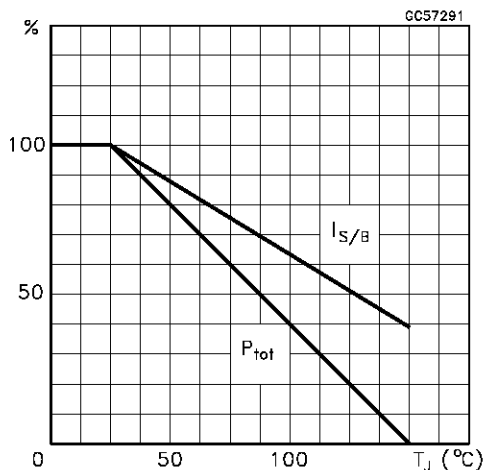

DC Current Gain (NPN type)

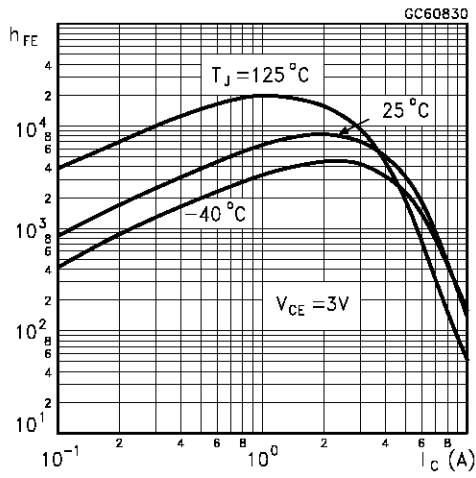

DC Current Gain (PNP type)

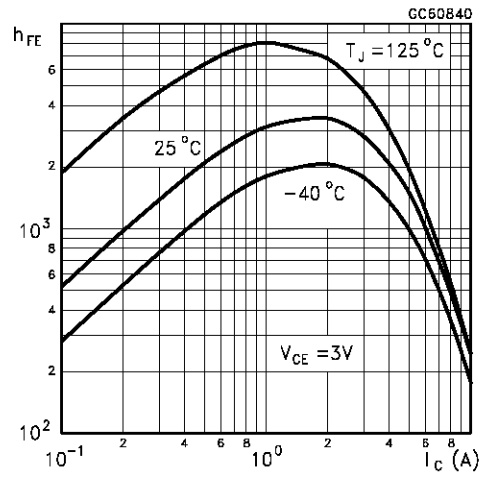

Collector Emitter Saturation Voltage (NPN type)

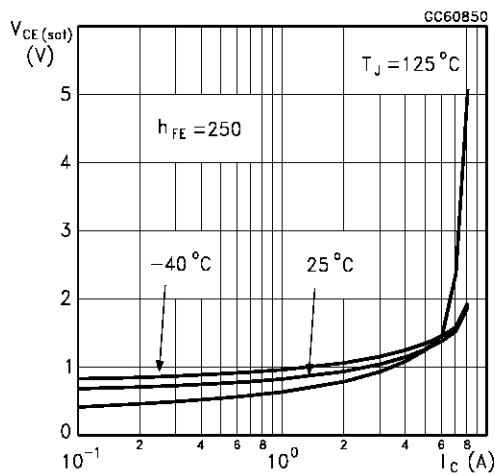

Collector Emitter Saturation Voltage (PNP type)

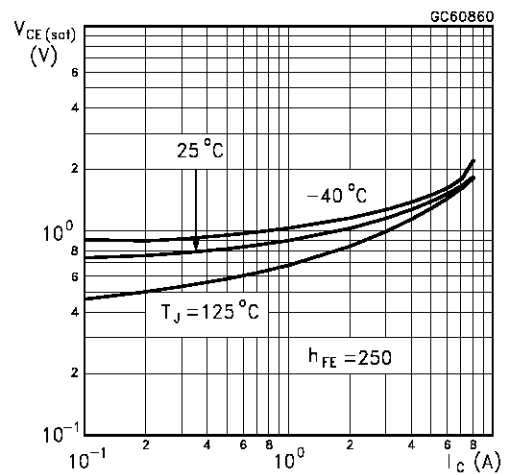

Base Emitter Saturation Voltage (NPN type)

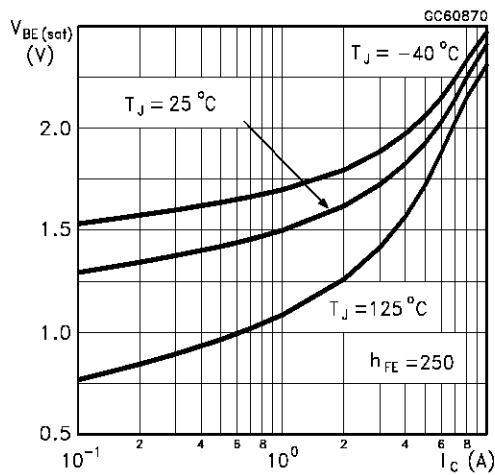

Base Emitter Saturation Voltage (PNP type)

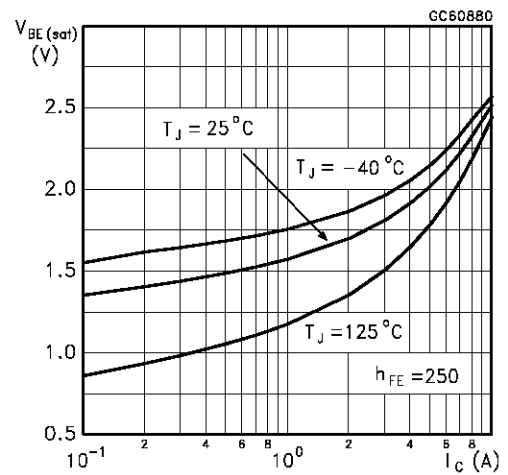

BDX53A/53B/53C-BDX54B/54C

Base Emitter On Voltage (NPN type)

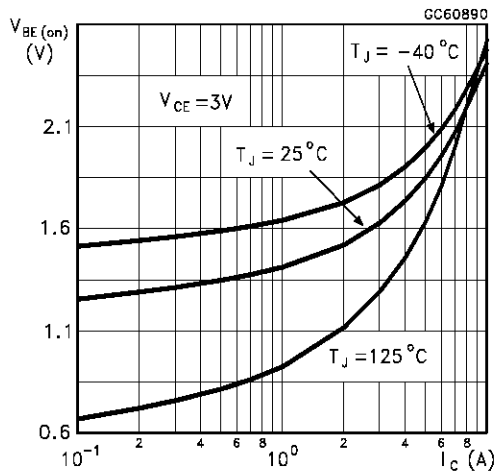

Base Emitter On Voltage (PNP type)

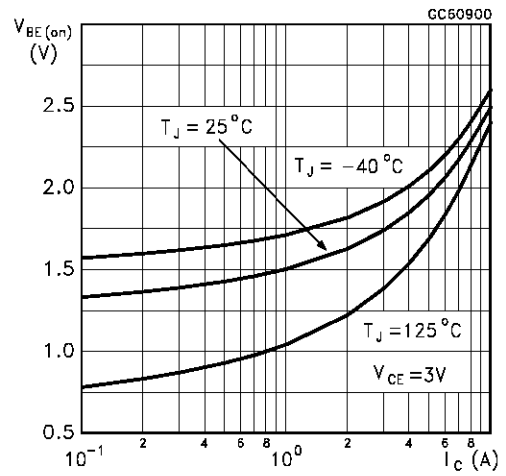

Freewheel Diode Forward Voltage (NPN type)

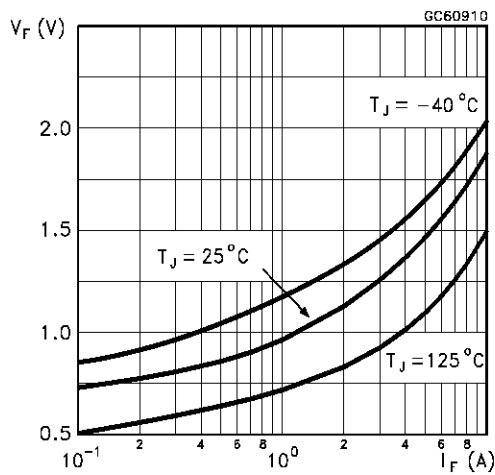

Freewheel Diode Forward Voltage (PNP type)

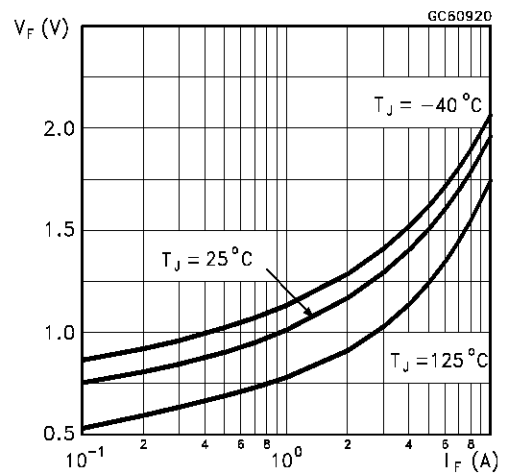

Switching Time Resistive Load (NPN type)

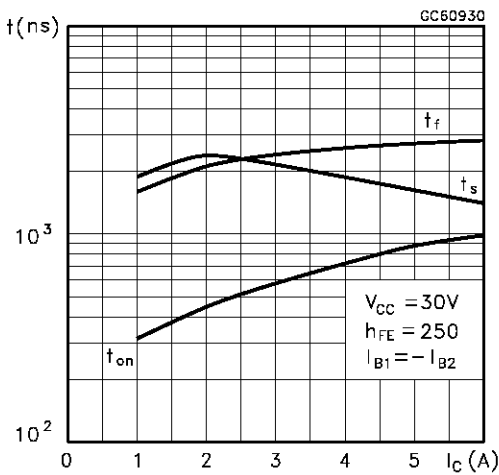

Switching Time resistive Load (PNP type)

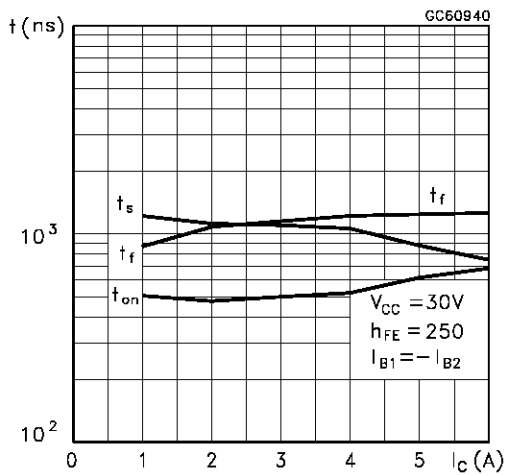

TO-252 (DPAK) MECHANICAL DATA

DIM.	mm			inch		
	MIN.	TYP.	MAX.	MIN.	TYP.	MAX.
A	2.2		2.4	0.086		0.094
A1	0.9		1.1	0.035		0.043
A2	0.03		0.23	0.001		0.009
B	0.64		0.9	0.025		0.035
B2	5.2		5.4	0.204		0.212
C	0.45		0.6	0.017		0.023
C2	0.48		0.6	0.019		0.023
D	6		6.2	0.236		0.244
E	6.4		6.6	0.252		0.260
G	4.4		4.6	0.173		0.181
H	9.35		10.1	0.368		0.397
L2		0.8			0.031	
L4	0.6		1	0.023		0.039

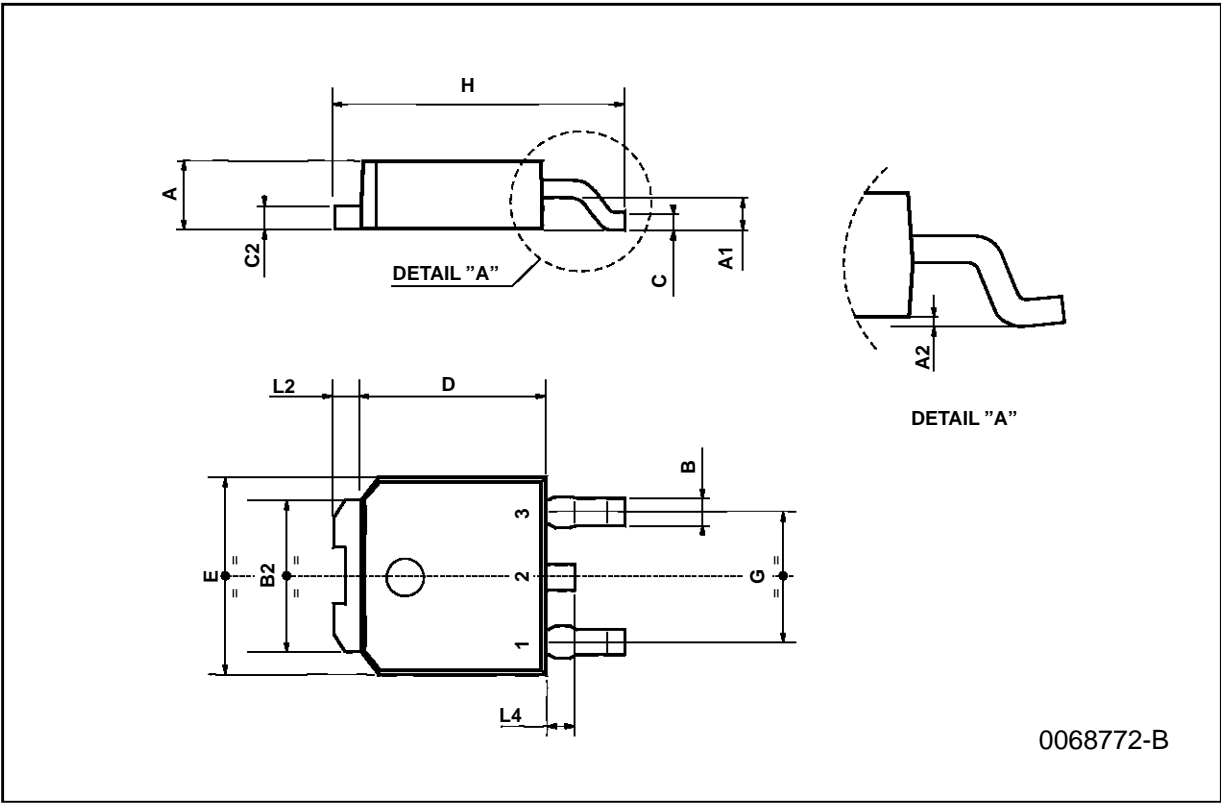

Information furnished is believed to be accurate and reliable. However, SGS-THOMSON Microelectronics assumes no responsibility for the consequences of use of such information nor for any infringement of patents or other rights of third parties which may result from its use. No license is granted by implication or otherwise under any patent or patent rights of SGS-THOMSON Microelectronics. Specifications mentioned in this publication are subject to change without notice. This publication supersedes and replaces all information previously supplied. SGS-THOMSON Microelectronics products are not authorized for use as critical components in life support devices or systems without express written approval of SGS-THOMSON Microelectronics.

© 1997 SGS-THOMSON Microelectronics - Printed in Italy - All Rights Reserved

SGS-THOMSON Microelectronics GROUP OF COMPANIES
Australia - Brazil - Canada - China - France - Germany - Hong Kong - Italy - Japan - Korea - Malaysia - Malta - Morocco - The Netherlands -
Singapore - Spain - Sweden - Switzerland - Taiwan - Thailand - United Kingdom - U.S.A

...