

COMPLEMENTARY SILICON POWER TRANSISTORS

- SGS-THOMSON PREFERRED SALESTYPES
- COMPLEMENTARY PNP - NPN DEVICES

APPLICATION

- LINEAR AND SWITCHING INDUSTRIAL EQUIPMENT

DESCRIPTION

The BD707, BD709, and BD711 are silicon epitaxial-base NPN power transistors in Jedec TO-220 plastic package, intended for use in power linear and switching applications.

The complementary PNP types are BD708, BD710, and BD712 respectively.

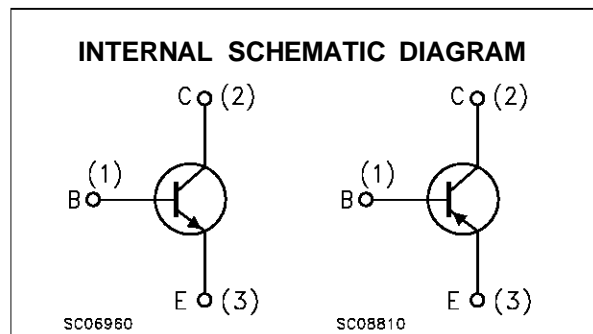
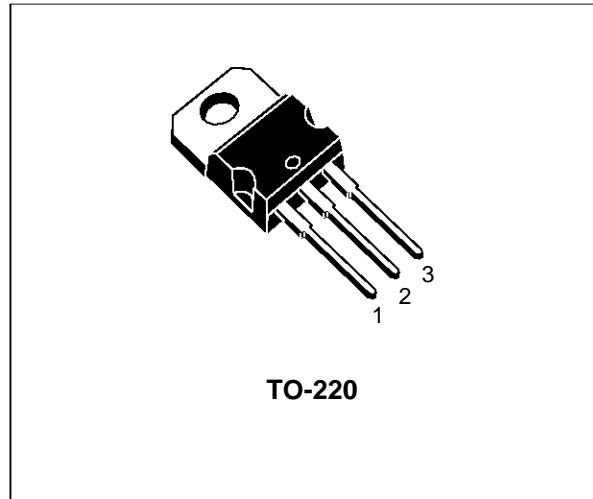

ABSOLUTE MAXIMUM RATINGS

Symbol	Parameter	Value			Unit	
		NPN	BD707	BD709		BD711
		PNP	BD708	BD710		BD712
V_{CBO}	Collector-Base Voltage ($I_E = 0$)		60	80	100	V
V_{CER}	Collector-Emitter Voltage ($V_{BE} = 0$)		60	80	100	V
V_{CEO}	Collector-Emitter Voltage ($I_B = 0$)		60	80	100	V
V_{EBO}	Emitter-Base Voltage ($I_C = 0$)		5			V
I_C	Collector Current		12			A
I_B	Base Current		5			A
P_{tot}	Total Dissipation at $T_c \leq 25^\circ\text{C}$		75			W
T_{stg}	Storage Temperature		-65 to 150			$^\circ\text{C}$
T_j	Max. Operating Junction Temperature		150			$^\circ\text{C}$

For PNP types voltage and current values are negative

BD707/708/709/710/711/712

THERMAL DATA

R _{thj-case}	Thermal Resistance Junction-case	Max	1.67	°C/W
R _{thj-amb}	Thermal Resistance Junction-ambient	Max	70	°C/W

ELECTRICAL CHARACTERISTICS (T_{case} = 25 °C unless otherwise specified)

Symbol	Parameter	Test Conditions	Min.	Typ.	Max.	Unit	
I _{CBO}	Collector Cut-off Current (I _E = 0)	for BD707/708 V _{CB} = 60 V			100	μA	
		for BD709/710 V _{CB} = 80 V			100	μA	
		for BD711/712 V _{CB} = 100 V			100	μA	
		T _{case} = 150 °C					
		for BD707/708 V _{CB} = 60 V			1	mA	
		for BD709/710 V _{CB} = 80 V			1	mA	
for BD711/712 V _{CB} = 100 V			1	mA			
I _{CEO}	Collector Cut-off Current (I _B = 0)	for BD707/708 V _{CE} = 30 V			100	mA	
		for BD709/710 V _{CE} = 40 V			100	mA	
		for BD711/712 V _{CE} = 50 V			100	mA	
I _{EBO}	Emitter Cut-off Current (I _C = 0)	V _{EB} = 5 V			1	mA	
V _{CEO(sus)*}	Collector-Emitter Sustaining Voltage (I _B = 0)	I _C = 100 mA	for BD707/708 60			V	
			for BD709/710 80			V	
			for BD711/712 100			V	
V _{CE(sat)*}	Collector-Emitter Saturation Voltage	I _C = 4 A I _B = 0.4 A			1	V	
V _{CEK*}	Knee Voltage	I _C = 3 A I _B = **			0.4	V	
V _{BE*}	Base-Emitter Voltage	I _C = 4 A V _{CE} = 4 V			1.5	V	
h _{FE*}	DC Current Gain	I _C = 0.5 A V _{CE} = 2 V	40	120	400		
		I _C = 2 A V _{CE} = 2 V	30				
		for BD707/708	30				
		for BD709/710	30				
		I _C = 4 A V _{CE} = 4 V	15		150		
		for BD707/708	15		150		
for BD709/710	15		150				
for BD711/712	15		150				
I _C = 10 A V _{CE} = 4 V	5	10					
for BD707/708		8					
for BD709/710		8					
for BD711/712		8					
f _T	Transition frequency	I _C = 300 mA V _{CE} = 3 V	3			MHz	

* Pulsed: Pulse duration = 300 μs, duty cycle 1.5 %

** Value for which I_C = 3.3 A at V_{CE} = 2V.

For PNP types voltage and current values are negative.

Safe Operating Areas

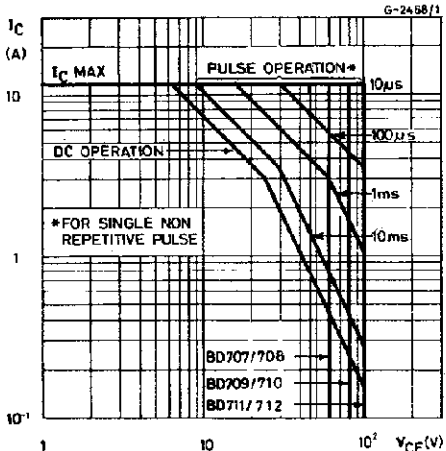

Derating Curve

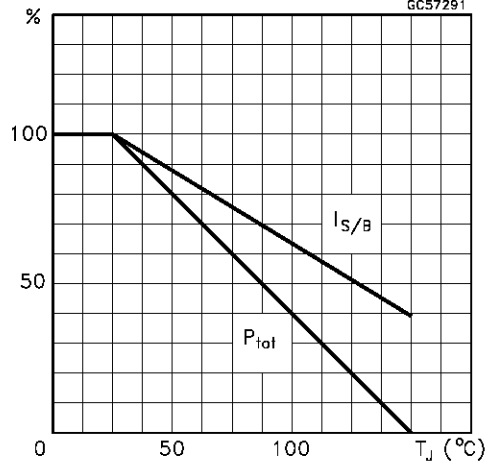

DC Current Gain(NPN type)

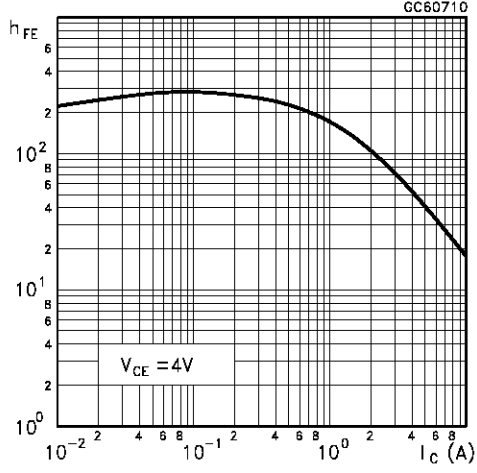

DC Current Gain(PNP type)

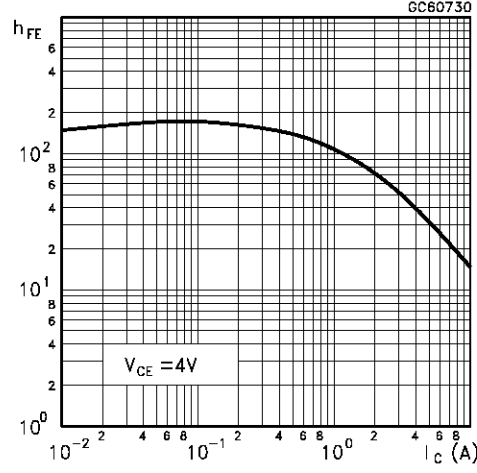

DC Transconductance(NPN type)

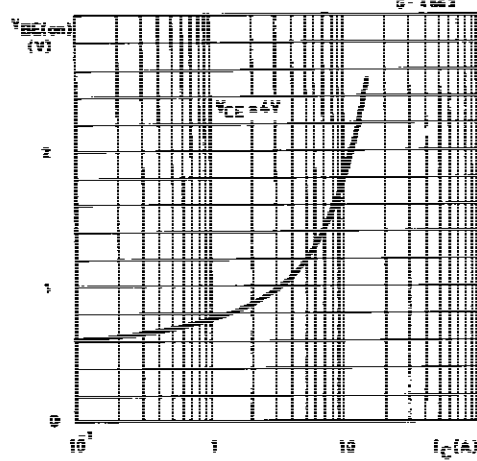

DC Transconductance(PNP type)

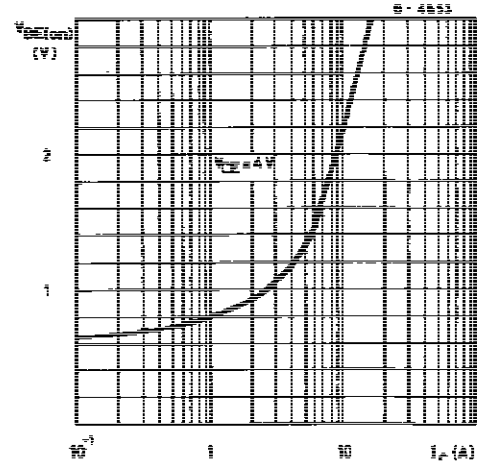

Collector-Emitter Saturation Voltage (NPN type)

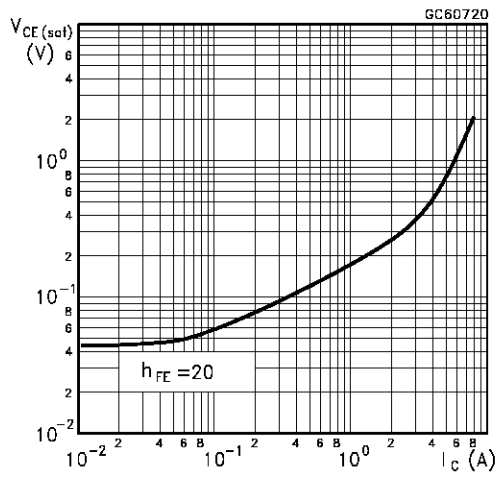

Collector-Emitter Saturation Voltage (PNP type)

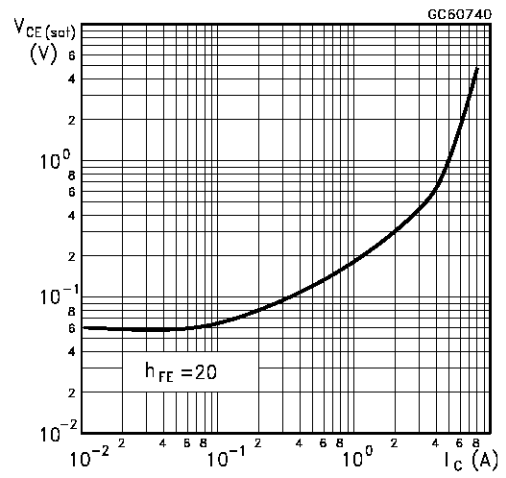

Base-Emitter Saturation Voltage (NPN type)

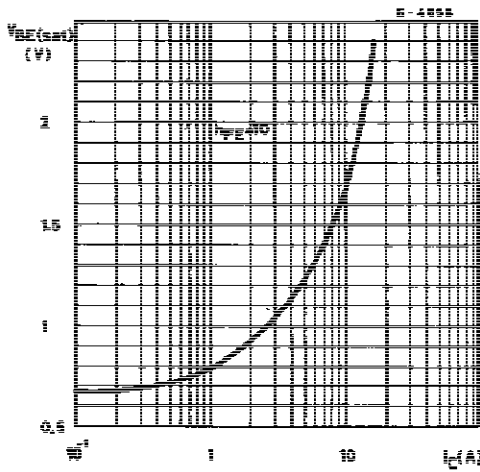

Base-Emitter Saturation Voltage (PNP type)

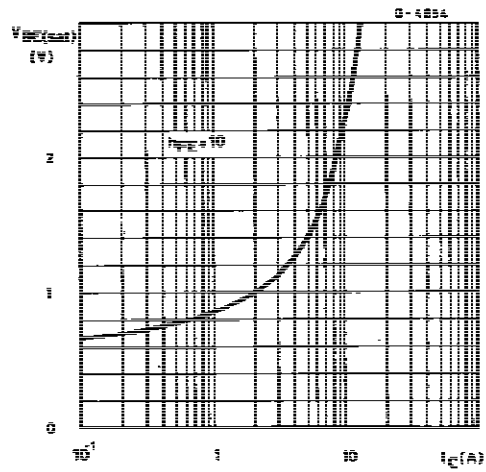

Transition Frequency (NPN type)

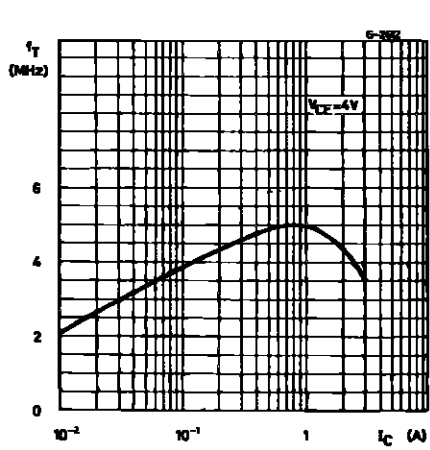

Transition Frequency (PNP type)

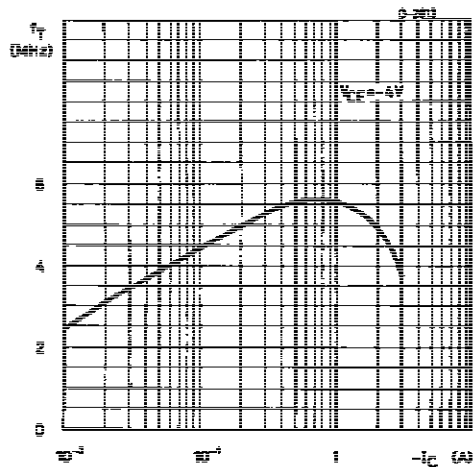

TO-220 MECHANICAL DATA

DIM.	mm			inch		
	MIN.	TYP.	MAX.	MIN.	TYP.	MAX.
A	4.40		4.60	0.173		0.181
C	1.23		1.32	0.048		0.051
D	2.40		2.72	0.094		0.107
D1		1.27			0.050	
E	0.49		0.70	0.019		0.027
F	0.61		0.88	0.024		0.034
F1	1.14		1.70	0.044		0.067
F2	1.14		1.70	0.044		0.067
G	4.95		5.15	0.194		0.203
G1	2.4		2.7	0.094		0.106
H2	10.0		10.40	0.393		0.409
L2		16.4			0.645	
L4	13.0		14.0	0.511		0.551
L5	2.65		2.95	0.104		0.116
L6	15.25		15.75	0.600		0.620
L7	6.2		6.6	0.244		0.260
L9	3.5		3.93	0.137		0.154
DIA.	3.75		3.85	0.147		0.151

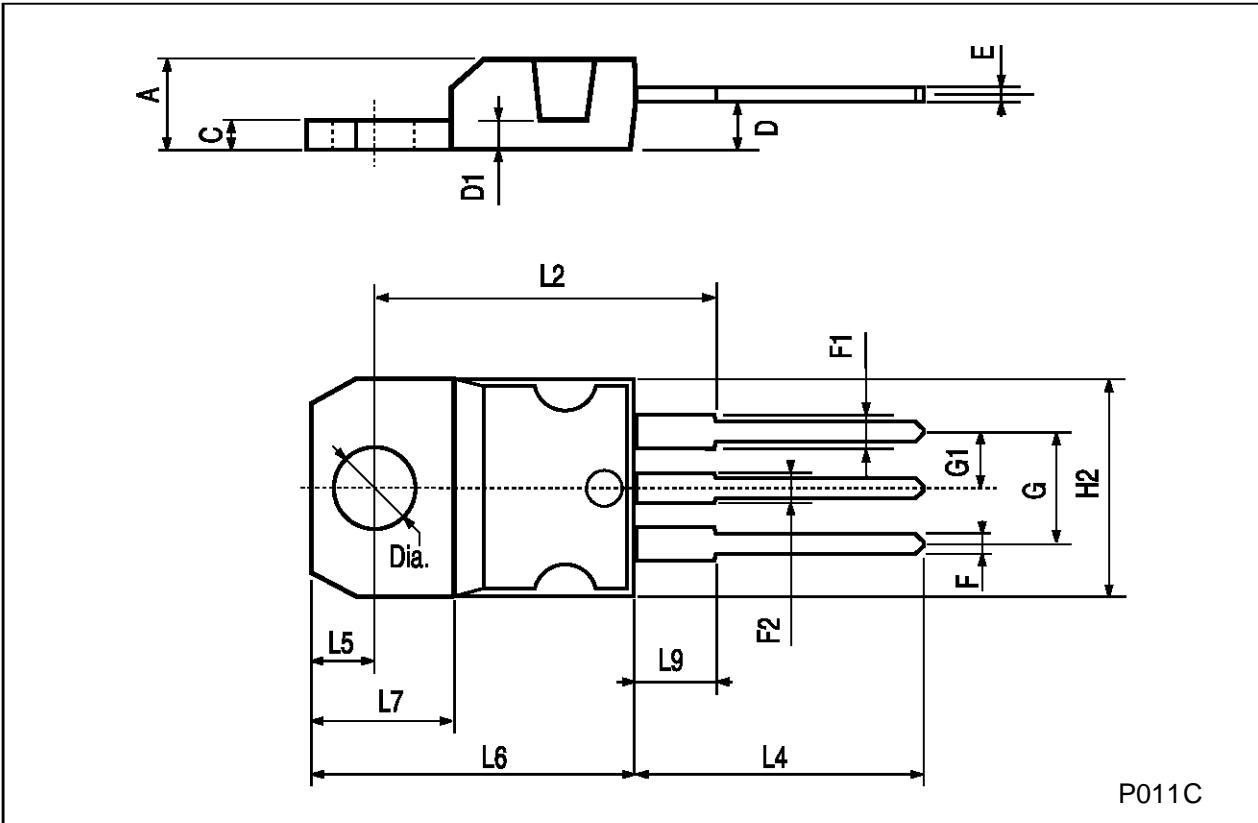

Information furnished is believed to be accurate and reliable. However, SGS-THOMSON Microelectronics assumes no responsibility for the consequences of use of such information nor for any infringement of patents or other rights of third parties which may result from its use. No license is granted by implication or otherwise under any patent or patent rights of SGS-THOMSON Microelectronics. Specifications mentioned in this publication are subject to change without notice. This publication supersedes and replaces all information previously supplied. SGS-THOMSON Microelectronics products are not authorized for use as critical components in life support devices or systems without express written approval of SGS-THOMSON Microelectronics.

© 1997 SGS-THOMSON Microelectronics - Printed in Italy - All Rights Reserved

SGS-THOMSON Microelectronics GROUP OF COMPANIES
Australia - Brazil - Canada - China - France - Germany - Hong Kong - Italy - Japan - Korea - Malaysia - Malta - Morocco - The Netherlands -
Singapore - Spain - Sweden - Switzerland - Taiwan - Thailand - United Kingdom - U.S.A
...