

## COMPLEMENTARY SILICON POWER TRANSISTORS

- SGS-THOMSON PREFERRED SALESTYPES
- COMPLEMENTARY PNP - NPN DEVICES

### APPLICATION

- LINEAR AND SWITCHING INDUSTRIAL EQUIPMENT

### DESCRIPTION

The BD707, BD709, and BD711 are silicon epitaxial-base NPN power transistors in Jedec TO-220 plastic package, intended for use in power linear and switching applications.

The complementary PNP types are BD708, BD710, and BD712 respectively.

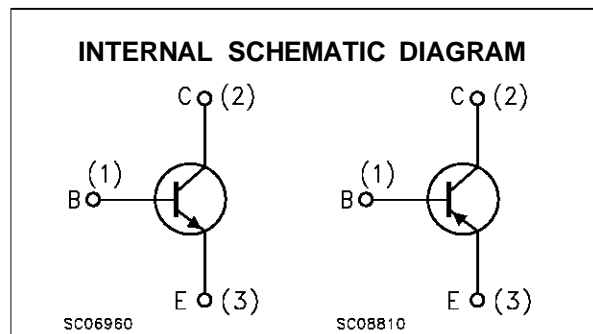
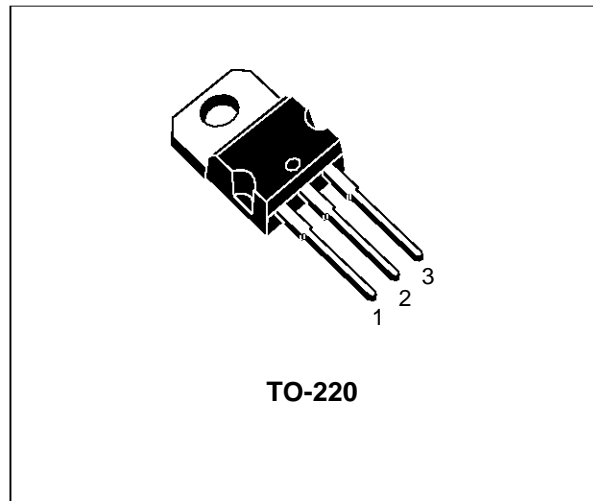

### ABSOLUTE MAXIMUM RATINGS

Symbol	Parameter	Value			Unit	
		NPN	BD707	BD709		BD711
		PNP	BD708	BD710		BD712
$V_{CBO}$	Collector-Base Voltage ( $I_E = 0$ )		60	80	100	V
$V_{CER}$	Collector-Emitter Voltage ( $V_{BE} = 0$ )		60	80	100	V
$V_{CEO}$	Collector-Emitter Voltage ( $I_B = 0$ )		60	80	100	V
$V_{EBO}$	Emitter-Base Voltage ( $I_C = 0$ )		5			V
$I_C$	Collector Current		12			A
$I_B$	Base Current		5			A
$P_{tot}$	Total Dissipation at $T_c \leq 25^\circ\text{C}$		75			W
$T_{stg}$	Storage Temperature		-65 to 150			$^\circ\text{C}$
$T_j$	Max. Operating Junction Temperature		150			$^\circ\text{C}$

For PNP types voltage and current values are negative

# BD707/708/709/710/711/712

## THERMAL DATA

R <sub>thj-case</sub>	Thermal Resistance Junction-case	Max	1.67	°C/W
R <sub>thj-amb</sub>	Thermal Resistance Junction-ambient	Max	70	°C/W

## ELECTRICAL CHARACTERISTICS (T<sub>case</sub> = 25 °C unless otherwise specified)

Symbol	Parameter	Test Conditions	Min.	Typ.	Max.	Unit	
I <sub>CB0</sub>	Collector Cut-off Current (I <sub>E</sub> = 0)	for <b>BD707/708</b> V <sub>CB</sub> = 60 V			100	μA	
		for <b>BD709/710</b> V <sub>CB</sub> = 80 V			100	μA	
		for <b>BD711/712</b> V <sub>CB</sub> = 100 V			100	μA	
		T <sub>case</sub> = 150 °C					
		for <b>BD707/708</b> V <sub>CB</sub> = 60 V			1	mA	
		for <b>BD709/710</b> V <sub>CB</sub> = 80 V			1	mA	
for <b>BD711/712</b> V <sub>CB</sub> = 100 V			1	mA			
I <sub>CEO</sub>	Collector Cut-off Current (I <sub>B</sub> = 0)	for <b>BD707/708</b> V <sub>CE</sub> = 30 V			100	mA	
		for <b>BD709/710</b> V <sub>CE</sub> = 40 V			100	mA	
		for <b>BD711/712</b> V <sub>CE</sub> = 50 V			100	mA	
I <sub>EBO</sub>	Emitter Cut-off Current (I <sub>C</sub> = 0)	V <sub>EB</sub> = 5 V			1	mA	
V <sub>CEO(sus)*</sub>	Collector-Emitter Sustaining Voltage (I <sub>B</sub> = 0)	I <sub>C</sub> = 100 mA	for <b>BD707/708</b> 60			V	
			for <b>BD709/710</b> 80			V	
			for <b>BD711/712</b> 100			V	
V <sub>CE(sat)*</sub>	Collector-Emitter Saturation Voltage	I <sub>C</sub> = 4 A I <sub>B</sub> = 0.4 A			1	V	
V <sub>CEK*</sub>	Knee Voltage	I <sub>C</sub> = 3 A I <sub>B</sub> = **			0.4	V	
V <sub>BE*</sub>	Base-Emitter Voltage	I <sub>C</sub> = 4 A V <sub>CE</sub> = 4 V			1.5	V	
h <sub>FE*</sub>	DC Current Gain	I <sub>C</sub> = 0.5 A V <sub>CE</sub> = 2 V	40	120	400		
		I <sub>C</sub> = 2 A V <sub>CE</sub> = 2 V	30				
		for <b>BD707/708</b>	30				
		for <b>BD709/710</b>	30				
		I <sub>C</sub> = 4 A V <sub>CE</sub> = 4 V	15		150		
		for <b>BD707/708</b>	15		150		
for <b>BD709/710</b>	15		150				
for <b>BD711/712</b>	15		150				
I <sub>C</sub> = 10 A V <sub>CE</sub> = 4 V	5	10					
for <b>BD707/708</b>		8					
for <b>BD709/710</b>		8					
for <b>BD711/712</b>		8					
f <sub>T</sub>	Transition frequency	I <sub>C</sub> = 300 mA V <sub>CE</sub> = 3 V	3			MHz	

\* Pulsed: Pulse duration = 300 μs, duty cycle 1.5 %

\*\* Value for which I<sub>C</sub> = 3.3 A at V<sub>CE</sub> = 2V.

For PNP types voltage and current values are negative.

Safe Operating Areas

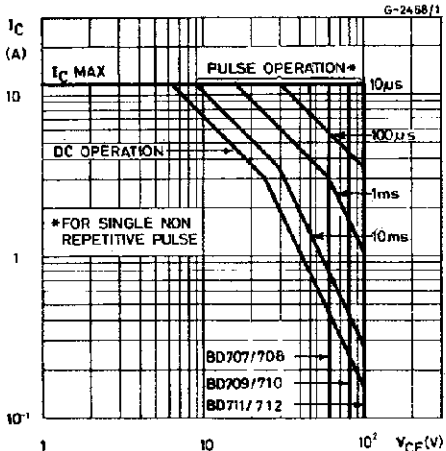

Derating Curve

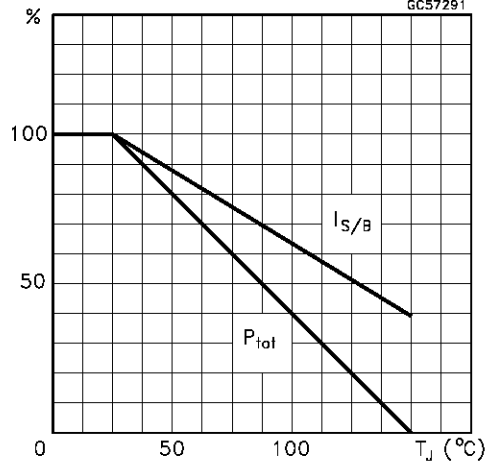

DC Current Gain(NPN type)

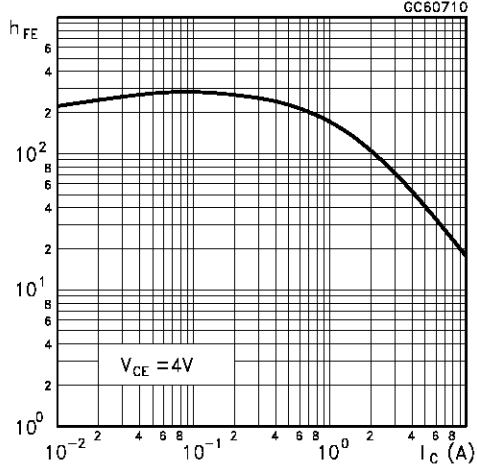

DC Current Gain(PNP type)

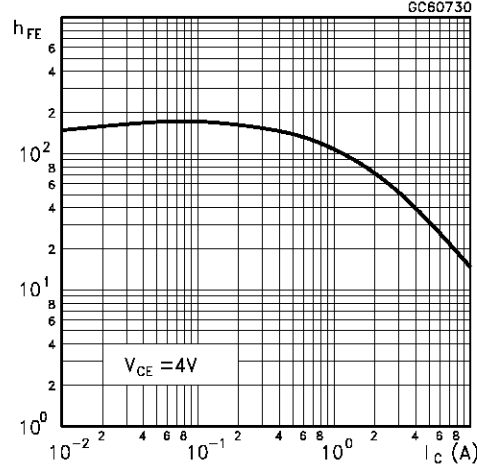

DC Transconductance(NPN type)

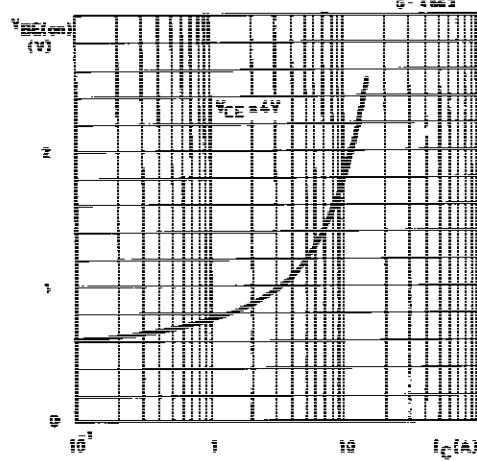

DC Transconductance(PNP type)

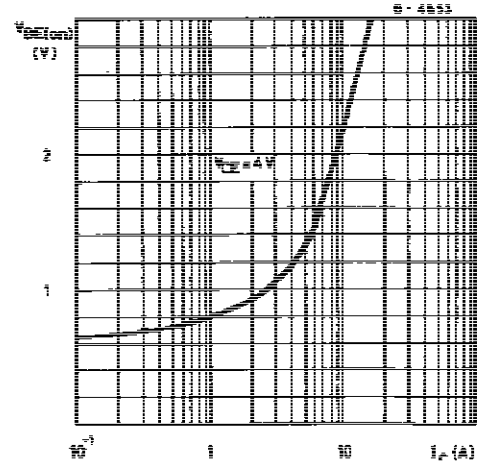

Collector-Emitter Saturation Voltage (NPN type)

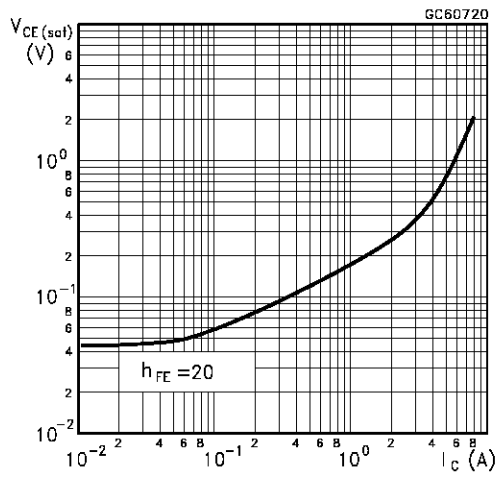

Collector-Emitter Saturation Voltage (PNP type)

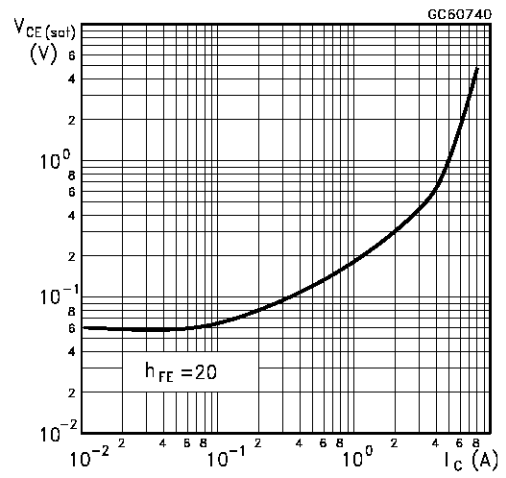

Base-Emitter Saturation Voltage (NPN type)

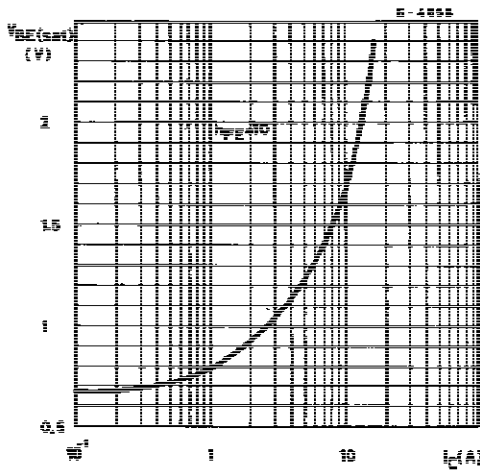

Base-Emitter Saturation Voltage (PNP type)

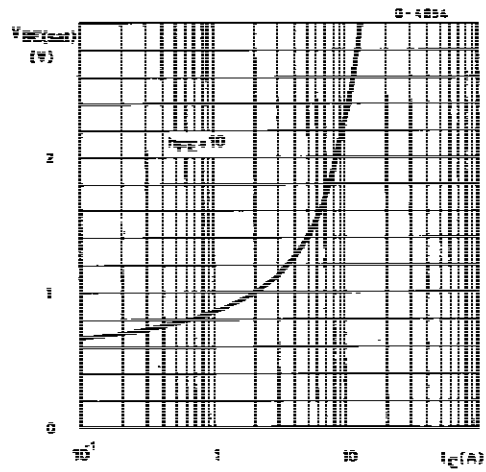

Transition Frequency (NPN type)

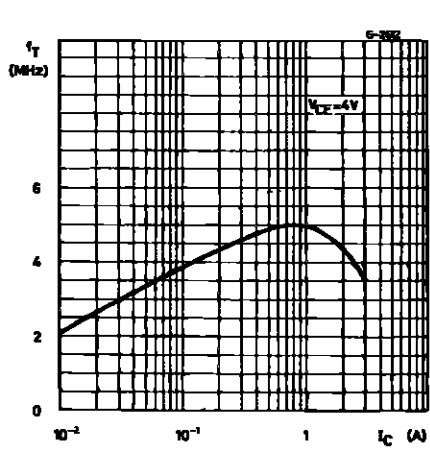

Transition Frequency (PNP type)

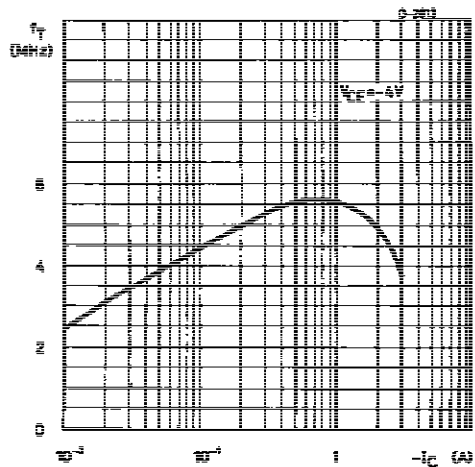

**TO-220 MECHANICAL DATA**

DIM.	mm			inch		
	MIN.	TYP.	MAX.	MIN.	TYP.	MAX.
A	4.40		4.60	0.173		0.181
C	1.23		1.32	0.048		0.051
D	2.40		2.72	0.094		0.107
D1		1.27			0.050	
E	0.49		0.70	0.019		0.027
F	0.61		0.88	0.024		0.034
F1	1.14		1.70	0.044		0.067
F2	1.14		1.70	0.044		0.067
G	4.95		5.15	0.194		0.203
G1	2.4		2.7	0.094		0.106
H2	10.0		10.40	0.393		0.409
L2		16.4			0.645	
L4	13.0		14.0	0.511		0.551
L5	2.65		2.95	0.104		0.116
L6	15.25		15.75	0.600		0.620
L7	6.2		6.6	0.244		0.260
L9	3.5		3.93	0.137		0.154
DIA.	3.75		3.85	0.147		0.151

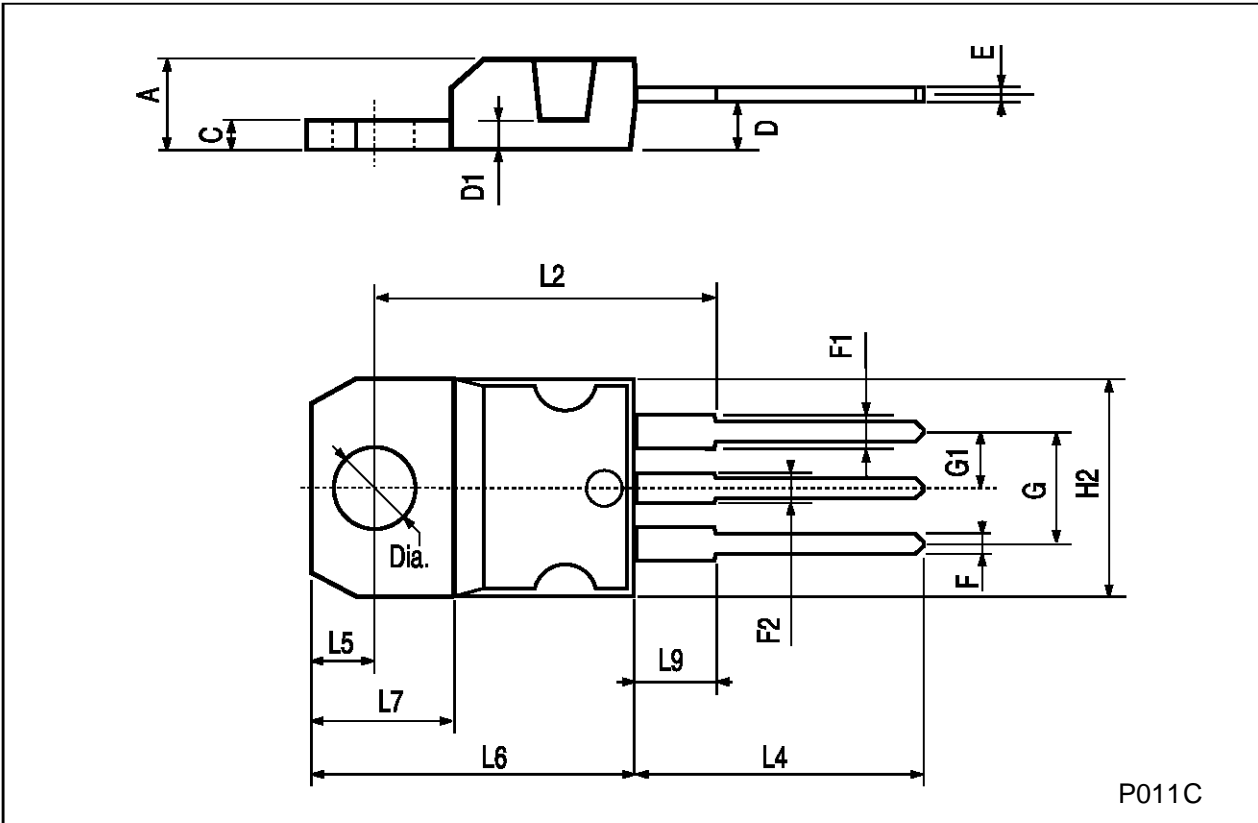

Information furnished is believed to be accurate and reliable. However, SGS-THOMSON Microelectronics assumes no responsibility for the consequences of use of such information nor for any infringement of patents or other rights of third parties which may result from its use. No license is granted by implication or otherwise under any patent or patent rights of SGS-THOMSON Microelectronics. Specifications mentioned in this publication are subject to change without notice. This publication supersedes and replaces all information previously supplied. SGS-THOMSON Microelectronics products are not authorized for use as critical components in life support devices or systems without express written approval of SGS-THOMSON Microelectronics.

© 1997 SGS-THOMSON Microelectronics - Printed in Italy - All Rights Reserved

SGS-THOMSON Microelectronics GROUP OF COMPANIES  
Australia - Brazil - Canada - China - France - Germany - Hong Kong - Italy - Japan - Korea - Malaysia - Malta - Morocco - The Netherlands -  
Singapore - Spain - Sweden - Switzerland - Taiwan - Thailand - United Kingdom - U.S.A  
...