

# Ultra high-speed switching diode array

## BAV70 / BAW56 / BAV99 / BAS16

\*This product is available only outside of Japan.

●Application

Ultra high speed switching

●Features

- 1) Compact size
- 2) High speed ( $t_{rr} = 1.5\text{ns Typ.}$ )
- 3) Four types of circuit configurations are available.

●Construction

Silicon epitaxial planar

●External dimensions (Units: mm)

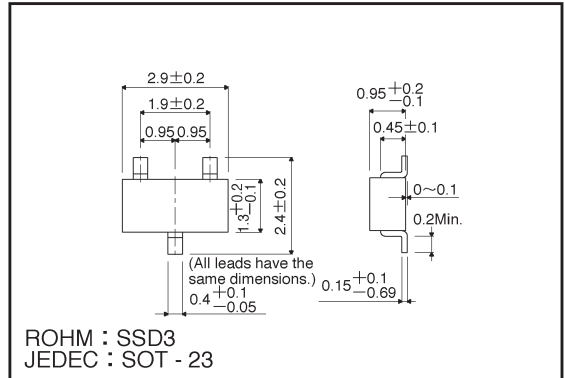

●Marking (TYPE No.)

Product name	Type No.	Product name	Type No.
BAV70	RA4	BAV99	RA7
BAW56	RA1	BAS16	RA6

(Ex.) BAV70



●Equivalent circuit

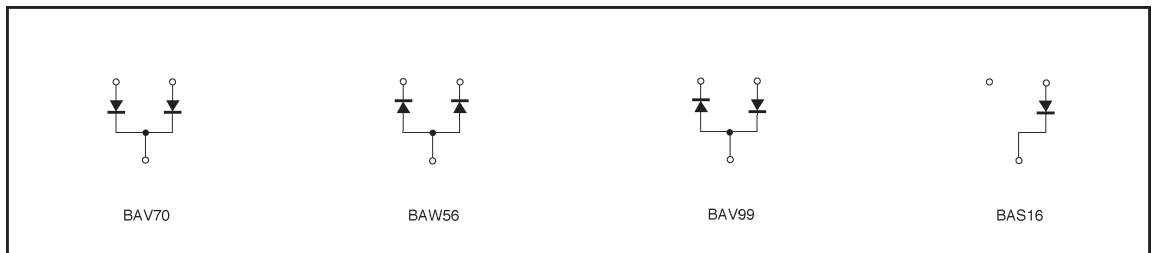

● Absolute maximum ratings (Ta = 25°C)

Type	Peak reverse voltage V <sub>RM</sub> (V)	DC reverse voltage V <sub>R</sub> (V)	Peak forward current I <sub>FM</sub> (mA)	Mean rectifying current I <sub>o</sub> (mA)	Surge current (1 μs) I <sub>surge</sub> (A)	Power dissipation (TOTAL) Pd (mW)	Junction temperature T <sub>J</sub> (°C)	Storage temperature T <sub>stg</sub> (°C)	TYPE
BAV70	80	80	300	100	4	200	150	-55~+150	N
BAW56	80	80	300	100	4	150	150	-55~+150	P
BAV99	80	80	300	100	4	200	150	-55~+150	N
BAS16	80	80	300	100	4	200	150	-55~+150	N

● Electrical characteristics (Ta = 25°C)

Type	Forward voltage		Reverse current		Capacitance between terminals			Reverse recovery time		
	V <sub>F</sub> (V) Max.	Cond.	I <sub>R</sub> (μA) Max.	Cond.	C <sub>T</sub> (pF) Max.	Cond.		t <sub>rr</sub> (ns) Max.	Cond.	
		I <sub>F</sub> (mA)		V <sub>R</sub> (V)		V <sub>R</sub> (V)	f (MHz)		V <sub>R</sub> (V)	I <sub>F</sub> (mA)
BAV70	1.2	100	0.1	70	3.5	6	1	4	6	5
BAW56	1.2	100	0.1	70	3.5	6	1	4	6	5
BAV99	1.2	100	0.1	70	3.5	6	1	4	6	5
BAS16	1.2	100	0.1	70	3.5	6	1	4	6	5

● Electrical characteristic curves (Ta = 25°C unless specified otherwise)

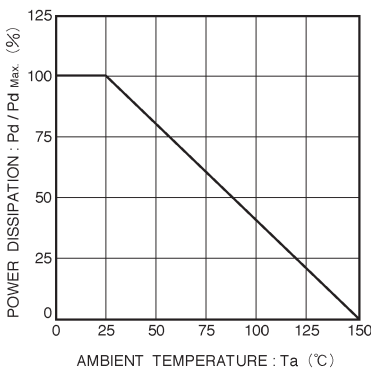

Fig. 1 Power attenuation curve

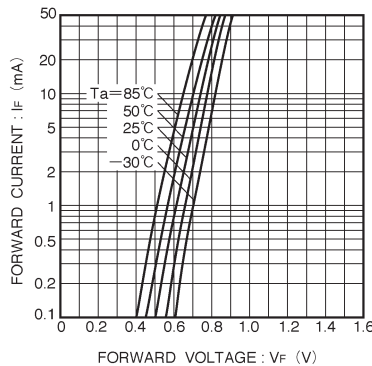

Fig. 2 Forward current vs. forward voltage (P TYPE)

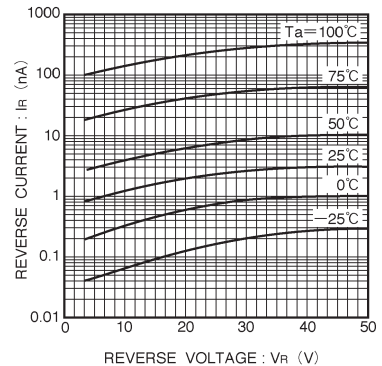

Fig. 3 Reverse current vs. reverse voltage (P TYPE)

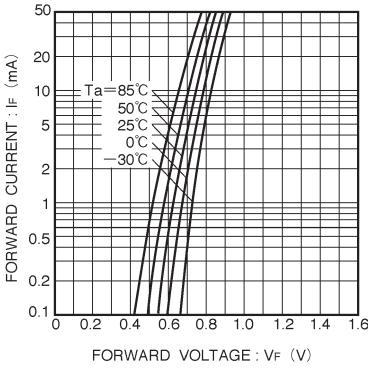

Fig. 4 Forward current vs. forward voltage (N TYPE)

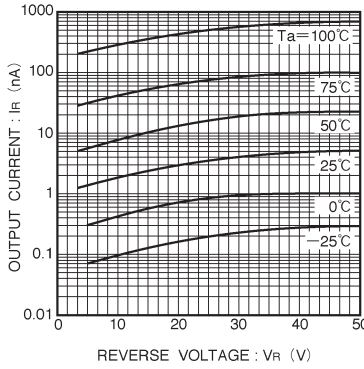

Fig. 5 Reverse current vs. reverse voltage (N TYPE)

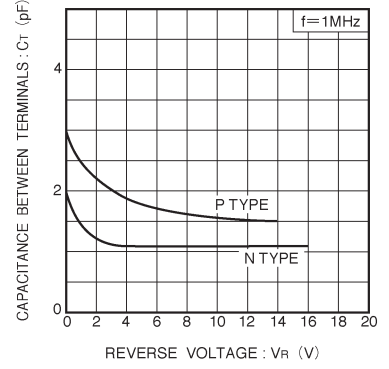

Fig. 6 Capacitance between terminals vs. reverse voltage

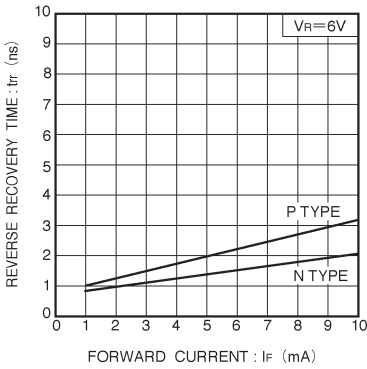

Fig. 7 Reverse recovery time vs. forward current

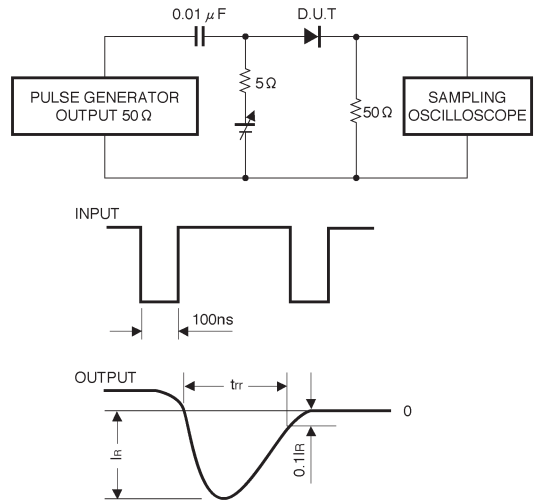

Fig. 8 Reverse recovery time ( $t_{rr}$ ) measurement circuit