

SMALL SIGNAL SCHOTTKY DIODES

DESCRIPTION

General purpose, metal to silicon diodes featuring very low turn-on voltage and fast switching.

These devices have integrated protection against excessive voltage such as electrostatic discharges.

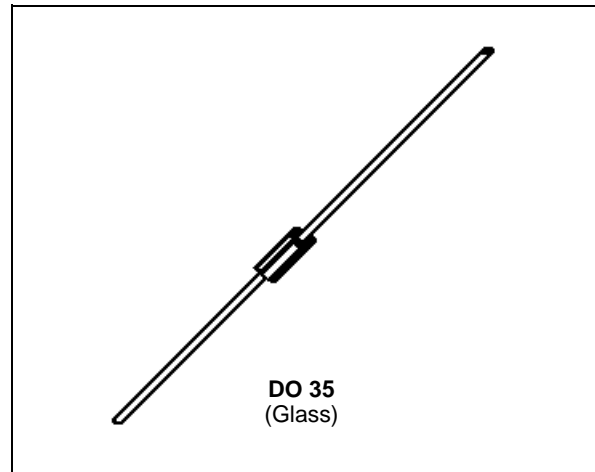

ABSOLUTE RATINGS (limiting values)

Symbol	Parameter	BAT47	BAT48	Unit
V_{RRM}	Repetitive Peak Reverse Voltage	20	40	V
I_F	Forward Continuous Current*	$T_a = 25\text{ °C}$ 350		mA
I_{FRM}	Repetitive Peak Forward Current*	$t_p \leq 1\text{ s}$ $\delta \leq 0.5$ 1		A
I_{FSM}	Surge non Repetitive Forward Current*	$t_p = 10\text{ ms}$ 7.5		A
		$t_p = 1\text{ s}$ 1.5		
P_{tot}	Power Dissipation*	$T_a = 25\text{ °C}$ 330		mW
T_{stg} T_j	Storage and Junction Temperature Range	- 65 to + 150 - 65 to + 125		°C °C
T_L	Maximum Temperature for Soldering during 10s at 4mm from Case	230		°C

THERMAL RESISTANCE

Symbol	Test Conditions	Value	Unit
$R_{th(j-a)}$	Junction-ambient*	300	°C/W

* On infinite heatsink with 4mm lead length

ELECTRICAL CHARACTERISTICS
STATIC CHARACTERISTICS

Symbol	Test Conditions		Min.	Typ.	Max.	Unit	
V _{BR}	I _R = 10μA	BAT47	20			V	
	I _R = 25μA	BAT48	40				
V _F *	T _j = 25°C I _F = 0.1mA	All Types			0.25	V	
	T _j = 25°C I _F = 1mA				0.3		
	T _j = 25°C I _F = 10mA				0.4		
	T _j = 25°C I _F = 30mA	BAT47			0.5		
	T _j = 25°C I _F = 150mA				0.8		
	T _j = 25°C I _F = 300mA				1		
	T _j = 25°C I _F = 50mA	BAT48			0.5		
	T _j = 25°C I _F = 200mA				0.75		
	T _j = 25°C I _F = 500mA				0.9		
I _R *	T _j = 25°C	V _R = 1.5V	All Types			1	μA
	T _j = 60°C					10	
	T _j = 25°C	V _R = 10V	BAT47			4	
	T _j = 60°C					20	
	T _j = 25°C	V _R = 20V				10	
	T _j = 60°C					30	
	T _j = 25°C	V _R = 10V	BAT48			2	
	T _j = 60°C					15	
	T _j = 25°C	V _R = 20V				5	
	T _j = 60°C					25	
	T _j = 25°C	V _R = 40V				25	
	T _j = 60°C					50	

DYNAMIC CHARACTERISTICS

Symbol	Test Conditions		Min.	Typ.	Max.	Unit
C	T _j = 25°C V _R = 0V	f = 1MHz		20		pF
	T _j = 25°C V _R = 1V			12		
t _{rr}	T _j = 25°C I _F = 10mA	V _R = 1V i _{rr} = 1mA R _L = 100Ω		10		ns

* Pulse test: t_p ≤ 300μs δ < 2%.

Figure 1. Forward current versus forward voltage at different temperatures (typical values).

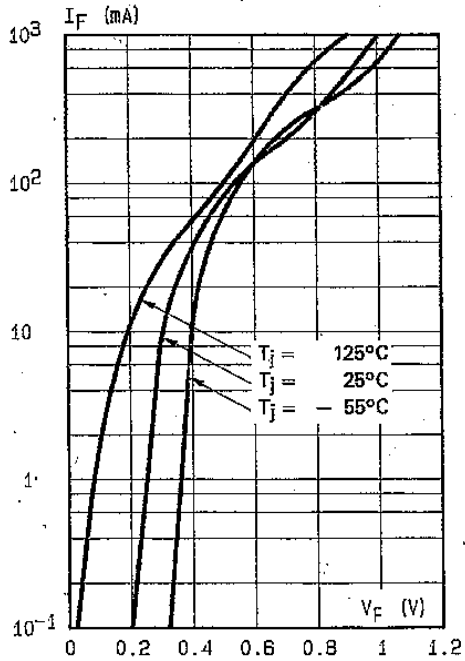

Figure 2. Forward current versus forward voltage (typical values).

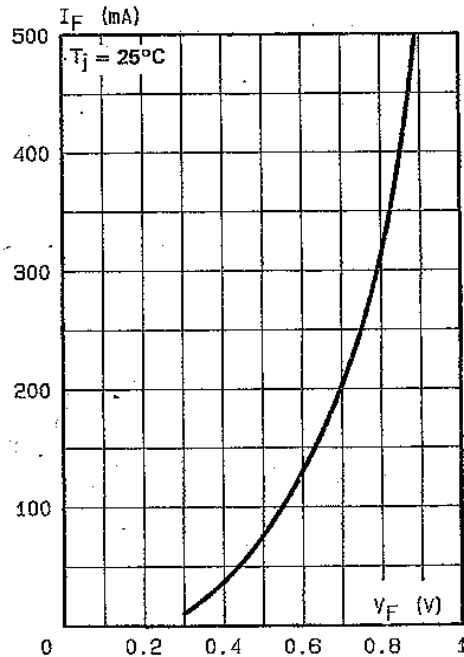

Figure 3. Reverse current versus junction temperature.

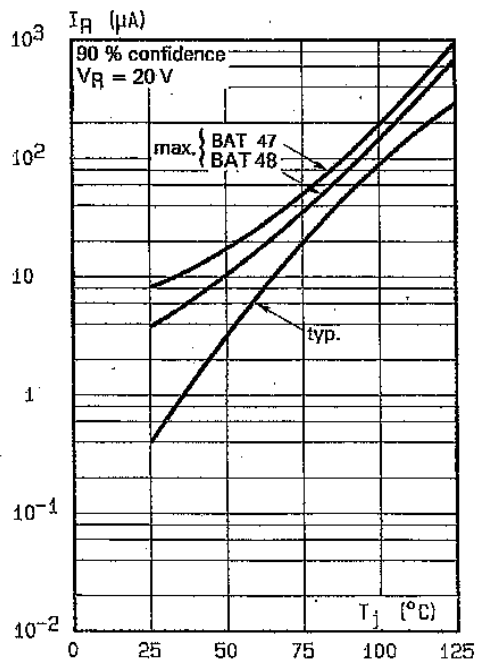

Figure 4. Reverse current versus continuous reverse voltage (typical values).

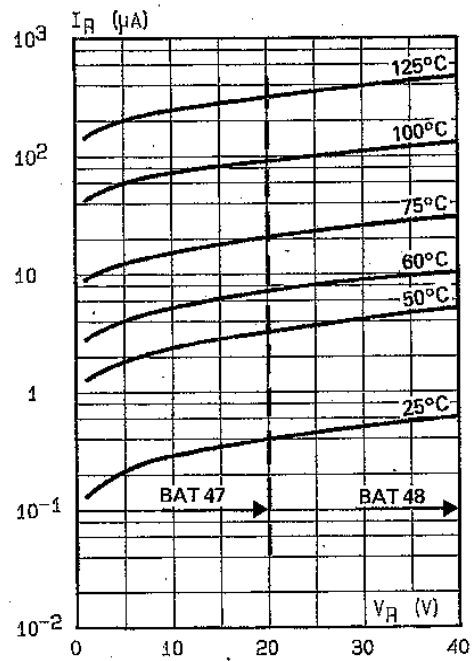
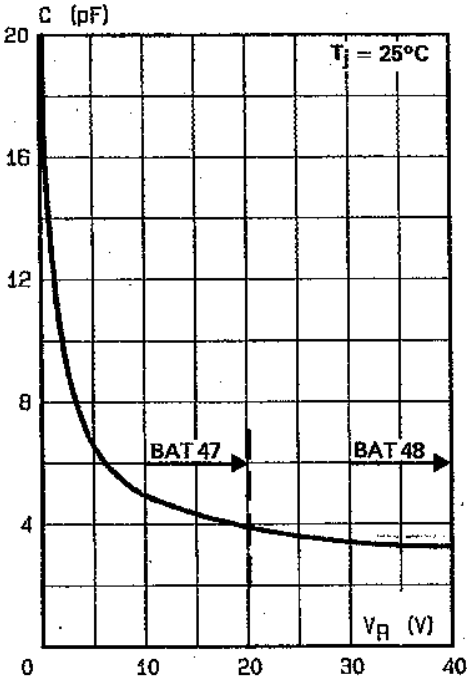
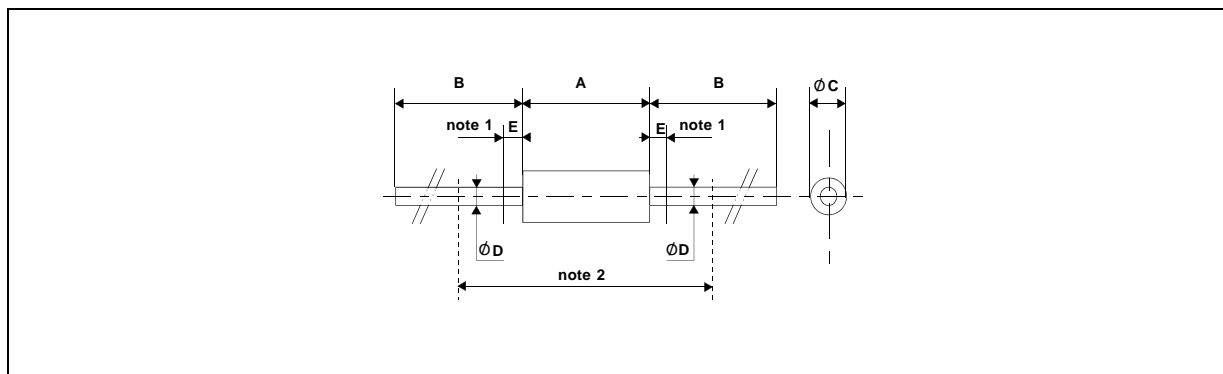

Figure 5. Capacitance C versus reverse applied voltage V_R (typical values).



PACKAGE MECHANICAL DATA

DO 35 Glass



REF.	DIMENSIONS				NOTES
	Millimeters		Inches		
	Min.	Max.	Min.	Max.	
A	3.050	4.500	0.120	0.117	1 - The lead diameter $\varnothing D$ is not controlled over zone E 2 - The minimum axial length within which the device may be placed with its leads bent at right angles is 0.59" (15 mm)
B	12.7		0.500		
$\varnothing C$	1.530	2.000	0.060	0.079	
$\varnothing D$	0.458	0.558	0.018	0.022	
E		1.27		0.050	

Cooling method: by convection and conduction.
 Marking: clear, ring at cathode end.
 Weight: 0.015g

Information furnished is believed to be accurate and reliable. However, SGS-THOMSON Microelectronics assumes no responsibility for the consequences of use of such information nor for any infringement of patents or other rights of third parties which may result from its use. No license is granted by implication or otherwise under any patent or patent rights of SGS-THOMSON Microelectronics. Specifications mentioned in this publication are subject to change without notice. This publication supersedes and replaces all information previously supplied. SGS-THOMSON Microelectronics products are not authorized for use as critical components in life support devices or systems without express written approval of SGS-THOMSON Microelectronics.

© 1994 SGS-THOMSON Microelectronics - Printed in Italy - All rights reserved.

SGS-THOMSON Microelectronics GROUP OF COMPANIES

Australia - Brazil - France - Germany - Hong Kong - Italy - Japan - Korea - Malaysia - Malta - Morocco - The Netherlands
 Singapore - Spain - Sweden - Switzerland - Taiwan - United Kingdom - U.S.A.