

● Absolute maximum ratings (Ta=25°C)

Parameter	Symbol	Limits	Unit
Applied voltage	V _{CCMax}	10.5 *1	V
Power dissipation	P _{dMax}	1250 *2	mW
Operating temperature	T _{opr}	-15 ~ 65	°C
Storage temperature	T _{stg}	-40 ~ 150	°C
Pin 2 input voltage	V _{P2Max}	10.5	V

*1 27 Ω resistor connected between V_{CC} and V_{REG}.

*2 When IC is stand alone, reduced by 12.5mW for each increase in Ta of 1°C over 25°C.

● Recommended operating conditions (Ta=25°C)

Parameter	Symbol	Limits	Unit
Power supply voltage (9V)	V _{CC 9V}	8.8 ~ 9.2 *1	V
Power supply voltage (12V)	V _{CC 12V}	11.7 ~ 12.3 *2	V

*1 27 Ω resistor connected between V_{CC} and V_{REG}.

*2 62 Ω resistor connected between V_{CC} and V_{REG}.

● Pin description

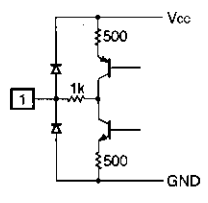
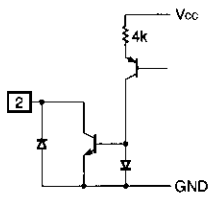
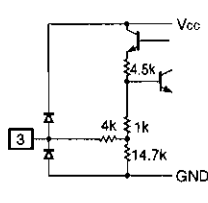
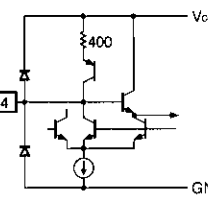
Pin No.	Pin Name	IN / OUT	Standard voltage	Equivalent circuit	Function
1	AF - TOUT	OUT	—		AFT output. VREG/GND push-pull output.
2	RF - AGC	OUT	—		RF-AGC output. Open-collector output. Gain can be set using an external resistor (minimum value of the maximum sink current of pin 2 is 0.7mA). Keep the pin 2 voltage at 10.5V or less.
3	AGC - ADJ	—	2.1V (when 100kΩ resistor connected)		RF-AGC delay point adjustment. Connect to GND via a variable resistor (approx. 100kΩ).
4	AGC - FLT	—	5.0V		For filter time constant for VIF AGC.
5	GND1		0V		GND for VIF, AGC and AFT.

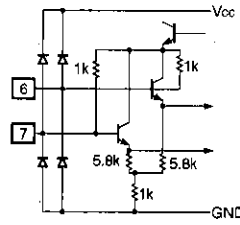
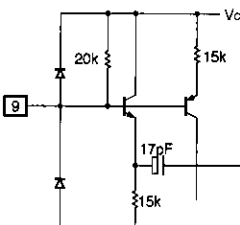
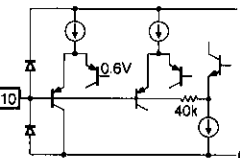
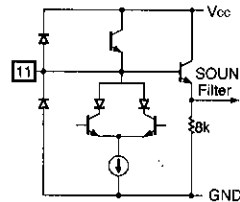
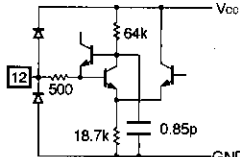
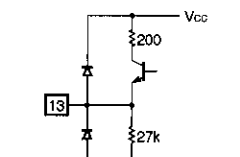
Pin No.	Pin Name	IN / OUT	Standard voltage	Equivalent circuit	Function
6 7	VIFB VIFA	IN	4.2V		Video IF input. Use with balanced input.
8	GND2	—	0V		SIF and PLL GND.
9	SIF	IN	6.6V		Audio IF input. Can set to intercarrier mode by pulling down via a 2k Ω resistor.
10	AFC	—	2.7V		Holding the audio output DC level fixed. Connect to GND via a 4.7 μ F capacitor and to VREG via a 10 μ F capacitor to reduce buzz. Set this pin to 0.3V or lower to apply audio/video mute.
11	VO - 4.5M	—	5.2V		2nd SIF output. Connect a trap to this pin to vary the sound filter characteristics. The internal impedance is a high 1k Ω , so connect a buffer to output.
12	IR	—	2.4V		Reference current source for adjusting the internal filter. Use connected to GND via a 24k Ω resistor. Use an accurate resistor with good temperature characteristics (e.g. $\pm 1\%$ metal film).
13	AFOUT	OUT	3.2V		Audio signal output. The standard output in the case of B/G is 520mVrms (when $f = 50\text{kHz}$). Connect to GND via a 10k Ω resistor.

Pin No.	Pin Name	IN / OUT	Standard voltage	Equivalent circuit	Function
14	X5	—	5.0V		For connection to a 5MHz oscillator (when M format is used). Use as a reference oscillator for automatic adjustment of the internal filter, and as the signal for the SIF signal low frequency conversion. (B/G, D/K format: 6MHz, I format: 6.5MHz).
15	MODE	IN	3.4V		Input Trap Filter switch. 0V: M format (4.5MHz) 2.4V: D/K format (6.5MHz) 4.3V: I format (6.0MHz) VREG: B/G format (5.5MHz)
16 17	PLL - COILA PLL - COILB	—	3.6V		For connection of IF detector VCO oscillator coil.
18	VREG	—	6.6V		IF circuit power supply. Pin 18 has a built-in shunt regulator.
19	AFT - COIL	—	3.0V		For connection of AFT coil. To apply AFT defeat, connect to GND via a 1kΩ (approx.) resistor.
20	PLL - FLT	—	3.4V		Time constant circuit for the PLL filter.
21	VEQO	OUT	2.0V (SYNC)		VIDEO output. Output is via the sound trap, B/W noise inverter, and EQ AMP. Connect to GND via a 4.7kΩ resistor.
22	EQFLT	—	5.2V		EQ Filter. Connect to GND via an LCR series resonant circuit. R should be $\geq 1k\Omega$

* Vcc and Vcc2 in the equivalent circuit diagrams are connected to the VREG pin (pin 18).

●Electrical characteristics (Unless otherwise specified Ta=25°C, Vcc=9V, and P=38.9MHz)

Parameter	Symbol	Min.	Typ.	Max.	Unit	Conditions	
(VREG)							
Circuit current	I _{CC}	—	92	105	mA		
Regulated voltage	V _{REG}	6.2	6.6	7.0	V		
(VIF)							
Input sensitivity	V _{VMin.}	38	43	48	dB μ	V _{VO} = -3dB point	
Maximum allowable input level	V _{VMax.}	100	110	—	dB μ	V _{VO} = +1dB point	
AGC range	GR	62	66	—	dB	V _{VO} = \pm 3dB range	
Quiescent video output voltage	V _{P21}	3.9	4.3	4.7	V	No signal, V _{P4} = V _{REG}	
Video detector output level	V _{VO}	1.7	2.0	2.4	V _{P-P}	V _i = 80dB μ , AM87.5%MOD	
Synchronous signal tip voltage	V _{P21SY}	1.7	2.0	2.3	V	100% white video signal	
Video output DG	DG	—	2	8	%	V _i = 80dB μ , AM87.5%MOD	
Video output DP	DP	—	3	8	deg	3STEP video signal	
Sound Trap attenuation	M, B / G	G _{VOS}	33	45	—	dB	20 * LOG (V _{OS} / V _{O0.2M})
	D / K, I		28	45	—		
920kHz beat level	I ₉₂₀	37	44	—	dB	P=0, P / C=4, P / S=14dB	
Video output S/N	S / N _v	47	53	—	dB	V _i = 90dB μ , 100% white	
White noise threshold voltage	V _{WTH}	4.7	5.0	5.3	V	CW = 70dB μ frequency variation and pin 21 voltage variation	
White noise clamp voltage	V _{WCL}	2.9	3.2	3.5	V		
Black noise threshold voltage	V _{BTH}	1.1	1.4	1.7	V		
Black noise clamp voltage	V _{BCL}	2.6	2.9	3.2	V		
RFAGC maximum sink current	I _{P2SI}	0.7	1.2	—	mA	CW=100dB μ , AGCADJ=100k	
(AFT)							
Maximum AFT voltage	V _{P1Max.}	6.0	6.4	—	V	CW=38.4MHz	
Minimum AFT voltage	V _{P1Min.}	—	0.3	0.8	V	CW=39.4MHz	
AFT detection sensitivity	S _i	35	50	—	mV / kHz	CW frequency variation	
AFT defeat starting voltage	V _{AFTDET}	—	—	1.2	V	CW=38.4MHz	
AFT defeat voltage	V _{1DEF}	2.9	3.3	3.6	V	CW=38.4MHz	
(PLL)							
PLL capture range 1	f _{CU}	0.6	+1.2	—	MHz	CW = 80dB μ frequency variation	
PLL capture range 2	f _{CL}	—	-1.2	-0.6	MHz		
PLL lock range 1	f _{LU}	0.6	+1.3	—	MHz		
PLL lock range 2	f _{LL}	—	-1.3	-0.6	MHz		
VCO control sensitivity	β	0.5	1.0	—	kHz / mV		

● Application example

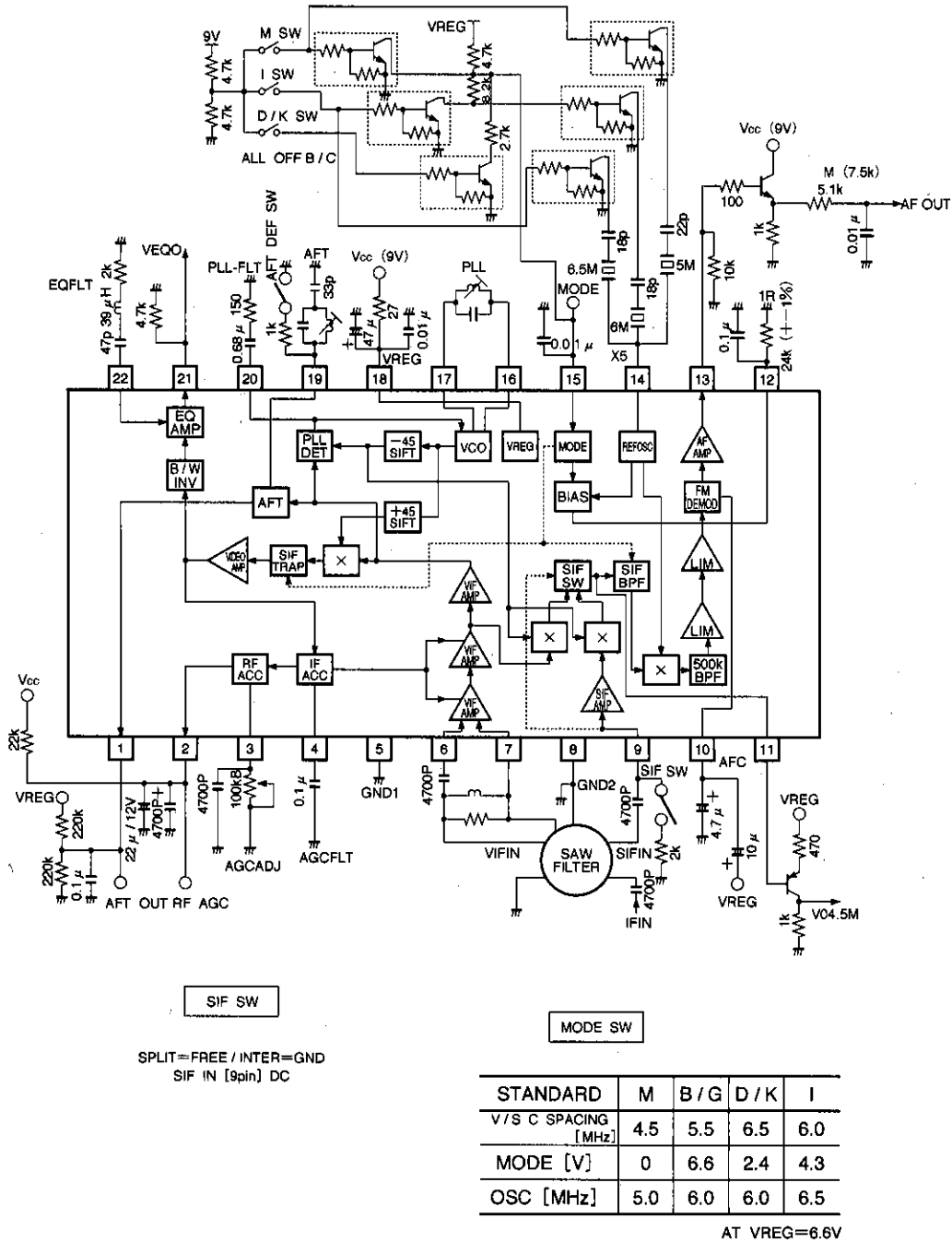

Fig.2

● Operation notes

- Simultaneous audio and video output muting function
It is possible to simultaneously mute the audio and video output by pulling the AFC filter pin down.
- AFT defeat function
AFT defeat can be applied by pulling the AFT coil pin down via a 1kΩ resistor.
- Recommended SIF input range for intercarrier mode P/S=20 to 30dB (including SAW-FILTER).
- IF input range for RF-AGC switching
60 to 95dB μ.
- Intercarrier mode switching
Intercarrier mode can be set by pulling the SIF pin down via a 2kΩ resistor.
- IR pin external resistor
This resistor sets the filter system reference current, so use an accurate component that has good temperature characteristics.

- Adjustment of the evaluation board
Before performing measurements, adjust the coils as described below.

1. VCO coil

Lower the VIF input level, and apply a voltage of AGCFLT=6V. Monitor the PLL-FIL voltage (V1). Next, input a signal of VIFIN=80dB μ, 38.9MHz, and with the AGCFLT free, adjust the VCO so that the voltage at this time, V2, becomes the same as V1.

2. AFT coil

Input a signal of VIFIN=80dB μ, 38.9MHz, set the AFT defeat switch to open, and monitor the AFT output pin voltage. Rotate the AFT coil, adjust the output voltage to 1/2VREG (Typ. 3.3V) at the point where the output voltage changes steeply.

● External dimensions (Units: mm)

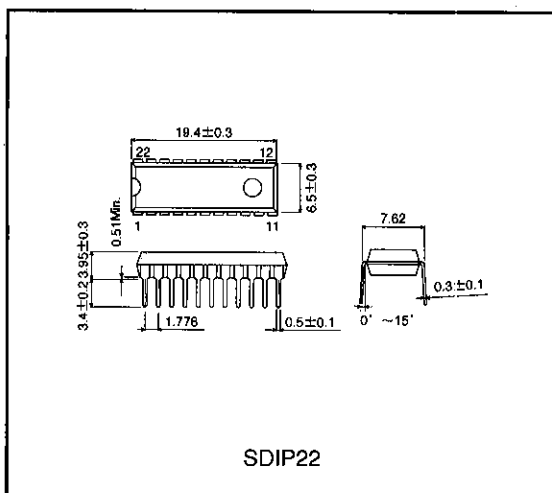

Notes

- The contents described in this catalogue are correct as of March 1997.
- No unauthorized transmission or reproduction of this book, either in whole or in part, is permitted.
- The contents of this book are subject to change without notice. Always verify before use that the contents are the latest specifications. If, by any chance, a defect should arise in the equipment as a result of use without verification of the specifications, ROHM CO., LTD., can bear no responsibility whatsoever.
- Application circuit diagrams and circuit constants contained in this data book are shown as examples of standard use and operation. When designing for mass production, please pay careful attention to peripheral conditions.
- Any and all data, including, but not limited to application circuit diagrams, information, and various data, described in this catalogue are intended only as illustrations of such devices and not as the specifications for such devices. ROHM CO., LTD., disclaims any warranty that any use of such device shall be free from infringement of any third party's intellectual property rights or other proprietary rights, and further, assumes absolutely no liability in the event of any such infringement, or arising from or connected with or related to the use of such devices.
- Upon the sale of any such devices; other than for the buyer's right to use such devices itself, resell or otherwise dispose of the same; no express or implied right or license to practice or commercially exploit any intellectual property rights or other proprietary rights owned or controlled by ROHM CO., LTD., is granted to any such buyer.
- The products in this manual are manufactured with silicon as the main material.
- The products in this manual are not of radiation resistant design.

The products listed in this catalogue are designed to be used with ordinary electronic equipment or devices (such as audio-visual equipment, office-automation equipment, communications devices, electrical appliances, and electronic toys). Should you intend to use these products with equipment or devices which require an extremely high level of reliability and the malfunction of which would directly endanger human life (such as medical instruments, transportation equipment, aerospace machinery, nuclear-reactor controllers, fuel controllers, or other safety devices) please be sure to consult with our sales representative in advance.

- Note when exporting
 - It is essential to obtain export permission when exporting any of the above products when it falls under the category of strategic material (or labor) as determined by foreign exchange or foreign trade control laws.
 - Please be sure to consult with our sales representatives to ascertain whether any product is classified as a strategic material.