

Reversible motor driver

BA6246N/BA6247/BA6247N/BA6247FP-Y

The BA6246N, BA6247, BA6247N, and BA6247FP-Y are monolithic ICs incorporating two reversible-motor drivers. The ICs differ in the control logic and output mode.

● Features

- 1) Two reversible-motor drivers in each unit.
- 2) Built-in thermal shutdown circuit.
- 3) Output voltage can be set arbitrarily.
- 4) Available in a compact SIP10pin package (BA6246N, BA6247N) or a HSIP10pin package with radiation fins (BA6247).
- 5) Available in a HSOP25pin surface-mount package (BA6247FP-Y).

● Block diagram

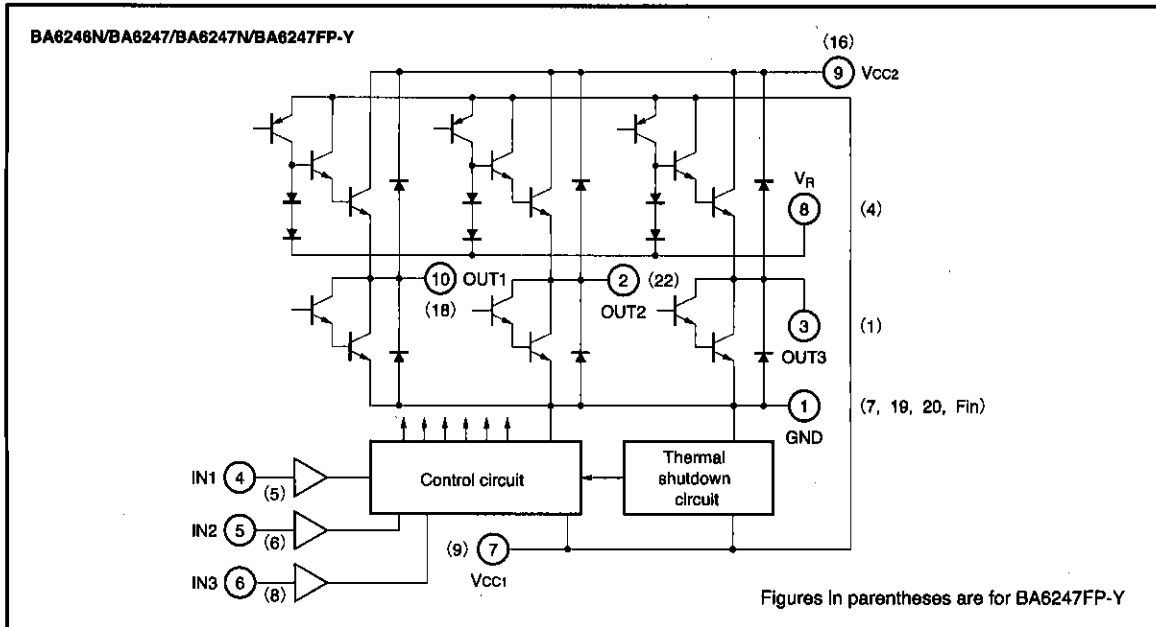

●Control pin equivalent circuits

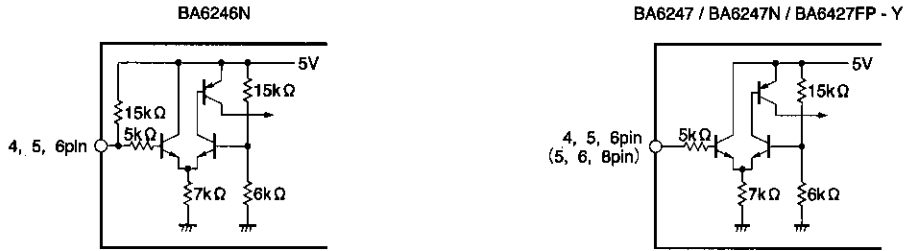

Fig.1

●Input/output truth table

Input			Output					
Common to all units			BA6246N			BA6247/BA6247N/BA6247FP-Y		
IN1	IN2	IN3	OUT1	OUT2	OUT3	OUT1	OUT2	OUT3
L	L	L	L	L	L	L	L	L
		H	L	L	L	L	L	L
H	L	L	H	L	OPEN	H	L	OPEN
H	L	H	L	H	OPEN	L	H	OPEN
L	H	L	H	OPEN	L	H	OPEN	L
L	H	H	L	OPEN	H	L	OPEN	H
H	H	L	OPEN	OPEN	OPEN	L	L	L
		H	OPEN	OPEN	OPEN	L	L	L

●Absolute maximum ratings (Ta=25°C)

Parameter	Symbol	Limits			Unit
		BA6246N BA6247N	BA6247	BA6247FP - Y	
Power supply voltage	V _{cc}	20	20	20	V
Power dissipation	P _d	1000*1	2000*3	1450*4	mW
Operating temperature	T _{opr}	-25~75	-25~75	-25~75	°C
Storage temperature	T _{stg}	-55~125	-55~150	-55~150	°C
Input voltage	V _{IN}	-0.2~6	-0.2~6	-0.2~6	V
Output current	I _o	1.0*2	1.0*2	1.0*2	A

*1 Reduce power by 10 mW for each degree above 25 °C.

*2 50 ms pulse with a duty ratio of 1/50

*3 Reduce power by 16.0 mW for each degree above 25 °C.

*4 When a glass epoxy PCB (90 X 50 X 1.6 mm) is used; reduce power by 11.6 mW for each degree above 25 °C.

●Electrical characteristics (Unless otherwise noted, Ta=25°C and Vcc=12V)

Parameter	Symbol	Min.	Typ.	Max.	Unit	Conditions
Operating supply voltage	Vcc1, Vcc2	8	—	18	V	—
Output reference voltage	V _R	—	—	18	V	—
Current consumption	I _{cc}	—	7	15	mA	IN1=IN2=IN3= "L"
		—	10	20		
LOW level input voltage	V _{IL}	—	—	1.0	V	
HIGH level input voltage	V _{IH}	3.5	—	—	V	
LOW level output voltage	V _{OL}	—	0.9	1.5	V	V _R : OPEN, I _o =0.5A
HIGH level output voltage	V _{OH}	10.0	10.5	—	V	V _R : OPEN, I _o =0.5A
Output offset voltage	V _{o16}	-0.5	0	0.5	V	V _R =6V, I _o =0.5A Difference between V _R and the output voltage
Pin 8 (pin 14) source current	I ₈ (I ₁₄)	0.5	0.8	1.6	mA	V _R =6V, I _o =0.5A

●Application example

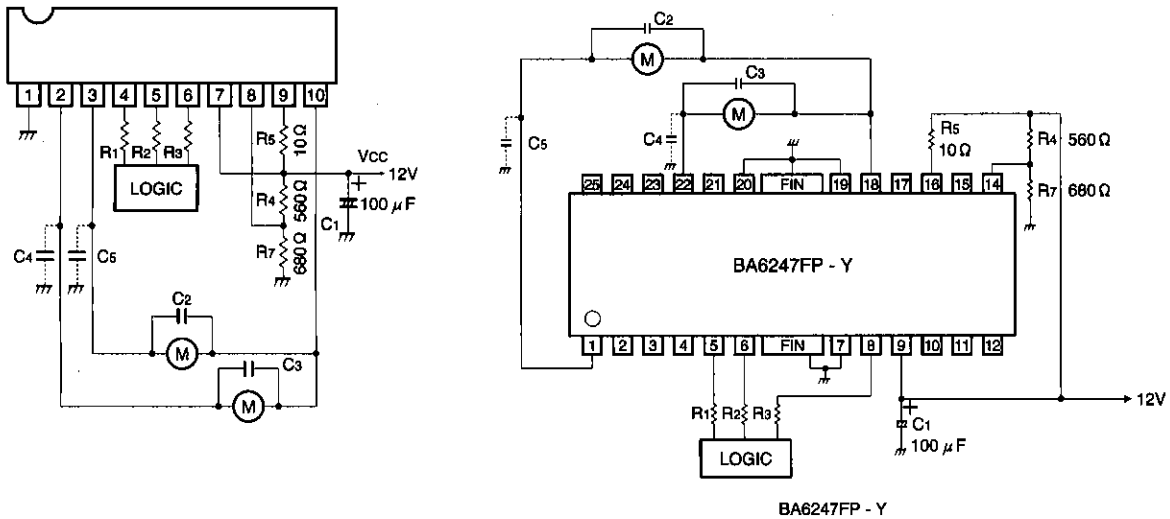

C2, C3: Capacitors for preventing parasitic oscillation. Though the optimum capacitance depends on such PCB arrangement factors as the power supply circuit, motor characteristics, and conductor foil patterns, a range of 0.01-1 μF is recommended.

C4, C5: Capacitors for preventing parasitic oscillation. They may or may not be required, depending on the PCB arrangement. A capacitance range of 0.01-10 μF is recommended.

Fig.2 Application circuits for a motor with ratings of 6 V and 100 mA (Vcc = 12 V)

● Operation notes

(1) Input conditions

1) The input threshold voltage is positively correlated with temperature as expressed by :

$$\frac{\Delta V_{IH}}{\Delta T} \cong +2.8\text{mV}/^\circ\text{C}$$

$$\frac{\Delta V_{IL}}{\Delta T} \cong +1.6\text{mV}/^\circ\text{C} \text{ (Typ.)}$$

2) The input pins of the BA6246N are pulled up through a resistance of about 15kΩ (see Fig. 1). To secure the LOW level input, the interface to these pins should have a current-sink capability of at least 700 μA (5V/15kΩ×2).

3) The maximum input voltage is 6V. Make sure that the input will not exceed this value.

(2) Changes in motor direction

When reversing the rotational direction of a motor, make sure to go through the brake or open mode in-between the opposite directions.

The duration of brake mode should be more than the

braking time, which is defined by the time required for the potential of the LOW level output pin to become less than the ground potential by the electromotive force generated when the mode is switched from rotation to brake.

The duration of open mode should be 1 ms or more.

(3) Due to the effects of capacitors C₂~C₅, the motor that is not being driven could be momentarily driven during mode switching. Check for this problem when designing your application.

(4) It is recommendable to arrange your design so that voltage rises at V_{CC1} prior to V_{CC2} when turning on the power, and voltage falls at V_{CC1} after V_{CC2} when turning off the power.

(5) Thermal shutdown circuit

When the thermal shutdown circuit is activated, the outputs are left OPEN. The circuit is activated when the IC junction temperature rises above 170°C. The temperature difference between the activation and deactivation settings is about 30°C.

● Power dissipation curves

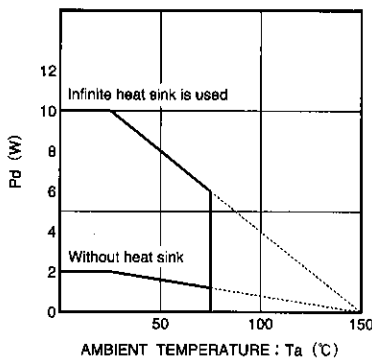

Fig.3 Power dissipation curves (BA6247)

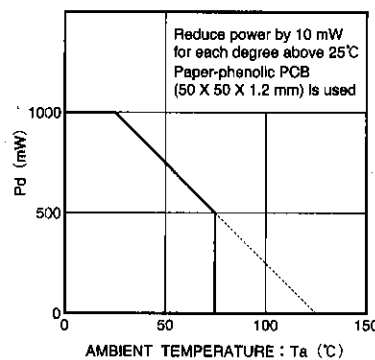

Fig.4 Power dissipation curve (BA6246N, BA6247N)

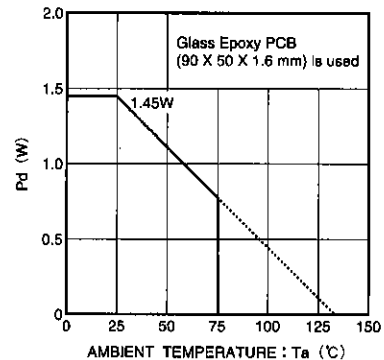

Fig.5 Power dissipation curve (BA6247FP-Y)

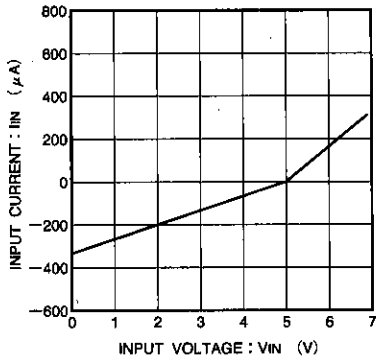

Fig.6 Input voltage vs. input current (BA6246N)

● Electrical characteristic curves

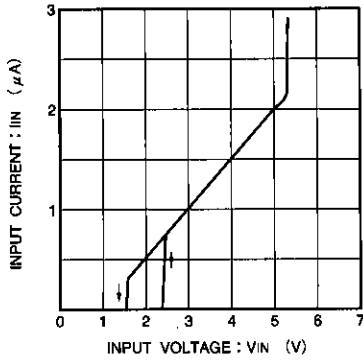

Fig.7 Input voltage vs. input current (BA6247,BA6247N,BA6247FP-Y)

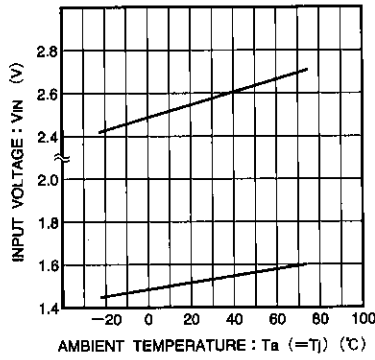

Fig.8 Input voltage vs. ambient temperature

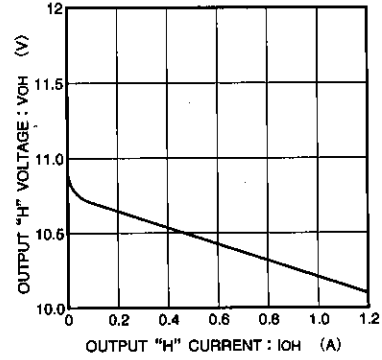

Fig.9 HIGH level output voltage vs. output current

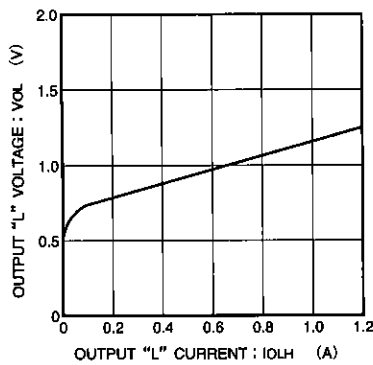

Fig.10 LOW level output voltage vs. output current

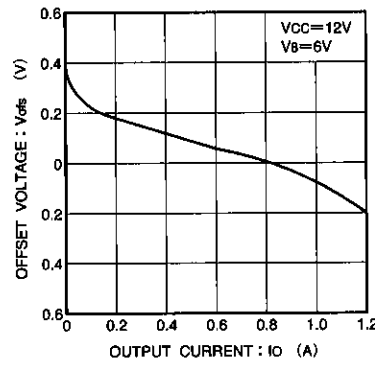

Fig.11 Offset voltage vs. output current

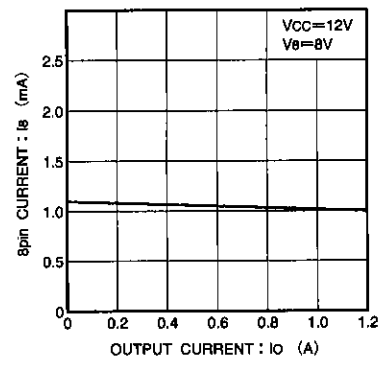
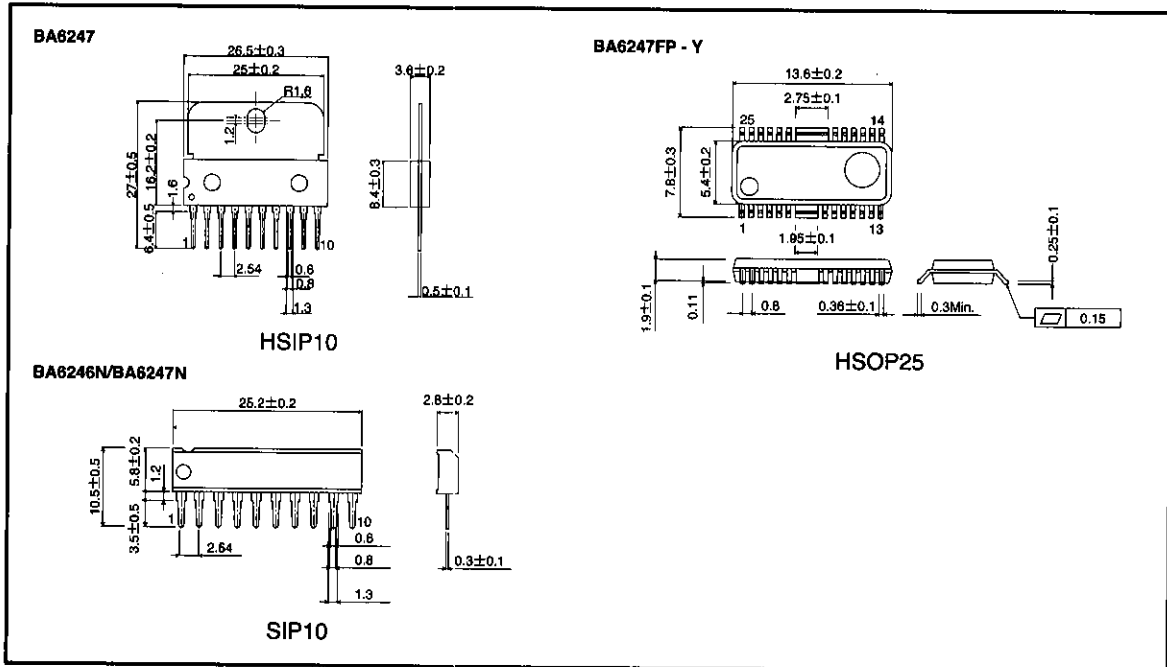

Fig.12 Pin-8 current vs. output current

● External dimensions (Units: mm)



Notes

- The contents described in this catalogue are correct as of March 1997.
- No unauthorized transmission or reproduction of this book, either in whole or in part, is permitted.
- The contents of this book are subject to change without notice. Always verify before use that the contents are the latest specifications. If, by any chance, a defect should arise in the equipment as a result of use without verification of the specifications, ROHM CO., LTD., can bear no responsibility whatsoever.
- Application circuit diagrams and circuit constants contained in this data book are shown as examples of standard use and operation. When designing for mass production, please pay careful attention to peripheral conditions.
- Any and all data, including, but not limited to application circuit diagrams, information, and various data, described in this catalogue are intended only as illustrations of such devices and not as the specifications for such devices. ROHM CO., LTD., disclaims any warranty that any use of such device shall be free from infringement of any third party's intellectual property rights or other proprietary rights, and further, assumes absolutely no liability in the event of any such infringement, or arising from or connected with or related to the use of such devices.
- Upon the sale of any such devices; other than for the buyer's right to use such devices itself, resell or otherwise dispose of the same; no express or implied right or license to practice or commercially exploit any intellectual property rights or other proprietary rights owned or controlled by ROHM CO., LTD., is granted to any such buyer.
- The products in this manual are manufactured with silicon as the main material.
- The products in this manual are not of radiation resistant design.

The products listed in this catalogue are designed to be used with ordinary electronic equipment or devices (such as audio-visual equipment, office-automation equipment, communications devices, electrical appliances, and electronic toys). Should you intend to use these products with equipment or devices which require an extremely high level of reliability and the malfunction of which would directly endanger human life (such as medical instruments, transportation equipment, aerospace machinery, nuclear-reactor controllers, fuel controllers, or other safety devices) please be sure to consult with our sales representatives in advance.

- Notes when exporting
 - It is essential to obtain export permission when exporting any of the above products when it falls under the category of strategic material (or labor) as determined by foreign exchange or foreign trade control laws.
 - Please be sure to consult with our sales representatives to ascertain whether any product is classified as a strategic material.