

FM front end

BA4402 / BA4404

The BA4402 and BA4404 are front end ICs for FM radio receivers. These devices can be used in a wide range of applications, from 3V portable radios to home stereo tuners.

The BA4402 and BA4404 consist of an RF amplifier, oscillator circuit, mixer circuit, and a variable capacitor-diode for AFC. They are pin compatible, and either can be selected depending on the amount of gain needed and other requirements of the application.

●Applications

- FM pocket radios
- Radio cassette players
- Home stereos

●Features

- 1) Wide operating voltage range : 1.8 to 9V.
- 2) High gain with good stability.
- 3) An appropriate device can be selected depending on the need for AFC and the amount of gain required.

●Block diagram

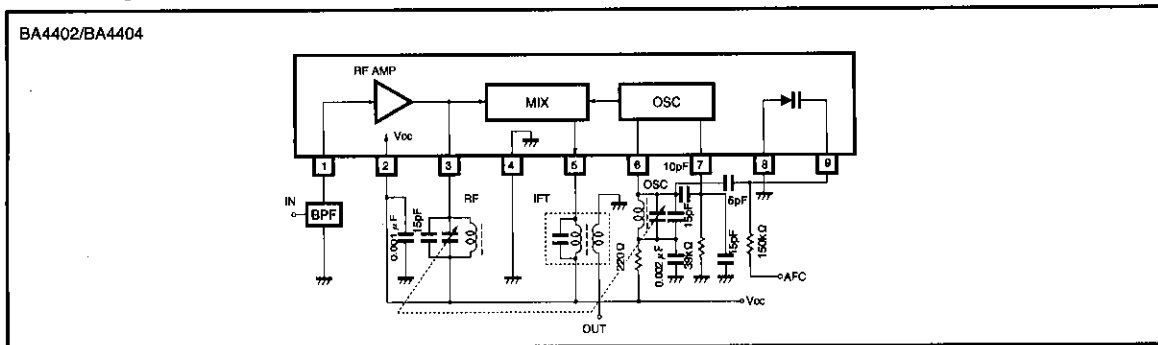

Product name	Variable capacitor	Gain	RF amplifier
BA4402	Yes	32dB	Common base
BA4404	Yes	38dB	Common emitter

● Absolute maximum ratings (Ta = 25°C)

Parameter	Symbol	Limits	Unit
Supply voltage	V _{CC}	9	V
Power dissipation	P _d	1000*1	mW
Operating temperature	T _{opr}	-25~75	°C
Storage temperature	T _{stg}	-55~125	°C

* 1 At temperatures above Ta = 25°C, decreases 10 mW per degree.

● Electrical characteristics (unless otherwise indicated, Ta = 25°C and V_{CC} = 3V)

BA4402

Parameter	Symbol	Min.	Typ.	Max.	Unit	Conditions	Measurement Circuit
Quiescent current	I _Q	—	2.5	4.0	mA	—	Fig.1
Output voltage 1	V _{O1}	25	40	55	mV	f _{IN} =100MHz, 60dB μV	Fig.1
Output voltage 2	V _{O2}	80	120	160	mV	f _{IN} =100MHz, 100dB μV	Fig.1
Oscillator voltage	V _{OSC}	180	250	340	mV	V _{CC} =2V	Fig.1
Oscillation stop voltage	V _{STOP}	—	1.4	1.6	V	—	Fig.1

BA4404

Parameter	Symbol	Min.	Typ.	Max.	Unit	Conditions	Measurement Circuit
Quiescent current	I _Q	—	3.0	5.0	mA	—	Fig.1
Output voltage 1	V _{O1}	55	80	120	mV	f _{IN} =100MHz, 60dB μV	Fig.1
Output voltage 2	V _{O2}	80	120	160	mV	f _{IN} =100MHz, 100dB μV	Fig.1
Oscillator voltage	V _{OSC}	180	250	340	mV	V _{CC} =2V	Fig.1
Oscillation stop voltage	V _{STOP}	—	1.4	1.6	V	—	Fig.1

Front end

High-frequency signal processors

● Measurement circuit

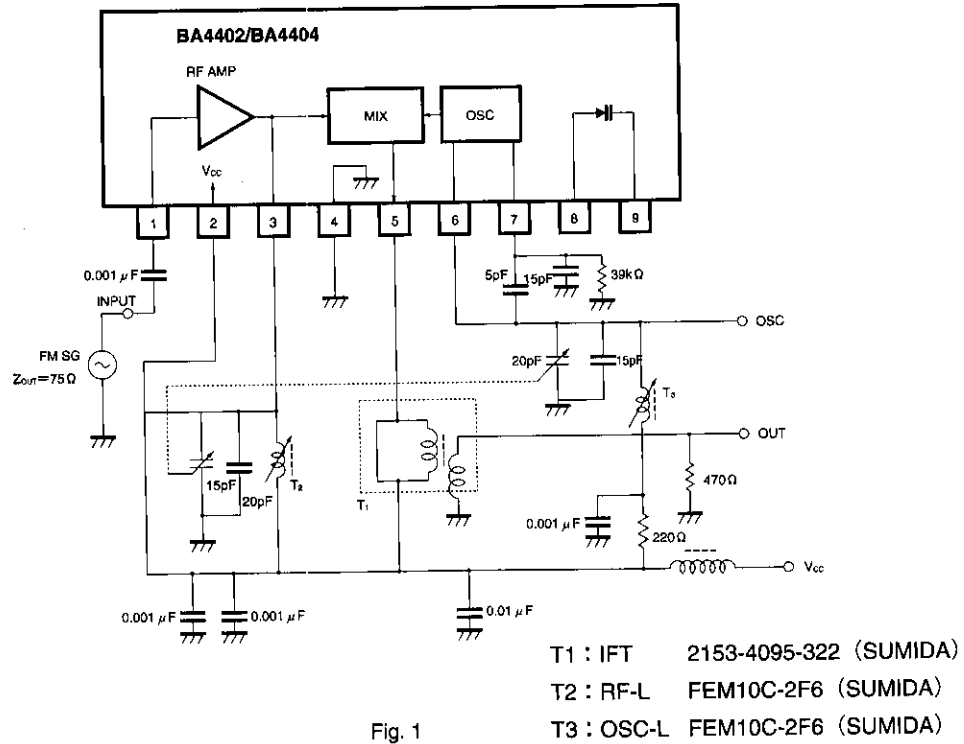

Fig. 1

● Application example

BA4402/BA4404

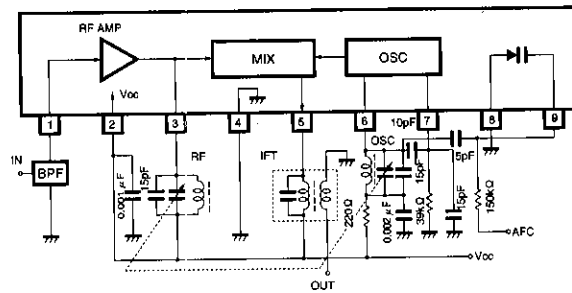

Fig. 2

●Electrical characteristic curves

BA4402

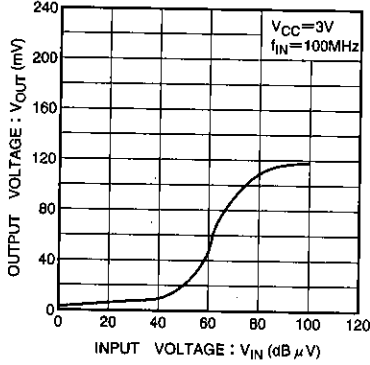

Fig. 3 Output voltage vs. input voltage

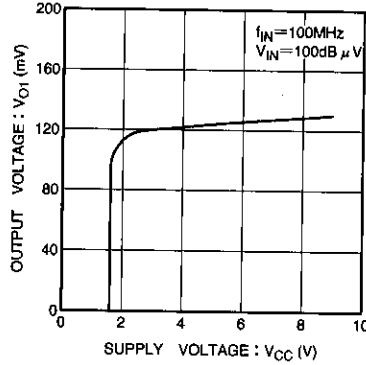

Fig. 4 Output voltage 1 vs. supply voltage

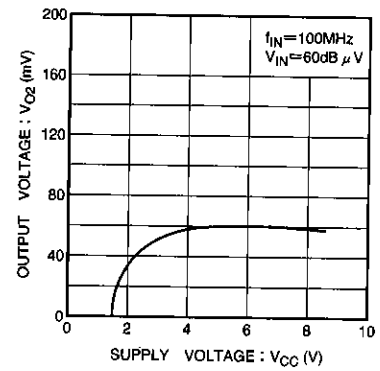

Fig. 5 Output voltage 2 vs. supply voltage

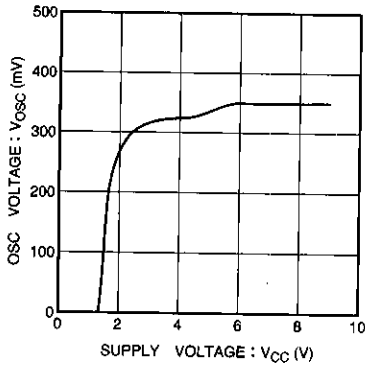

Fig. 6 Oscillator voltage vs. supply voltage

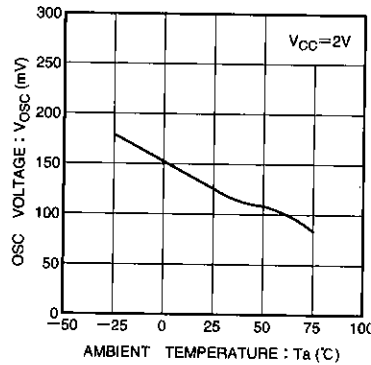

Fig. 7 Oscillator voltage vs. ambient temperature

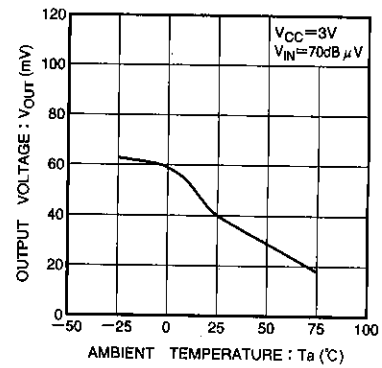

Fig. 8 Output voltage vs. ambient temperature

BA4404

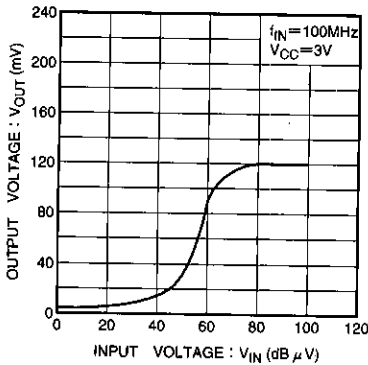

Fig. 9 Output voltage vs. input voltage

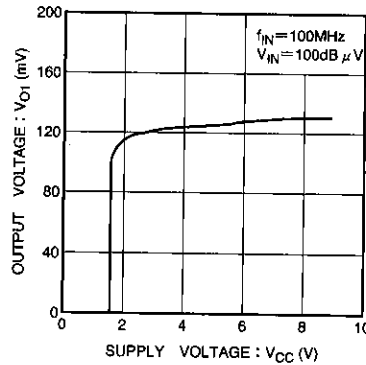

Fig. 10 Output voltage 1 vs. supply voltage

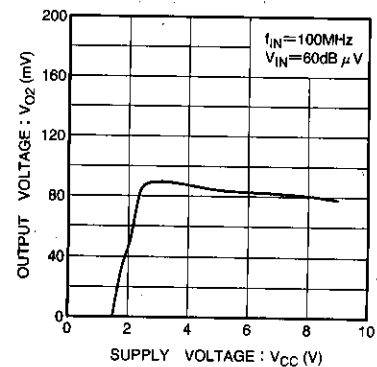

Fig. 11 Output voltage 2 vs. supply voltage

Front end

High-frequency signal processors

BA4404

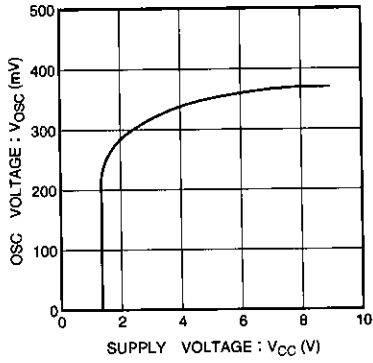

Fig. 12 Oscillator voltage vs. supply voltage

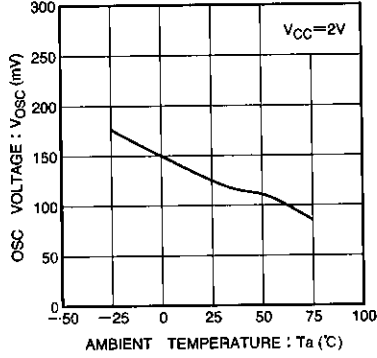

Fig. 13 Oscillator voltage vs. ambient temperature

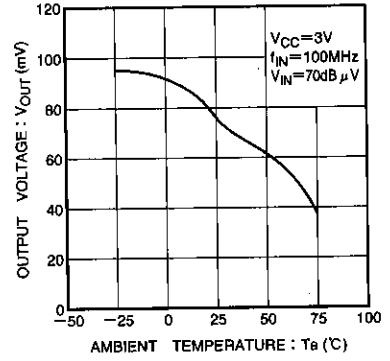

Fig. 14 Output voltage vs. ambient temperature

BA4402/BA4404

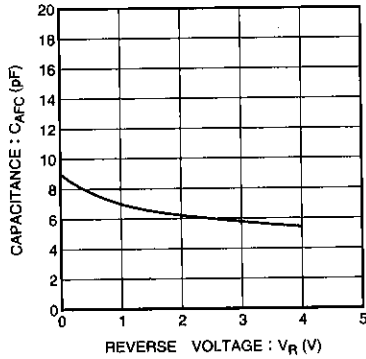
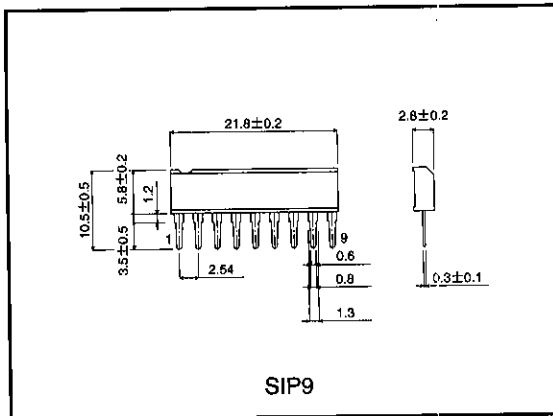

Fig. 15 AFC capacitor capacitance vs. applied voltage

● External dimensions (Unit: mm)



Notes

- The contents described in this catalogue are correct as of March 1997.
- No unauthorized transmission or reproduction of this book, either in whole or in part, is permitted.
- The contents of this book are subject to change without notice. Always verify before use that the contents are the latest specifications. If, by any chance, a defect should arise in the equipment as a result of use without verification of the specifications, ROHM CO., LTD., can bear no responsibility whatsoever.
- Application circuit diagrams and circuit constants contained in this data book are shown as examples of standard use and operation. When designing for mass production, please pay careful attention to peripheral conditions.
- Any and all data, including, but not limited to application circuit diagrams, information, and various data, described in this catalogue are intended only as illustrations of such devices and not as the specifications for such devices. ROHM CO., LTD., disclaims any warranty that any use of such device shall be free from infringement of any third party's intellectual property rights or other proprietary rights, and further, assumes absolutely no liability in the event of any such infringement, or arising from or connected with or related to the use of such devices.
- Upon the sale of any such devices; other than for the buyer's right to use such devices itself, resell or otherwise dispose of the same; no express or implied right or license to practice or commercially exploit any intellectual property rights or other proprietary rights owned or controlled by ROHM CO., LTD., is granted to any such buyer.
- The products in this manual are manufactured with silicon as the main material.
- The products in this manual are not of radiation resistant design.

The products listed in this catalogue are designed to be used with ordinary electronic equipment or devices (such as audio-visual equipment, office-automation equipment, communications devices, electrical appliances, and electronic toys). Should you intend to use these products with equipment or devices which require an extremely high level of reliability and the malfunction of which would directly endanger human life (such as medical instruments, transportation equipment, aerospace machinery, nuclear-reactor controllers, fuel controllers, or other safety devices) please be sure to consult with our sales representatives in advance.

- Notes when exporting
 - It is essential to obtain export permission when exporting any of the above products when it falls under the category of strategic material (or labor) as determined by foreign exchange or foreign trade control laws.
 - Please be sure to consult with our sales representatives to ascertain whether any product is classified as a strategic material.