

# Pre-power amplifier for headphone stereos

## BA3612AKV

The BA3612AKV is configured of a pre-amplifier and a headphone amplifier, and contains internal AMS, B.B, AVLS, and BEEP amplifier functions. Also, this IC can be used in combination with the BA3641FV to enable configuration of recording and playback sets.

### ●Applications

Portable cassette players

### ●Features

- 1) Low current consumption.
- 2) Internal AMS function.
- 3) Internal B.B function.
- 4) Internal AVLS function.
- 5) Internal BEEP amplifier.
- 6) Supports Dolby-B.
- 7) Supports OCL output.

### ●Absolute maximum ratings (Ta = 25°C)

Parameter	Symbol	Limits	Unit
Power supply voltage	V <sub>DD</sub>	5.0	V
Power dissipation	P <sub>d</sub>	400*	mW
Operating temperature	T <sub>opr</sub>	-15~+60	°C
Storage temperature	T <sub>stg</sub>	-55~+125	°C

\*Reduced by 4.0mW for each increase in Ta of 1°C over 25°C.  
when mounted on a 70mm × 70mm × 1.6mm glass epoxy board.

### ●Recommended operating conditions (Ta = 25°C)

Parameter	Symbol	Limits	Unit
Power supply voltage 1	+B	0.90~2.20	V
Power supply voltage 2	V <sub>CC</sub>	1.70~4.40*	V

\* In terms of basic operation, normally a high voltage of 0.4V higher than +B is applied for V<sub>CC</sub>.  
A relation of V<sub>CC</sub>=+B × 2 is recommended.

●Block diagram

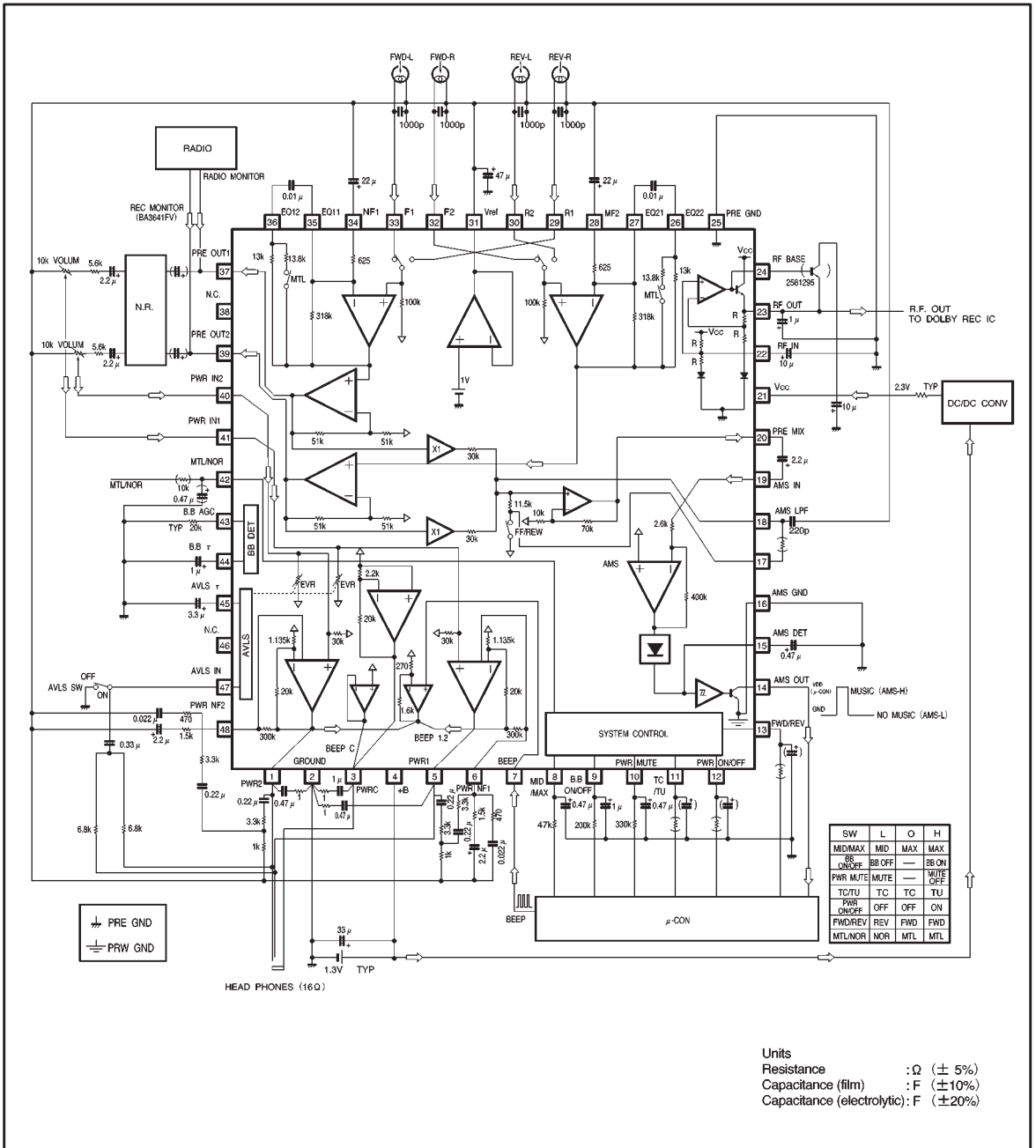

● Pin descriptions

(The pin voltage of  $V_{CC} = 2.3V$ ,  $+B = 1.3V$  is the standard value for the measurement circuit under quiescent conditions.

Modes: PWR-ON, TC, FWD, NOR, Mute-OFF, B.B-OFF, AVLS-OFF)

Pin No	Pin name	DC voltage	Equivalent circuit	Function
1 5	PWR2 PWR1	0.6		Power amplifier output BEEP amplifier output $Z_o \cong 1.2 \Omega$ (power amplifier)
8 48	PWR NF1 PWR NF2	1.0		NF pin when power amplifier is B.B
2	GROUND	0		PWR GND (Sub)
3	PWR C	0.6		Power amplifier output (Center amplifier) $Z_o \cong 6.7 \Omega$
4	+B	1.3		Positive power supply
7	BEEP	1.0		BEEP input $Z_{in} \cong 200k \Omega$
8	B.B MID / MAX	— (OPEN) 0.65 (MAX) 0.2 (MID)		For bass boost MID / MAX switching
13	Forward Reverse	— (OPEN) 0.65 (FWD)		Pre-amplifier forward/reverse input switching
42	Metal / Normal	— (OPEN) 0.2 (NOR)		Pre-amplifier equalizer switching between Metal ( $70 \mu s$ ) and Normal ( $120 \mu s$ )

Pin No.	Pin name	DC voltage	Equivalent circuit	Function
9	B.B ON / OFF	— (OPEN)  0.3 (B.B-OFF)		Bass boost/normal switching
10	MUTE	— (OPEN)  0.65 (MUTE-OFF)		Mute ON/OFF switching Zin = 100kΩ
11	TC / TU	0 (OPEN)  0.4 (TC)		Switching between TC (tape playback) and TU (radio monitor) Zin ≈ 100kΩ
12	ST-BY (PWR ON / OFF)	0 (OPEN)  0.77 (PWR-ON)		IC power supply ON/OFF Zin ≈ 100kΩ
14	AMSOUT	— (when curve exists)  0 (when no curve exists)		Mute detector output Non-mute: High Mute : Low
15	AMS DET	0 (when curve exists)  0.65 (when no curve exists)		Mute detector comparator output smoothing pin
16	AMS GND	0 *		Dedicated mute detector block GND

\*When GND is connected outside IC

Pin No.	Pin name	DC voltage	Equivalent circuit	Function
17	AMS LVL	1.0		Threshold value adjustment pin for mute detector high-speed mode
18	AMS LPF	1.0		Filter configuration pin to prevent malfunction from mute detector noise $Z_{in} \approx 1.5k\Omega$ (for playback) $Z_{in} \approx 7k\Omega$ (for fast forward / rewind)
20	PRE MIX	1.0		Output pin which amplifies PRE OUT MIX output to 18 dB
19	AMS IN	1.0		Phase detection amplifier input for mute detector block
21	V <sub>cc</sub>	2.3		Positive power supply (booster voltage)
22	RF IN	1.2		Ripple filter amplifier input $Z_{in} \approx 44k\Omega$
23	RF OUT	2.0		Ripple filter amplifier output $Z_{in} \approx 56.4k\Omega$

Pin No.	Pin name	DC voltage	Equivalent circuit	Function
24	RF Base	1.3		<p>For connection of external transistor for ripple filter amplifier. 2SB1295 or equivalent is recommended as external transistor. See diagram below for connection.</p>
25	Pre GND	0*		Low-current GND in IC
26	EQ22	1.0		Pre-amplifier equalizer Connect capacitors between pins 26 and 27 and between pins 35 and 36.
36	EQ12	1.0		Pre-amplifier equalizer
27	EQ21	1.0		Pre-amplifier NF
35	EQ11	1.0		
28	NF2	1.0		
34	NF1	1.0		
29	R1	1.0		Pre-amplifier reverse-1 channel input
30	R2	1.0		Pre-amplifier reverse-2 channel input
32	F2	1.0		Pre-amplifier forward-2 channel input
33	F1	1.0		Pre-amplifier forward-1 channel input
31	Vref	1.0		Vref amplifier output $Z_o \cong 10 \Omega$

\*When GND is connected outside IC

Pin No.	Pin name	DC voltage	Equivalent circuit	Function
37 39	Pre OUT1 Pre OUT2	1.0 1.0		Pre-amplifier output $Z_o \approx 130 \Omega$ (for TC) $Z_o = 100k \Omega$ (for TU)
40 41	PWR IN2 PWR IN1	1.0 1.0		Power amplifier input $Z_{in} = 30k \Omega$
43	B.B AGC	—		Controls AGC level during bass boost
44	B.B $\tau$	0		AGC phase detection output smoothing pin during bass boost

Pin No.	Pin name	DC voltage	Equivalent circuit	Function
45	AVLS $\tau$	0		Detector output smoothing pin during AVLS
47	AVLS IN	1.0		AVLS input AVLS ON / OFF switching



## ●Electrical characteristics

(unless otherwise noted, +B = 1.3V, V<sub>CC</sub> = 2.3V, f = 1kHz, PreOut<sub>L</sub> = 5k $\Omega$ , PWROut<sub>L</sub> = 16 $\Omega$  (OCL), Ta = 25°C, and measurement condition pertaining to ripple: V<sub>CC</sub> and +B are common-mode input)

Parameter	Symbol	Min.	Typ.	Max.	Unit	Coniditions	
〈Total〉							
Quiescent current	lcc1B	—	3.0	4.5	mA	Power On, PWR-Mute OFF, TC B.B-OFF, AVLS-OFF	
	lcc1V	—	4.9	6.0			
	lcc2B	—	0.3	0.8	mA	Power On, PWR-Mute ON, TC B.B-OFF, AVLS-OFF	
	lcc2V	—	4.1	5.5			
	lcc3B	—	3.0	4.5	mA	Power On, PWR-Mute OFF, Tuner B.B-OFF, AVLS-OFF	
	lcc3V	—	4.2	5.5			
	lcc4B	—	0	5.0	$\mu$ A	Power OFF, PWR-Mute OFF, TC B.B-OFF, AVLS-OFF	
lcc4V	—	0	5.0				
Current consumption at 0.5mW	lcc5B	—	14.0	15.5	mA	PWR input = -45.8dBV OCL, TC, B.B-OFF, AVLS-OFF	
	lcc5V	—	4.9	6.0			
〈Pre block〉							
Closed-loop voltage gain	Gvc1	34.6	35.6	36.6	dB	V <sub>o</sub> = -20.0dBv	
Max. output voltage	Vom1	185	250	—	mV	+B=0.9V, V <sub>CC</sub> =1.7V, THD=1%	
Total harmonic distortion	THD1	—	0.12	0.5	%	+B=0.9V, V <sub>CC</sub> =1.7V, V <sub>o</sub> =-20.0dBv	
Input reduced noise voltage	V <sub>NIN</sub>	—	1.25	2.0	$\mu$ Vrms	R <sub>g</sub> =1.0k $\Omega$ , DIN-AUDIO Converted using NAB 1kHz gain	
Crosstalk between channels	CTc1	65	—	—	dB	D <sub>o</sub> =-20.0dBv, R <sub>g</sub> =1k $\Omega$	
Crosstalk between F/R	CTfr	68	—	—	dB	1kHz BPF+DIN-AUDIO	
AMS threshold	Mute - OFF	amsP	-69.5	-67.0	-64.5	dBv	Cams=2.2 $\mu$ F, Rams=0 $\Omega$ , TU-ON PRE OUT input value, V <sub>AMSOUT</sub> >0.3V
	Mute - ON	amsF	-62.5	-60.0	-57.5		
Ripple leak (Pre + R.F.)	RL1	—	—	-76	dBv	+B=1.0V+(-26dBv), f=130Hz V <sub>CC</sub> =2.0V+(-20dBv), f=130Hz I <sub>rf</sub> =-1.5mA 130Hz BPF+DIN-AUDIO	
Pre-muting attenuation	Mute1	75	—	—	dB	V <sub>CC</sub> =1.7V, R <sub>g</sub> =1k $\Omega$ , V <sub>o</sub> =-20dBv 1kHz BPF+DIN-AUDIO	
Metal-f characteristic	$\Delta$ GvM	-5.44	-4.54	-3.64	dB	Deviation at 10kHz, V <sub>o</sub> =-20dBv	

©Not designed for radiation resistance.

(unless otherwise noted, +B = 1.3V, V<sub>CC</sub> = 2.3V, f = 1kHz, PreOutR<sub>L</sub> = 5kΩ, PWROutR<sub>L</sub> = 16Ω (OCL), T<sub>a</sub> = 25°C, and measurement condition pertaining to ripple: V<sub>CC</sub> and +B are common-mode input)

Parameter	Symbol	Min.	Typ.	Max.	Unit	Coniditions
〈Power block〉						
Closed-loop voltage gain	G <sub>vc2</sub>	22.5	24.0	25.5	dB	V <sub>o</sub> = -20.0dBv
Interchannel balance	CB	-1.5	0.0	1.5		
Output power	P <sub>o</sub>	6.5	10.0	—	mW	+B=1.5V, THD=10%, R <sub>L</sub> =16Ω
Total harmonic distortion 1	THDp1	—	0.3	0.9	%	P <sub>o</sub> =1mW, 400~30kHz BPF
Total harmonic distortion 2	THDp2	—	0.4	1.0	%	P <sub>o</sub> =1mW, f=10kHz, 30kHz LPF
Output noise voltage	V <sub>NO</sub>	—	19.0	32.0	μV <sub>rms</sub>	R <sub>g</sub> =600Ω, DIN-AUDIO
Crosstalk	CT <sub>c2</sub>	28.0	—	—	dB	R <sub>g</sub> =3.3Ω, V <sub>o</sub> =-40dBv 1kHz BPF+DIN-AUDIO
Ripple leak	RL2	—	-92.5	-87.0	dBv	+B=1.0V+(-26dBv), f=130Hz V <sub>cc</sub> =2.0V+(-20dBv), f=130Hz R <sub>g</sub> =600Ω, 130HzBPF, I <sub>rf</sub> =-1.5mA
Muting attenuation	Mute2	80	—	—	dB	f=1kHz, V <sub>o</sub> =-20dBv B.B-MAX, 1kHz BPF+DIN-AUDIO
Input resistance	Z <sub>IN</sub>	25	30	35	kΩ	—
DC offset voltage	ΔV <sub>o</sub>	-25	0.0	15	mV	A/B-Amp in relation to C-Amp
〈Ripple filter〉						
Ripple rejection	RR	26.0	—	—	dB	V <sub>cc</sub> =2.0V+(-20dBv), f=130Hz 130Hz BPF+DIN-AUDIO, I <sub>rf</sub> =-1.5mA
DC output voltage	V <sub>r</sub>	1.42	1.50	—	V	V <sub>cc</sub> =1.7V, I <sub>rf</sub> =0mA
〈Boost〉						
Boost ON / OFF voltage gain deviation	ΔB.B	-2.0	0.0	1.0	dB	f=1kHz, V <sub>IN</sub> =-60dBv
Boost amount 1*	BG1	17.5	20.0	—	dB	f=50Hz, V <sub>IN</sub> =-60dBv, B.B-MAX
Boost amount 2**	BG2	3.7	5.2	6.7	dB	f=10kHz, V <sub>IN</sub> =-60dBv, B.B-MAX
Boost amount 3*	BG3	5.0	6.5	8.0	dB	f=50Hz, V <sub>IN</sub> =-60dBv, B.B-MID
Total harmonic distortion	THDB	—	0.3	1.0	%	f=1kHz, V <sub>IN</sub> =-40dBv, 30kHz LPF
Ripple leak	RLB	—	-82.5	-75.0	dBv	+B=1.0V+(-26dBv), f=130Hz V <sub>cc</sub> =2.0V+(-20dBv), f=130Hz R <sub>g</sub> =600Ω, 130Hz BPF+DIN-AUDIO

\* This is the amount of boost in relation to a gain of 1kHz, when the secondary LPF (low-pass filter) is attached as specified by the measurement circuit example.

\*\* This is the amount of boost in relation to a gain of 1kHz, when the HPF (high-pass filter) is attached as specified by the measurement circuit example.

(unless otherwise noted, +B = 1.3V, V<sub>CC</sub> = 2.3V, f = 1kHz, PreOutR<sub>L</sub> = 5k $\Omega$ (OCL), PWROutR<sub>L</sub> = 16 $\Omega$  (OCL), T<sub>a</sub> = 25°C)

Parameter	Symbol	Min.	Typ.	Max.	Unit	Coniditions
〈AVLS〉						
AVLS suppression level	AV <sub>o</sub>	-44.0	-41.0	-40.0	dBv	V <sub>IN</sub> = -30dBv R <sub>av</sub> = 6.8k $\Omega$ , R <sub>L</sub> = 16 $\Omega$
AVLS start input level	AV <sub>IN</sub>	-67.8	-64.8	-61.8	dBv	V <sub>IN</sub> = -64.8dBv R <sub>av</sub> = 6.8k $\Omega$ , R <sub>L</sub> = 16 $\Omega$
AVLS distortion	AVTHD	—	0.4	1.5	%	V <sub>IN</sub> = -20dBv, B.B-OFF R <sub>av</sub> = 6.8k $\Omega$ , R <sub>L</sub> = 16 $\Omega$
BEEP output level	VBEEP	-61	-58	-55	dBv	R <sub>L</sub> = 16 $\Omega$ , I <sub>BEEP</sub> = 5 $\mu$ A <sub>O-P</sub> f = 1kHz

Conditions applied to control pins

(Unless otherwise noted, +B = 0.9V, V<sub>cc</sub> = 1.7V, f = 1kHz, PreOutR<sub>L</sub> = 5kΩ, PWROutR<sub>L</sub> = 16Ω (OCL), Ta = 25°C)

Parameter	Symbol	Min.	Typ.	Max.	Unit	Coniditions	
<Pre block>							
Tuner / TC	Tuner	SW1	0.77	—	7.0	V	HIGH
	TC		−0.2	—	0.4	V	LOW / OPEN
	I <sub>SWIN</sub>		4	9	15	μA	V11pin=0.77V
FWD / REV	FWD	SW2	0.65	—	7.0	V	HIGH / OPEN
	REV		−0.2	—	0.2	V	LOW
	I <sub>SWOUT</sub>		0.5	2.3	3.5	μA	V13pin=0.2V
MTL / NOR	MTL	SW3	0.7	—	7.0	V	HIGH / OPEN
	NOR		−0.2	—	0.2	V	LOW
	I <sub>SWOUT</sub>		0.5	2.3	3.5	μA	V42pin=0.2V
<Power block>							
PWR ON / OFF	ON	SW4	0.77	—	7.0	V	HIGH
	OFF		−0.2	—	0.4	V	LOW / OPEN
	I <sub>SWIN</sub>		5	11	17	μA	V12pin=0.77V
MUTE ON / OFF	OFF	SW5	0.65	—	7.0	V	HIGH
	ON		−0.2	—	0.2	V	LOW
	I <sub>SWIN</sub>		—	0.25	1.0	μA	V10pin=0.65V
B.B ON / OFF	ON	SW6	0.75	—	7.0	V	HIGH
	OFF		−0.2	—	0.3	V	LOW
	I <sub>SWOUT</sub>		—	0.0	1.0	μA	V9pin=0.3V
	I <sub>SWIN1</sub>		—	0.0	1.0	μA	V9pin=1.5V, V10pin=0.6V
	I <sub>SWIN2</sub>		3	7	11	μA	V10pin=0V
AVLS ON / OFF	ON	SW7	—	—	—	V	PWR1 and PWR2 signals input
	OFF		−0.2	—	0.2	V	LOW
	I <sub>SWOUT</sub>		5	25	30	μA	V47pin=0.2V
B.B MAX / MID	MAX	SW8	0.65	—	7.0	V	HIGH / OPEN
	MID		−0.2	—	0.2	V	LOW
	I <sub>SWOUT</sub>		0.5	2.3	3.5	μA	V8pin=0.2V

I<sub>SWIN</sub> : Indicates current flowing to the interior of the IC.

I<sub>SWOUT</sub>: Indicates current flowing to the exterior of the IC.



●Electrical characteristic curves

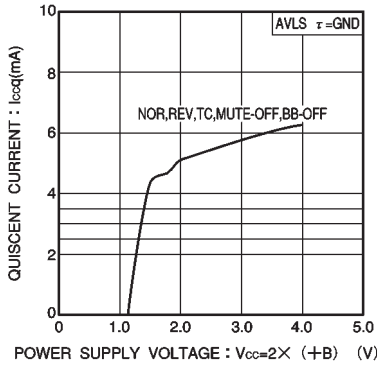

Fig.2 Quiescent current vs. power supply voltage

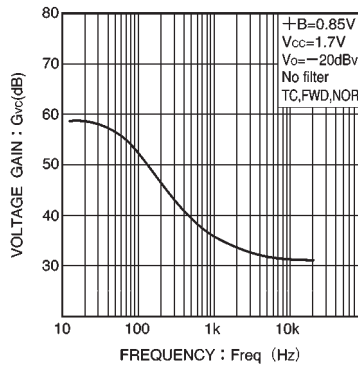

Fig.3 PRE gain vs. frequency

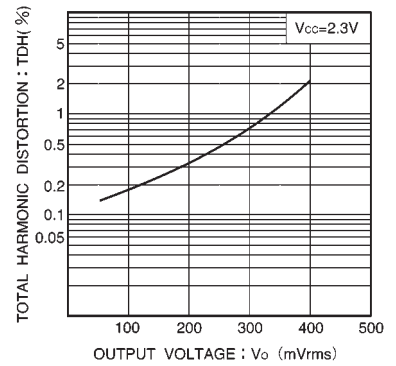

Fig.4 Total harmonic distortion

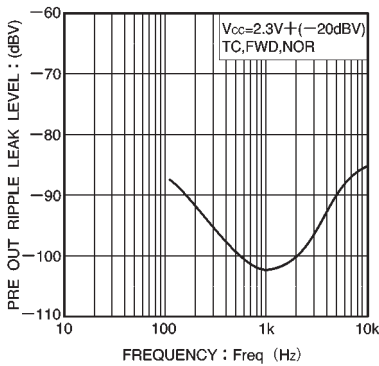

Fig.5 PRE ripple leak characteristics

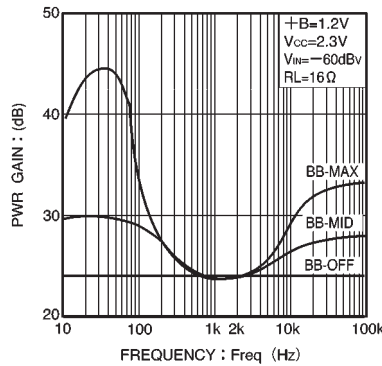

Fig.6 PWR gain vs. frequency

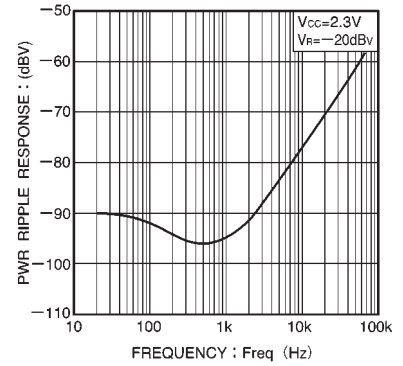

Fig.7 PWR ripple leak characteristics

●External dimensions (Units: mm)

