

# Powering the Pentium™ VRE with the Si9145 Voltage Mode Controlled PWM Converter

Chae K. Lee and Richard Williams

## Benefits

- First and only Intel-approved switching converter solution to provide static and dynamic voltage regulation for the Pentium VRE microprocessor.
- Low cost
- Efficiency greater than 89% at 7 A
- Eliminates the need for heat sinks
- Supplies maximum currents required by P54C
- High operating frequency (recommended 375 kHz) allows use of the smallest possible inductors and capacitors, resulting in lowest voltage ripple and best transient response
- Easily adjustable output voltage to meet the different specs of P54C family.
- PCB layout available
- Available in SO-16 surface-mount package

## A Proven Solution for the Pentium™ Converter

Siliconix has developed the first and only Intel- approved switching power supply solution for the Pentium VRE microprocessor. Built on a leading-edge CBiC/D process, the Si9145BY is the only voltage- mode controlled PWM IC capable of switching up to 2 MHz and providing a 25-MHz error amplifier. For the first time, a 100-kHz closed-loop bandwidth switching converter can be designed to meet the dynamic transient requirements of the Pentium microprocessor, without adding numerous output capacitors.

The Si9145BY consistently satisfies Pentium VRE voltage regulation limits within generous margins. Worst-case assumptions for voltage regulation, as provided by Intel, are displayed in Figure 2.

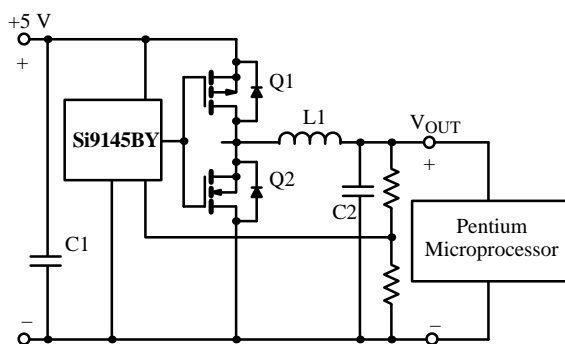

Figure 1. Typical Application Circuit

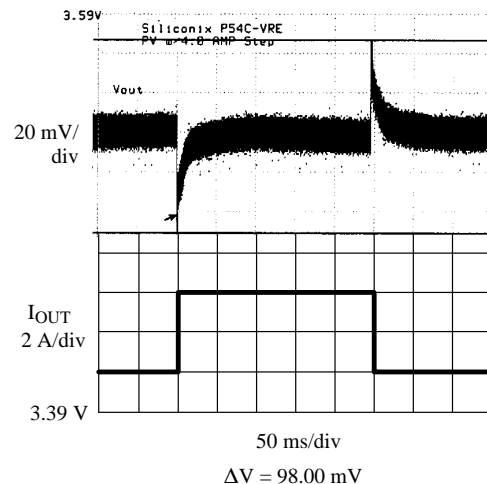

Figure 2. Intel Measured Transient Response

Pentium™ is a trademark of Intel Corporation.

## Regulation Requirements for the VRE Pentium Converter

The Pentium VRE microprocessor has been designed to operate faster and more efficiently than any of its predecessors. To save power, a CPU clock has been implemented with start/stop features, requiring an ultra-fast response from the power supply. To obtain higher clock speeds and to enhance manufacturing yields, the Pentium requires specific output voltage levels with tight voltage regulations (Figure 3). Within this stringent voltage regulation limit, no overshoot or undershoot are permitted to exceed the regulation limit, irrespective of their duration. Not surprisingly, these new demands have overwhelmed the capabilities of existing power supply designs based on conventional PWM ICs.

Meeting the tight static and transient regulation demands of the Pentium VRE microprocessor requires a certain amount of decoupling capacitance both at the processor

and at the output of the power supply. Obviously, the greater the decoupling capacitance, the easier it is to meet the transient regulation. Since cost and space limit the amount of capacitance one can use, Intel has recommended the use of six 100- $\mu$ F low-ESR tantalum capacitors and twenty-five 1- $\mu$ F ceramic capacitors.

The amount of output capacitance at the output of the converter also determines the transient response of a converter. The greater the output capacitance, the less converter bandwidth is required to meet the transient regulation. A 4-A transient response has been simulated using a SPICE program for various output capacitance characteristics (Table 1). A SPICE simulation with an 800- $\mu$ F output capacitor with 0.0125- $\Omega$  ESR reveals that converter with a 15- $\mu$ s response time will meet the voltage regulation limit of the Pentium VRE processor (Figure 4). This translates into a converter with approximately 32-kHz unity gain bandwidth, assuming a second-order response system with a damping coefficient of 0.9.

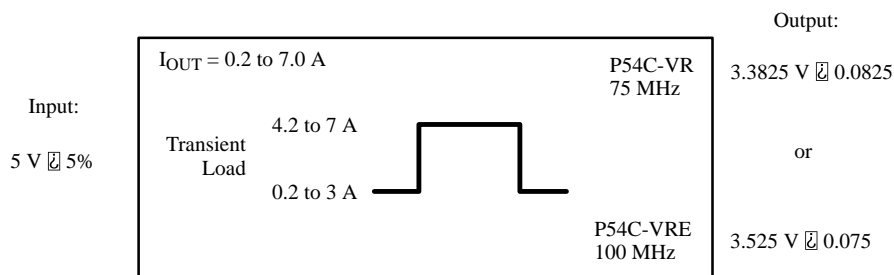
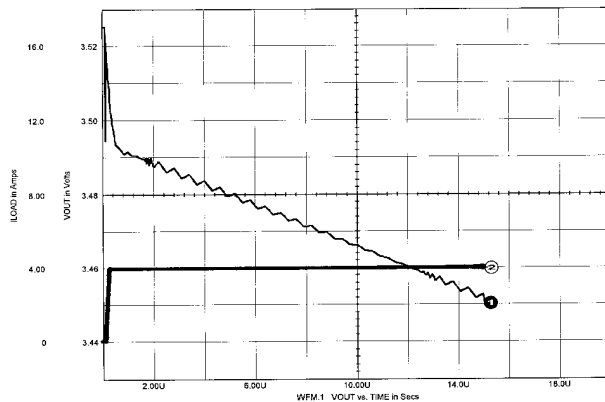

Figure 3. Pentium Converter Requirements

Output Capacitance ( $\mu$ F)	ESR	Response Time for $\pm 45$ -mV Regulation ( $\mu$ s)	BW for $\pm 45$ -mV Regulation (kHz)	Response Time for $\pm 75$ -mV Regulation ( $\mu$ s)	BW for $\pm 75$ -mV Regulation (kHz)
800	0.0125	5	95	15	32
700	0.0143	4	120	14	34
600	0.0167	3	160	13	37
500	0.020	2	240	12	40
400	0.025	1	480	11	43

Table 1. Transient Response



**Figure 4.** Transient Response

In reality, approximately 25% of the requisite regulation limit will be utilized by variations in the reference voltage and in the resistor dividers. To increase power supply manufacturing yields, it is also necessary to allow an additional tolerance in voltage regulation of 10% or more, further increasing the bandwidth requirement. If remote sensing is not available, delayed sensing of the processor voltage will cause a further drop.

Together, these constraints reduce the regulation limit of VRE Pentium converter from 75 mV to approximately 45 mV. To meet the 45-mV regulation limit requires a converter unity gain bandwidth of approximately 100 kHz. Obtaining a closed-loop bandwidth of 100 kHz requires a converter switching frequency of 375 kHz or greater. It also requires a ultra-fast error amplifier. Typically, the error amplifier must provide a bandwidth between 10 and 20 times the switching frequency to correctly respond to the stimuli. In the case of the Pentium converter, large bulk capacitors at the output of the converter and at the microprocessor require even greater bandwidth.

## The Linear Regulation Solution

In the past, linear regulators were the ideal solution for low-power, 5-V/3-V conversion. Linear regulators provided an inherently quiet power system, eliminating EMI/EMC problems. Stability and compensation issues were also minimal, making the application and analysis as simple as possible. The advantages of linear regulators remained significant until power demands increased. Under these new conditions, their disadvantages become obvious. With a 7-A output current, a VRE converter will dissipate over 10 W of power into an already blazing hot system, requiring cumbersome heat sinks. These increase

manufacturing difficulties and labor costs, which could easily offset the price advantage of the linear regulator solution. Meanwhile, the physical dimension requirements, 2.60 × 1.81 × 0.8 inches, could be easily exceeded with a large heat sink. Additionally, the cost savings of a linear regulator solution would be transferred to the increased costs of a larger, noisier fan required to circulate the additional heat over the circuit.

## Current Mode vs. Voltage Mode

The Pentium's exacting dynamic load requirements makes it crucial for the designers to choose an optimal control method to provide voltage regulation during the transients. There are two modes of control for a buck converter operating in fixed frequency: voltage mode or current mode. The transfer function of current mode control with the converter's loop gain from output to control voltage operating in continuous inductor current can be derived using the state space average model and stated below.

$$V_{oc} = \left( \frac{R_L}{R_{cs}} \right) \cdot \left( \frac{1}{1 + S \cdot C_o \cdot R_L} \right)$$

$R_L$  = load resistance

$R_{cs}$  = current sense resistance

$C_o$  = output capacitance

As the above equation shows, current mode control has inherently good input line regulation since the transfer function is unaffected by the input voltage. As the input voltage changes, the slope of the inductor current changes instantaneously in compensation. Unfortunately, loop gain is load dependent. As the output load varies from minimum to maximum, as in the case of the Pentium,  $R_L$  ranges from 0.5  $\Omega$  to 17.6  $\Omega$ , and the loop gain varies by approximately 31 dB. This could cause the power supply to oscillate, if the loop is not compensated correctly for all load conditions. Typically the power supply is compensated for the maximum load resistance and the design must somehow accommodate the loop bandwidth reduction during the minimum load resistance. With -1 slope, loop bandwidth can decrease by more than a 1.5 decades in frequency. This decrease in bandwidth could have catastrophic effects on the dynamic transient response of the Pentium.

Once its output voltage regulation is exceeded, performance could also be impaired. Violation of output voltage regulations could cause the processor to exhibit failure characteristics ranging from an obvious, flagged software/hardware error to insidious, subtle, and unpredictable computational errors.

Current mode can also decrease noise immunity if the slope of the inductor current is too small to increase efficiency. By having the ramp voltage always close to the error voltage, a small noise injection into the current ramp could cause a large variation in the duty cycle.

Current mode also requires a slope compensation for duty cycles greater than 50%, adding parts and cost. For 5-V to 3.525-V conversion, the duty cycle exceeds 70% without counting FET and parasitic losses.

The transfer function for the voltage-mode control buck converter is stated below.

$$V_{OC} = \left( \frac{V_{IN}}{V_s} \right) \cdot \left( \frac{1}{1 + S \cdot \frac{L}{R_L} + S^2 \cdot L \cdot C_o} \right)$$

$V_{IN}$  = input voltage

$V_s$  = ramp voltage

$L$  = inductance

In the voltage mode control converter, loop gain is a function of input voltage instead of load resistance. Load resistance affects the Q-ing of the converter. Since the input voltage of the Pentium converter is virtually fixed, loop gain is considered constant. Input voltage for the Pentium varies from 4.75 V to 5.25 V, less than 1 dB variation. With the loop gain constant, the converter's bandwidth can be maximized and that same wide bandwidth can be maintained, irrespective of load changes. Therefore, the voltage-mode controlled converter is an ideal control method for the Pentium converter. With virtually fixed input voltages and a wide load variation, bandwidth can be maximized and transient response times minimized.

Voltage-mode control does have a minor disadvantage. As revealed in the above equation, its double-pole filter is generally more complicated to compensate than the single-pole filter of current-mode control. This means the addition of a pole-zero pair compensation network. Siliconix' application circuit solves this problem with optimal compensation values.

## Transient Response

Maintaining the output voltage regulation within the  $\pm 45$ -mV during the 4-A transient is not a trivial task for any power supply designer. Present solutions advertised by other PWM manufacturers using current-mode control lack bandwidth or dc gain to satisfy the voltage regulation of the VRE Pentium microprocessor. Without a voltage-mode PWM IC capable of switching at 375 kHz or above, designers have been forced to use current-mode controllers with much lower switching frequencies. Operating at a lower switching frequency generally yields slightly greater efficiency, but the disadvantages far outweigh the efficiency tradeoff. A lower operating frequency forces the designers to use much larger inductance and capacitance to maintain the same ripple voltage compared to the higher frequency operation, increasing space and cost. This increase in inductance also has a detrimental effect during the dynamic load transients. During the transition from maximum to minimum load, energy stored in the inductor makes a forced discharge into the output capacitance. Therefore, the larger the inductance, the more energy is stored in the inductor, causing a larger overshoot on the output voltage during the unloading transition. During the minimum-to-maximum current transition, a larger inductor delays the ramping of current demanded by the load, further sagging the output voltage.

The advantages of the Si9145BY, with its higher switching frequency and wide bandwidth error amplifier, are clearly demonstrated by comparing the two converters outlined in Table 2. A complete VRE-specified converter schematic operating at 375 kHz is shown in Figure 5.

	Converter #1	Converter #2
Switching Frequency	375 kHz	125 kHz
Closed Loop BW	100 kHz	33 kHz
Output Capacitance	800 $\mu$ F	2400 $\mu$ F
Inductance	2.4 $\mu$ H	7.2 $\mu$ H

**Table 2.** Converter Response Comparison

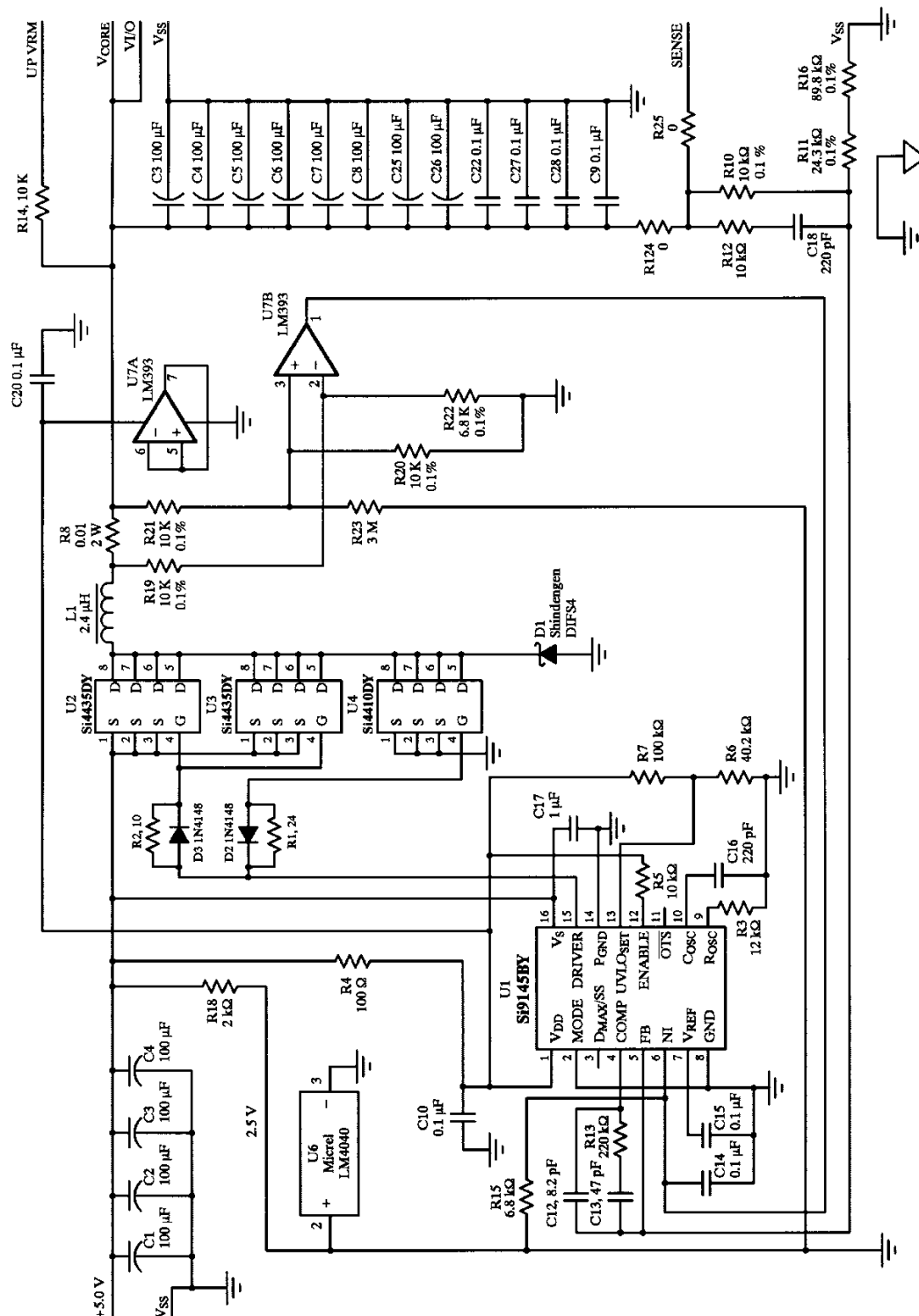

NOTE:

1. R24 and R25 are designed in the circuit to provide the flexibility to remote sense. Remove R24 if remote sensing is utilized. Remove R25 if remote sensing is not utilized.
2. Remove R17 to float the PWRGOOD signal. The new version of the Intel specification requires the PWRGOOD signal to be an open-collector output or floating.

Figure 5. Pentium Converter

## Pin Description

Pin	Description
1A	V <sub>SS</sub>
1B	V <sub>SS</sub>
2A	V <sub>SS</sub>
2B	V <sub>SS</sub>
3A	ND
3B	VI/O
4A	VI/O
4B	VI/O
5A	+3.3 V
5B	+3.3 V
6A	+3.3 V
6B	+3.3 V
7A	V <sub>CORE</sub>
7B	V <sub>CORE</sub>
8A	V <sub>CORE</sub>
8B	V <sub>CORE</sub>
9A	V <sub>SS</sub>
9B	V <sub>CORE</sub>
10A	V <sub>CORE</sub>
10B	V <sub>CORE</sub>
11A	PWRGOOD
11B	UPVRM#
12A	SENSE
12B	DISABLE
13A	V <sub>SS</sub>
13B	V <sub>SS</sub>
14A	+5.0 V
15B	+5.0 V
15A	+5.0 V
15B	+5.0 V
CONN2XL15_ALPHA	

Figures 6 and 7 show the dynamic response to 4-A transients. Notice that the settling time of the 375-kHz converter is three times faster than that of the 125-kHz converter. The magnitude of regulation was identical for both converters. Note, however, that the 125-kHz converter's output capacitor and inductor size and value were increased by factor of three to maintain the consistency shown in Table 2. The +45-mV transient regulation result reaffirms the need for a converter bandwidth of 100 kHz or more to meet the regulation needs of the Pentium VRE processor.

## Synchronous Rectification

A continuous inductor current mode is necessary to sustain the converter's large bandwidth, irrespective of control method (voltage or current). If the mode of operation changes from continuous to discontinuous inductor current mode, the transfer function of the converter will change drastically. This is precisely why synchronous rectification should be utilized.

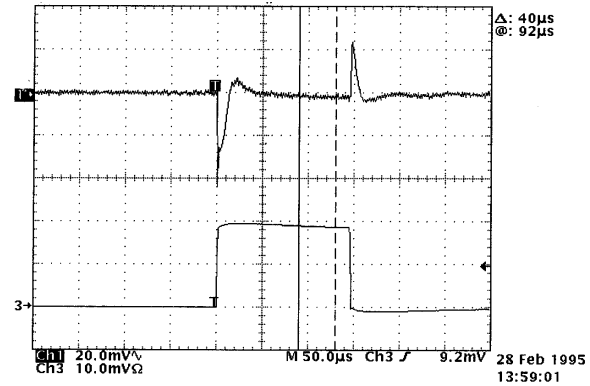

Figure 6. 100-kHz BW Transient Response

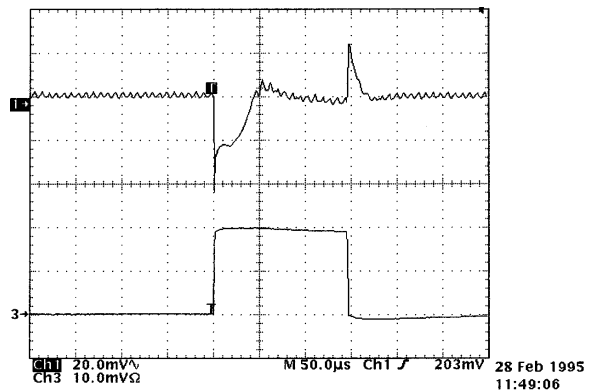

Figure 7. 33-kHz BW Transient Response

Synchronous rectification ensures continuous inductor current, regardless of output current. By maintaining continuous inductor current, the transfer function remains constant, preserving its large bandwidth. Figure 8 shows the bode plot of a non-synchronous converter. Notice the drastic decrease in the loop bandwidth from 100 kHz to 4.2 kHz as a result of the transformation into discontinuous mode.

Synchronous rectification also buys greater efficiency compared with using a Schottky diode as the rectifier, particularly when used in conjunction with

low-on-resistance power MOSFETs built on an innovative Trench technology.

For example, the Si4410DY Trench MOSFET from Siliconix offers an  $r_{DS(on)}$  of  $0.02 \Omega$  at  $V_{GS} = 4.5 \text{ V}$ . At a 7-A output current, the MOSFET drops only 0.14 V, compared with a typical voltage drop of 0.60 V across the

Schottky diode. Efficiency can be increased considerably, since the synchronous rectifier conducts for approximately 30% of the period. Figure 9 shows the efficiency of the Pentium converter using two p-channel Si4435DYs as the high-side switch and one n-channel Si4410DY as the low-side switch.

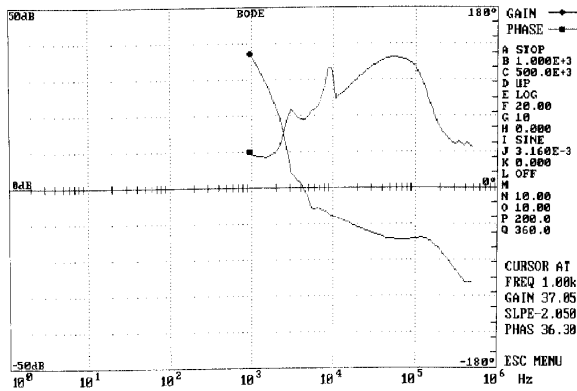

Figure 8. Non-Synchronous Bode Plot

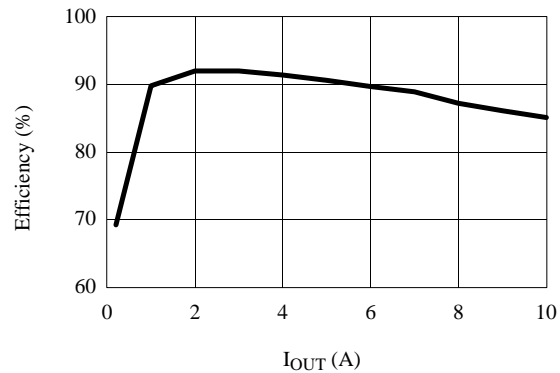

Figure 9. Efficiency Curve

## Component Supplier List

Reference Designator	Part Number	Description	Pattern	Vendor	Phone #
C1-C8, C23-C26	TPSD107K010R	Tantalum Capacitor 100 $\mu\text{F}$ , 10 V	D	AVX	(803) 448-9411
D1	DIFS4	1.1 A, 40 V	IF	Shindengen	(800) 543-6525
L1	CTX07-12717-1	2.4 $\mu\text{H}$ , 7 A		Coiltronics	(407) 241-7876
P1	66527-015	15 $\times$ 2		Berg Electronics	(800) 237-2374
R8	SL-2	0.01 $\Omega$ , 2 W		KRL	(603) 668-3210
U1	Si9145BY	PWM IC	SO-16	Siliconix	(800) 554-5565
U2, U3	Si4435DY	P-Ch MOSFET	SO-8	Siliconix	(800) 554-5565
U4	Si4410DY	N-Ch MOSFET	SO-8	Siliconix	(800) 554-5565
U6	LM4040BIM	Reference	SOT-23	National	(408) 721-5000
U7	LM393M	Comparator	SO-8	National	(408) 721-5000

**Bill of Material for Pentium Converter**

Part	Used	Part Type	Designators	Footprint Pattern
1	2	0	R24 R25	0805
2	1	0.01, 2 W	R8	9433 2W
3	10	0.1 $\mu$ F	C9 C10 C11 C14 C15 C19 C20 C22 C27 C28	0805
4	2	1N4148	D2 D3	MLL34
5	1	1 $\mu$ F	C17	1825
6	1	2.4 $\mu$ H	L1	INDUCTOR
7	1	2K	R18	0805
8	1	3M	R23	1206
9	1	6.8K	R15	0805
10	1	6.8K	R22	1206
11	1	8.2 pF	C12	0805
12	1	10	R2	0805
13	4	10K	R5 R12 R14 R17	0805
14	4	10K, 0.1%	R10 R19 R20 R21	1206
15	1	12K	R3	1206
16	1	24	R1	0805
17	1	24.3K, 0.1%	R11	1206
18	1	40.2K	R6	0805
19	1	47 pF	C13	0805
20	1	89.8	R16	1206
21	1	100	R4	0805
22	1	100K	R7	0805
23	12	100 $\mu$ F	C1 C2 C3 C4 C5 C6 C7 C8 C23 C24 C25 C26	7374
24	1	220K	R13	0805
25	2	220 pF	C16 C18	0805
26	1	CONN2X15 ALPHA	P1	CONN VRM
27	1	LM393M	U7	SO-8
28	1	MICREL LM4040BIM	U6	SOT-23-5
29	1	DIFS4	D1	6032
30	1	Si4410DY	U4	SO-8
31	2	Si4435DY	U2 U3	SO-8
32	1	Si9145BY	U1	SO-16