

SANYO	No.2297A	2 S C 3 7 8 4
	NPN Epitaxial Planar Type Silicon Transistor	
DRIVER APPLICATIONS		

Applications

- . Suitable for use in switching of L load (motor drivers, printer hammer drivers, relay drivers)

Features

- . High DC current gain
- . Wide ASO
- . On-chip zener diode of $60 \pm 10V$ between collector and base
- . Uniformity in collector to base breakdown voltage
- . Large inductive load handling capability

Absolute Maximum Ratings at $T_a=25^\circ C$

			unit
Collector to Base Voltage	V_{CBO}	#50	V
Collector to Emitter Voltage	V_{CEO}	#50	V
Emitter to Base Voltage	V_{EBO}	6	V
Collector Current	I_C	1.2	A
Peak Collector Current	i_{cp}	2.5	A
Collector Dissipation	P_C	1.2	W
	P_C	$T_c=25^\circ C$	20 W
Junction Temperature	T_j	150	$^\circ C$
Storage Temperature	T_{stg}	-55 to +150	$^\circ C$

*: On-chip zener diode ($60 \pm 10V$)

Electrical Characteristics at $T_a=25^\circ C$

			min	typ	max	unit
Collector Cutoff Current	I_{CBO}	$V_{CB}=40V, I_E=0$			10	uA
Emitter Cutoff Current	I_{EBO}	$V_{EB}=5V, I_C=0$			10	mA
DC Current Gain	h_{FE}	$V_{CE}=5V, I_C=500mA$	1000	4000		
Gain-Bandwidth Product	f_T	$V_{CE}=5V, I_C=500mA$		180		MHz
C-E Saturation Voltage	$V_{CE(sat)}$	$I_C=500mA, I_B=2mA$		1.0	1.5	V
B-E Saturation Voltage	$V_{BE(sat)}$	$I_C=500mA, I_B=2mA$			2.0	V
Inductive Load Handling Capability	E s/b	$L=100mH, R_{BE}=100ohms$	15			mJ
C-B Breakdown Voltage	$V_{(BR)CBO}$	$I_C=100uA, I_E=0$	50	60	70	V
C-E Breakdown Voltage	$V_{(BR)CEO}$	$I_C=1mA, R_{BE}=\infty$	50	60	70	V

Continued on next page.

Package Dimensions 2043A
(unit: mm)

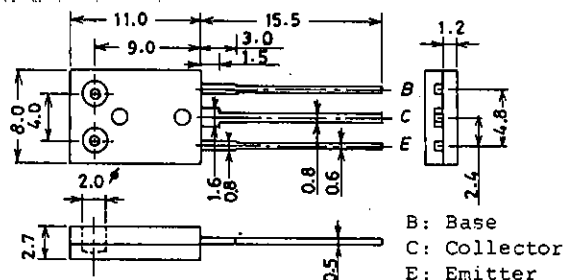

Continued from preceding page.

			min	typ	max	unit
Turn-on Time	t_{on}	See specified Test Circuit.		0.2		us
Storage Time	t_{stg}			2.2		us
Fall Time	t_f			0.4		us

Switching Time Test Circuit

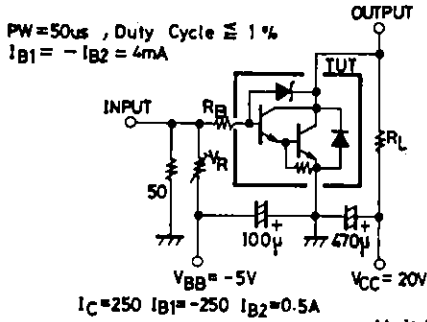

Es/b Test Circuit

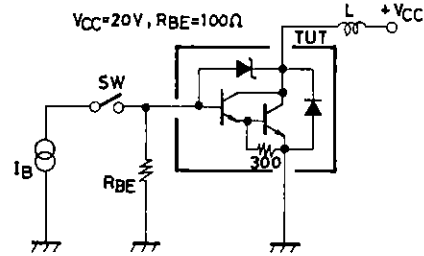

Unit (resistance: Ω , capacitance: F)

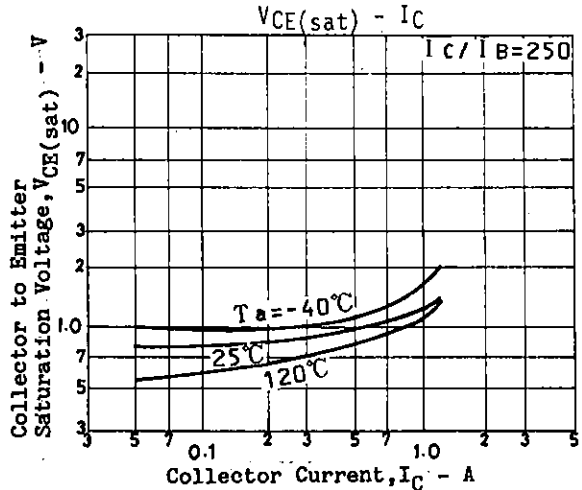
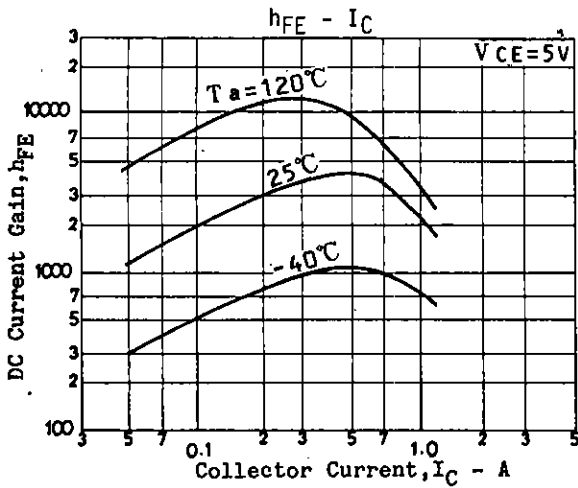
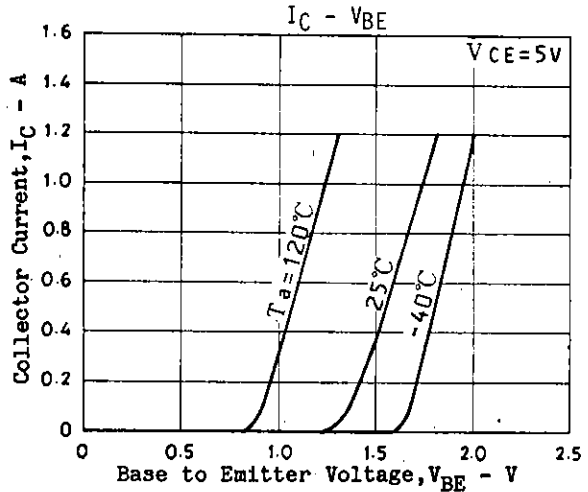
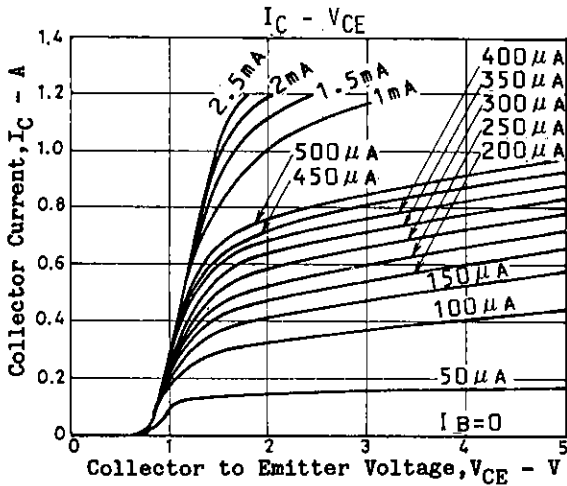

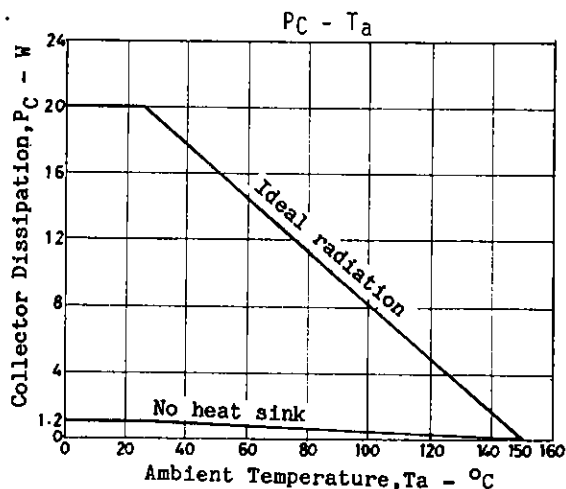
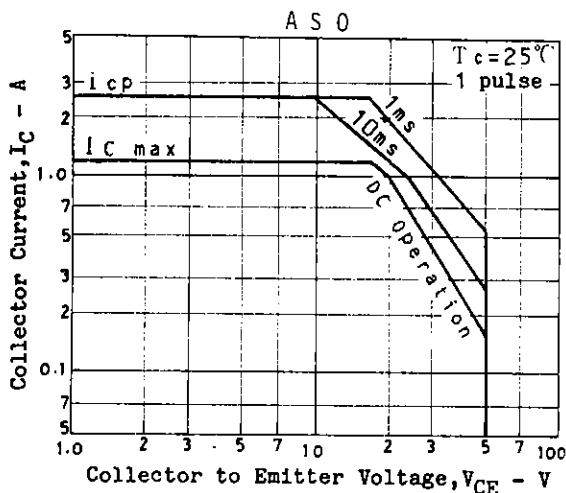
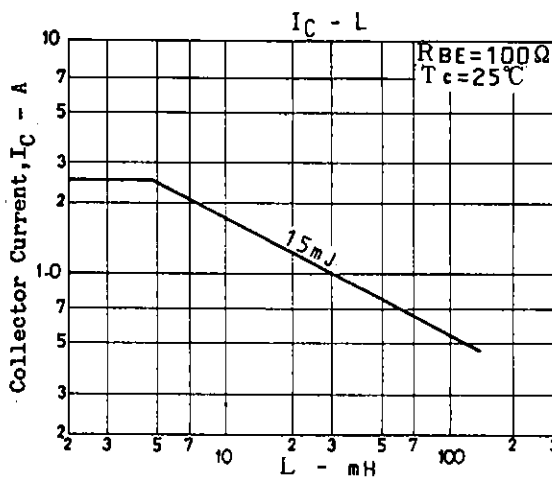
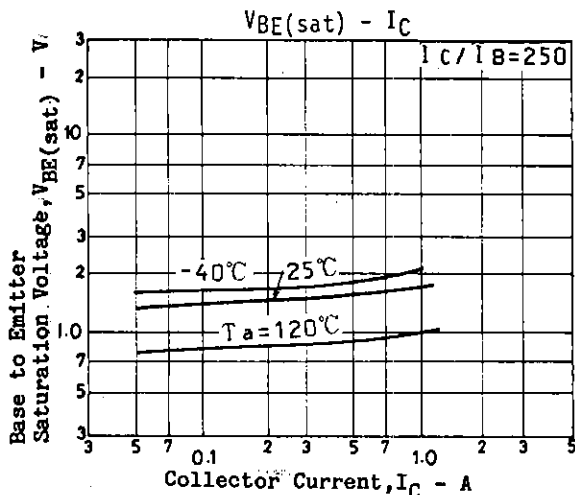

- No products described or contained herein are intended for use in surgical implants, life-support systems, aerospace equipment, nuclear power control systems, vehicles, disaster/crime-prevention equipment and the like, the failure of which may directly or indirectly cause injury, death or property loss.
- Anyone purchasing any products described or contained herein for an above-mentioned use shall:
 - ① Accept full responsibility and indemnify and defend SANYO ELECTRIC CO., LTD., its affiliates, subsidiaries and distributors and all their officers and employees, jointly and severally, against any and all claims and litigation and all damages, cost and expenses associated with such use;
 - ② Not impose any responsibility for any fault or negligence which may be cited in any such claim or litigation on SANYO ELECTRIC CO., LTD., its affiliates, subsidiaries and distributors or any of their officers and employees jointly or severally.
- Information (including circuit diagrams and circuit parameters) herein is for example only; it is not guaranteed for volume production. SANYO believes information herein is accurate and reliable, but no guarantees are made or implied regarding its use or any infringements of intellectual property rights or other rights of third parties.