

REVISION HISTORY			REVISION APPROVAL			
REV	ECO	DESCRIPTION	PROJECT ENGINEER	APPROVAL DATE	DOCUMENT CONTROL	APPROVAL DATE
A	E11244	INITIAL RELEASE A/W @ REV-A				

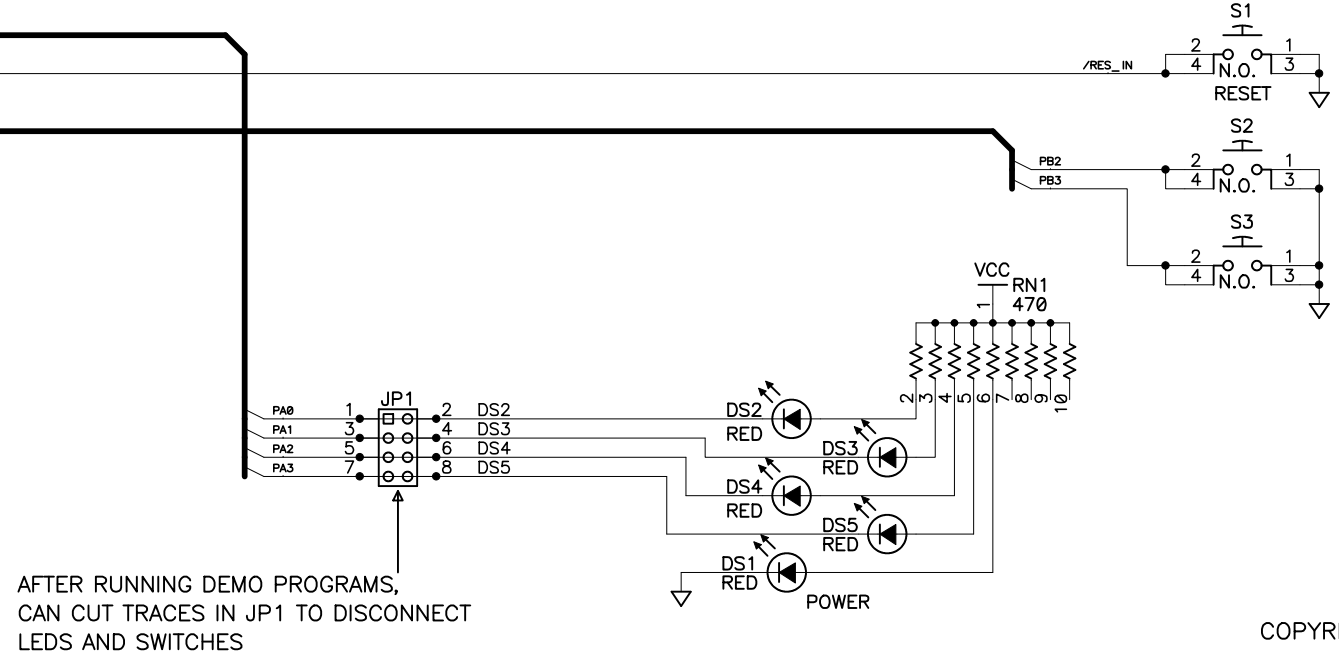
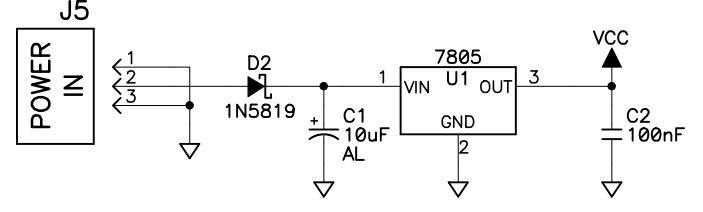
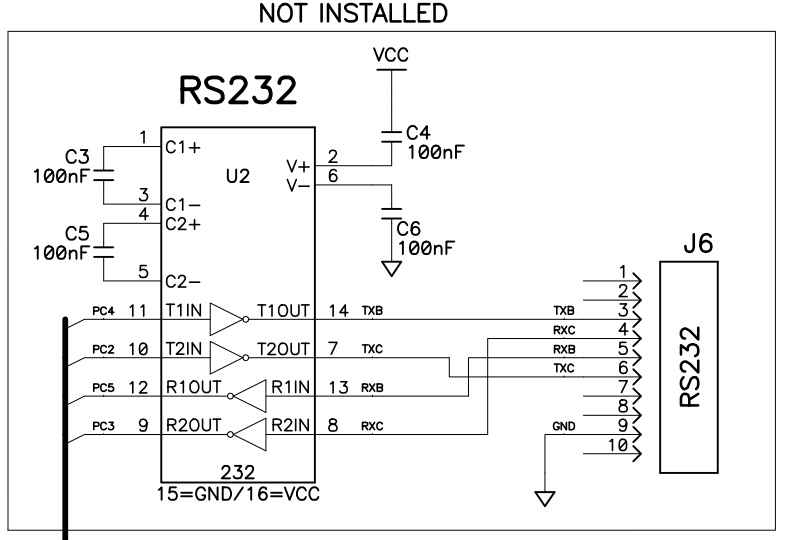

AFTER RUNNING DEMO PROGRAMS,
CAN CUT TRACES IN JP1 TO DISCONNECT
LEDS AND SWITCHES

COPYRIGHT 2000, Z-WORLD, INC.

APPEND THE FOLLOWING DOCUMENTS WHEN CHANGING THIS DOCUMENT:		DRAWING CONTENT:		TITLE	
		DRAWN BY: (INITIAL RELEASE)	200CT00	SCHEMATIC DIAGRAM	
		KAH		ETHERNET CORE	
		REVISED BY:	220CT00	MODULE PROTOTYPING	
		KAH		BOARD	
APPROVALS: INITIAL RELEASE				Z-WORLD	
PROJECT ENGINEER:				2900 SPAFFORD ST.	
ENGINEERING MANAGER:				DAVIS, CA 95616	
				530 - 757 - 4616	
SIGNATURES		DATE		SIZE	DWG NO.
				B	090-0116
				SCALE	RELEASE DATE
				NONE	
				SHEET 1 OF 2	

SURFACE MOUNT PROTOTYPING PADS

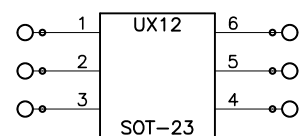
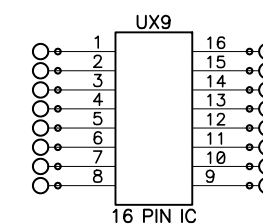
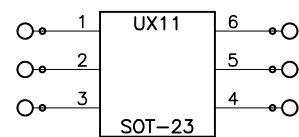
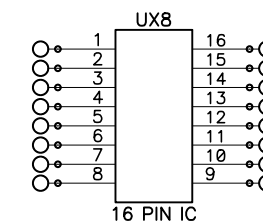
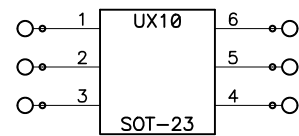
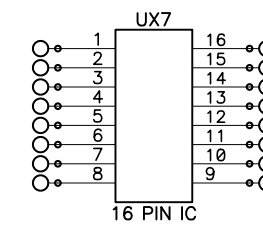
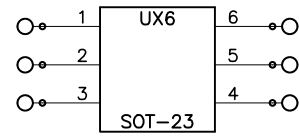
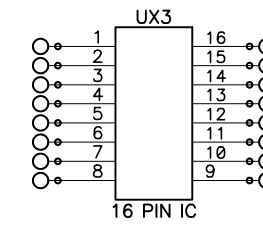
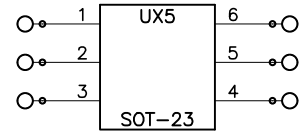
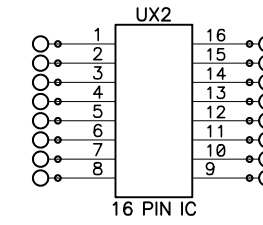
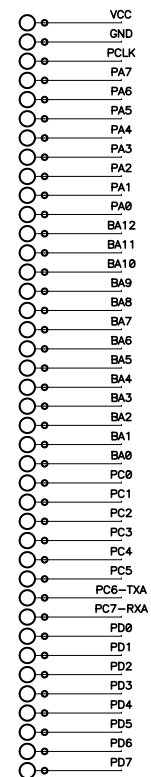
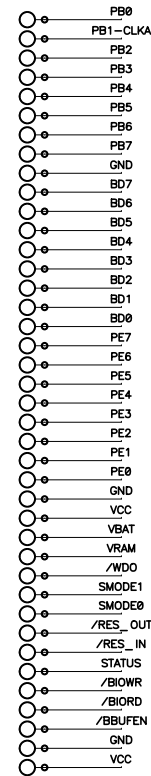
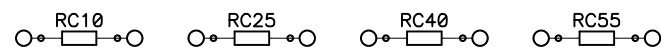
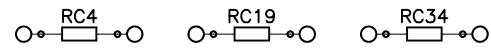
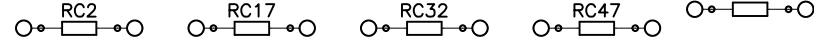
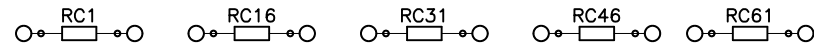
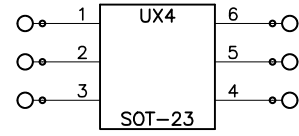
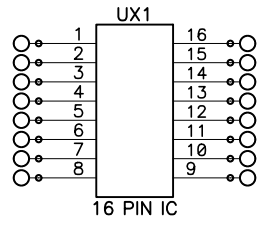

COPYRIGHT 2000, Z-WORLD, INC.

SIZE B	DWG NO. 090-0116
SCALE NONE	REV LTR A
SHEET 2 OF 2	