

Test & Measurement

Application Note 95-1

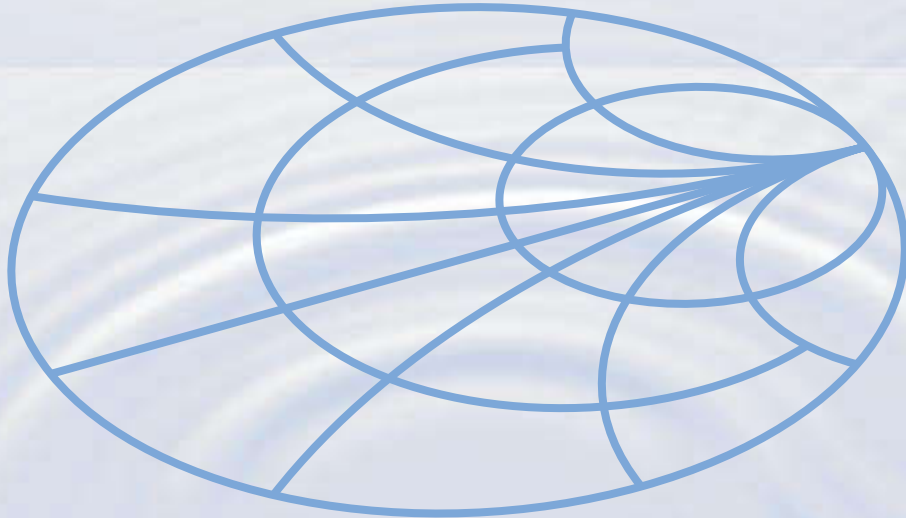

# S-Parameter Techniques

for Faster, More Accurate Network Design

<http://www.hp.com/go/tmappnotes>

# Contents

1. [Foreword and Introduction](#)
  2. [Two-Port Network Theory](#)
  3. [Using S-Parameters](#)
  4. [Network Calculations with Scattering Parameters](#)
  5. [Amplifier Design using Scattering Parameters](#)
  6. [Measurement of S-Parameters](#)
  7. [Narrow-Band Amplifier Design](#)
  8. [Broadband Amplifier Design](#)
  9. [Stability Considerations and the Design of Reflection Amplifiers and Oscillators](#)
- Appendix A.** [Additional Reading on S-Parameters](#)
- Appendix B.** [Scattering Parameter Relationships](#)
- Appendix C.** [The Software Revolution](#)
- [Relevant Products, Education and Information](#)
- [Contacting Hewlett-Packard](#)

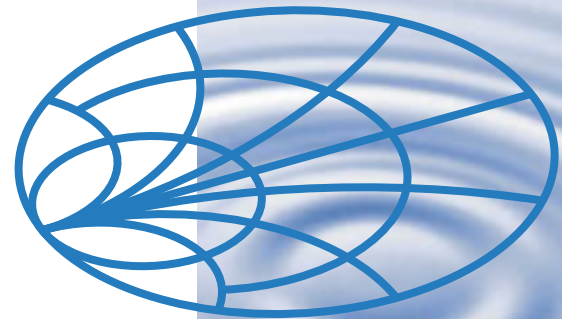

# Foreword

This application note is based on an article written for the February 1967 issue of the *Hewlett-Packard Journal*, yet its content remains important today. S-parameters are an essential part of high-frequency design, though much else has changed during the past 30 years. During that time, HP has continuously forged ahead to help create today's leading test and measurement environment.

We continuously apply our capabilities in measurement, communication, and computation to produce innovations that help you to improve your business results. In wireless communications, for example, we estimate that 85 percent of the world's GSM (Groupe Speciale Mobile) telephones are tested with HP instruments. Our accomplishments 30 years hence may exceed our boldest conjectures.

This interactive application note revises and updates the 1967 article for online electronic media. It reflects the changes in our industry, while reminding us of the underlying scientific basis for the technology, and takes advantage of a potent new information dissemination capability, the World Wide Web. We hope you find this tutorial useful.

Richard Anderson,  
HP Vice President and General Manager,  
Microwave and Communications Group

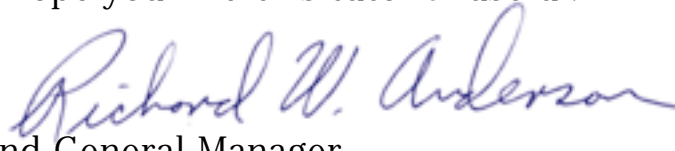

## HEWLETT-PACKARD JOURNAL

Cover: A NEW MICROWAVE INSTRUMENT SWEEP  
MEASURES GAIN, PHASE IMPEDANCE  
WITH SCOPE OR METER READOUT; page 2  
See Also: THE MICROWAVE ANALYZER IN THE  
FUTURE; page 11  
S-PARAMETERS THEORY AND  
APPLICATIONS; page 13

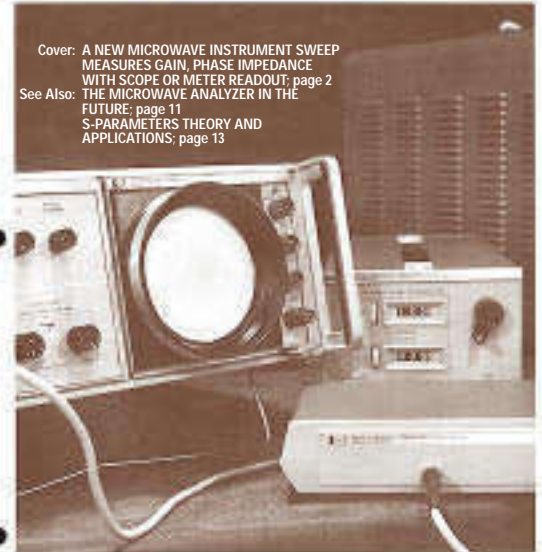

FEBRUARY 1967

**February 1967 HP Journal**  
Cover of issue in which  
the original "S-Parameters  
Theory and Application,"  
written during Christmas  
holiday 1966, first appeared.  
HP Journal is now online at:  
[www.hp.com/go/journal](http://www.hp.com/go/journal)

# 1 Introduction

Linear networks, or nonlinear networks operating with signals sufficiently small to cause the networks to respond in a linear manner, can be completely characterized by parameters measured at the network terminals (ports) without regard to the contents of the networks. Once the parameters of a network have been determined, its behavior in any external environment can be predicted, again without regard to the contents of the network.

S-parameters are important in microwave design because they are easier to measure and work with at high frequencies than other kinds of parameters. They are conceptually simple, analytically convenient, and capable of providing a great insight into a measurement or design problem.

To show how s-parameters ease microwave design, and how you can best take advantage of their abilities, this application note describes s-parameters and flow graphs, and relates them to more familiar concepts such as transducer power gain and voltage gain. Data obtained with a network analyzer is used to illustrate amplifier design.

## Maxwell's equations

All electromagnetic behaviors can ultimately be explained by Maxwell's four basic equations:

$$\begin{aligned}\nabla \cdot \mathbf{D} &= \rho & \nabla \times \mathbf{E} &= -\frac{\partial \mathbf{B}}{\partial t} \\ \nabla \cdot \mathbf{B} &= 0 & \nabla \times \mathbf{H} &= \mathbf{j} + \frac{\partial \mathbf{D}}{\partial t}\end{aligned}$$

However, it isn't always possible or convenient to use these equations directly. Solving them can be quite difficult. Efficient design requires the use of approximations such as lumped and distributed models.

# 2 Two-Port Network Theory

Although a network may have any number of ports, network parameters can be explained most easily by considering a network with only two ports, an input port and an output port, like the network shown in Figure 1. To characterize the performance of such a network, any of several parameter sets can be used, each of which has certain advantages. Each parameter set is related to a set of four variables associated with the two-port model. Two of these variables represent the excitation of the network (independent variables), and the remaining two represent the response of the network to the excitation (dependent variables). If the network of Fig. 1 is excited by voltage sources  $V_1$  and  $V_2$ , the network currents  $I_1$  and  $I_2$  will be related by the following equations (assuming the network behaves linearly):

$$I_1 = y_{11} V_1 + y_{12} V_2 \quad (1)$$

$$I_2 = y_{21} V_1 + y_{22} V_2 \quad (2)$$

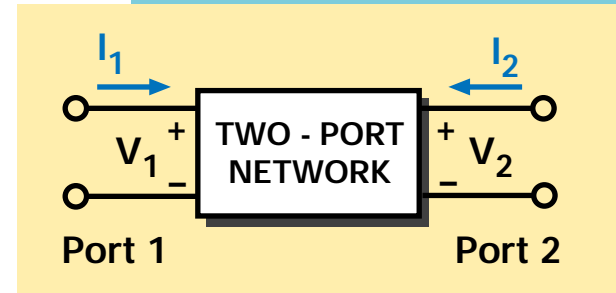
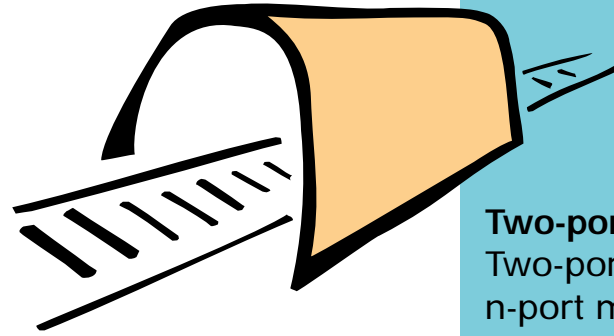

**Figure 1**  
General two-port network.

**Why are models needed?**  
Models help us predict the behavior of components, circuits, and systems. Lumped models are useful at lower frequencies, where some physical effects can be ignored because they are so small. Distributed models are needed at RF frequencies and higher to account for the increased behavioral impact of those physical effects.

# 2 Two-Port Network Theory

In this case, with port voltages selected as independent variables and port currents taken as dependent variables, the relating parameters are called short-circuit admittance parameters, or y-parameters. In the absence of additional information, four measurements are required to determine the four parameters  $y_{11}$ ,  $y_{12}$ ,  $y_{21}$ ,  $y_{22}$ . Each measurement is made with one port of the network excited by a voltage source while the other port is short circuited. For example,  $y_{21}$ , the forward transadmittance, is the ratio of the current at port 2 to the voltage at port 1 with port 2 short circuited, as shown in equation 3.



## Two-port models

Two-port, three-port, and n-port models simplify the input / output response of active and passive devices and circuits into “black boxes” described by a set of four linear parameters. Lumped models use representations such as Y (conductances), Z (resistances), and h (a mixture of conductances and resistances). Distributed models use s-parameters (transmission and reflection coefficients).

$$y_{21} = \frac{I_2}{V_1} \Big|_{V_2=0} \text{ (output short circuited)} \quad (3)$$

# 2 Two-Port Network Theory

If other independent and dependent variables had been chosen, the network would have been described, as before, by two linear equations similar to equations 1 and 2, except that the variables and the parameters describing their relationships would be different. However, all parameter sets contain the same information about a network, and it is always possible to calculate any set in terms of any other set.

“Scattering parameters,” which are commonly referred to as s-parameters, are a parameter set that relates to the traveling waves that are scattered or reflected when an n-port network is inserted into a transmission line.

[Appendix B “Scattering Parameter Relationships”](#) contains tables converting scattering parameters to and from [conductance parameters](#) (y), [resistance parameters](#) (z), and a mixture of [conductances and resistances parameters](#) (h).

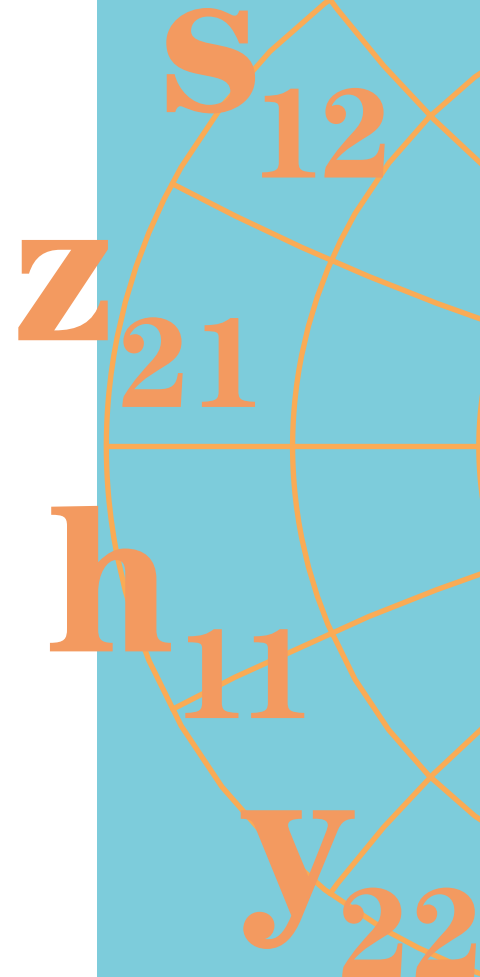

# 3 Using S-Parameters

The ease with which scattering parameters can be measured makes them especially well suited for describing transistors and other active devices. Measuring most other parameters calls for the input and output of the device to be successively opened and short circuited. This can be hard to do, especially at RF frequencies where lead inductance and capacitance make short and open circuits difficult to obtain. At higher frequencies these measurements typically require tuning stubs, separately adjusted at each measurement frequency, to reflect short or open circuit conditions to the device terminals. Not only is this inconvenient and tedious, but a tuning stub shunting the input or output may cause a transistor to oscillate, making the measurement invalid.

50  $\Omega$   
load and source

S-parameters, on the other hand, are usually measured with the device imbedded between a 50  $\Omega$  load and source, and there is very little chance for oscillations to occur.



# 3 Using S-Parameters

Another important advantage of s-parameters stems from the fact that traveling waves, unlike terminal voltages and currents, do not vary in magnitude at points along a lossless transmission line. This means that scattering parameters can be measured on a device located at some distance from the measurement transducers, provided that the measuring device and the transducers are connected by low-loss transmission lines.

## Derivation

Generalized scattering parameters have been defined by [K. Kurokawa \[Appendix A\]](#). These parameters describe the interrelationships of a new set of variables ( $a_i$ ,  $b_i$ ). The variables  $a_i$  and  $b_i$  are normalized complex voltage waves incident on and reflected from the  $i^{\text{th}}$  port of the network. They are defined in terms of the terminal voltage  $V_i$ , the terminal current  $I_i$ , and an arbitrary reference impedance  $Z_i$ , where the asterisk denotes the complex conjugate:

$$a_i = \frac{V_i + Z_i I_i}{2\sqrt{|\operatorname{Re} Z_i|}} \quad (4)$$

$$b_i = \frac{V_i - Z_i^* I_i}{2\sqrt{|\operatorname{Re} Z_i|}} \quad (5)$$



### Transmission and Reflection

When light interacts with a lens, as in this photograph, part of the light incident on the woman's eyeglasses is reflected while the rest is transmitted. The amounts reflected and transmitted are characterized by optical reflection and transmission coefficients. Similarly, scattering parameters are measures of reflection and transmission of voltage waves through a two-port electrical network.

# 3 Using S-Parameters

For most measurements and calculations it is convenient to assume that the reference impedance  $Z_i$  is positive and real. For the remainder of this article, then, all variables and parameters will be referenced to a single positive real impedance,  $Z_0$ .

The wave functions used to define s-parameters for a two-port network are shown in Fig. 2.

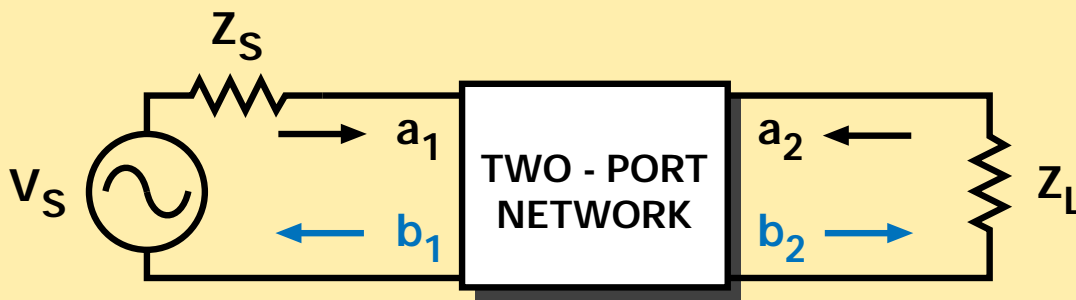

**Figure 2**

Two-port network showing incident waves ( $a_1$ ,  $a_2$ ) and reflected waves ( $b_1$ ,  $b_2$ ) used in s-parameter definitions. The flow graph for this network appears in [Figure 3](#).

**Scattering parameters relationship to optics**  
Impedance mismatches between successive elements in an RF circuit relate closely to optics, where there are successive differences in the index of refraction. A material's characteristic impedance,  $Z_0$ , is inversely related to the index of refraction,  $N$ :

$$Z_0 \sqrt{\frac{\epsilon}{377}} = \frac{1}{N}$$

The s-parameters  $s_{11}$  and  $s_{22}$  are the same as optical reflection coefficients;  $s_{12}$  and  $s_{21}$  are the same as optical transmission coefficients.

# 3 Using S-Parameters

The independent variables  $a_1$  and  $a_2$  are normalized incident voltages, as follows:

$$a_1 = \frac{V_1 + I_1 Z_0}{2\sqrt{Z_0}} = \frac{\text{voltage wave incident on port 1}}{\sqrt{Z_0}} = \frac{V_{i1}}{\sqrt{Z_0}} \quad (6)$$

$$a_2 = \frac{V_2 + I_2 Z_0}{2\sqrt{Z_0}} = \frac{\text{voltage wave incident on port 2}}{\sqrt{Z_0}} = \frac{V_{i2}}{\sqrt{Z_0}} \quad (7)$$

Dependent variables  $b_1$ , and  $b_2$ , are normalized reflected voltages:

$$b_1 = \frac{V_1 - I_1 Z_0}{2\sqrt{Z_0}} = \frac{\text{voltage wave reflected from port 1}}{\sqrt{Z_0}} = \frac{V_{r1}}{\sqrt{Z_0}} \quad (8)$$

$$b_2 = \frac{V_2 - I_2 Z_0}{2\sqrt{Z_0}} = \frac{\text{voltage wave reflected from port 2}}{\sqrt{Z_0}} = \frac{V_{r2}}{\sqrt{Z_0}} \quad (9)$$

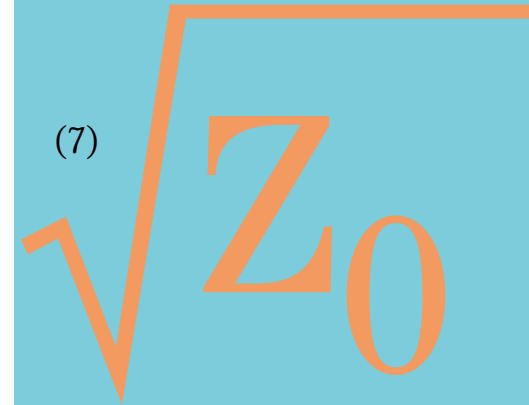

# 3 Using S-Parameters

The linear equations describing the two-port network are then:

$$b_1 = s_{11} a_1 + s_{12} a_2 \quad (10)$$

$$b_2 = s_{21} a_1 + s_{22} a_2 \quad (11)$$

The s-parameters  $s_{11}$ ,  $s_{22}$ ,  $s_{21}$ , and  $s_{12}$  are:

$$s_{11} = \left. \frac{b_1}{a_1} \right|_{a_2=0} = \text{Input reflection coefficient with the output port terminated by a matched load } (Z_L=Z_0 \text{ sets } a_2=0) \quad (12)$$

$$s_{22} = \left. \frac{b_2}{a_2} \right|_{a_1=0} = \text{Output reflection coefficient with the input terminated by a matched load } (Z_S=Z_0 \text{ sets } V_S=0) \quad (13)$$

$$s_{21} = \left. \frac{b_2}{a_1} \right|_{a_2=0} = \text{Forward transmission (insertion) gain with the output port terminated in a matched load.} \quad (14)$$

$$s_{12} = \left. \frac{b_1}{a_2} \right|_{a_1=0} = \text{Reverse transmission (insertion) gain with the input port terminated in a matched load.} \quad (15)$$

## Limitations of lumped models

At low frequencies most circuits behave in a predictable manner and can be described by a group of replaceable, lumped-equivalent black boxes. At microwave frequencies, as circuit element size approaches the wavelengths of the operating frequencies, such a simplified type of model becomes inaccurate. The physical arrangements of the circuit components can no longer be treated as black boxes. We have to use a distributed circuit element model and s-parameters.

# 3 Using S-Parameters

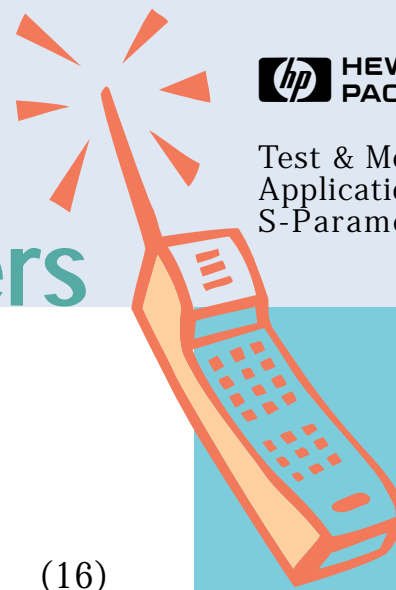

Notice that

$$s_{11} = \frac{b_1}{a_1} = \frac{\frac{V_1}{I_1} - Z_0}{\frac{V_1}{I_1} + Z_0} = \frac{Z_1 - Z_0}{Z_1 + Z_0} \quad (16)$$

$$\text{and } Z_1 = Z_0 \frac{(1 + s_{11})}{(1 - s_{11})} \quad (17)$$

where  $Z_1 = \frac{V_1}{I_1}$  is the input impedance at port 1.

This relationship between reflection coefficient and impedance is the basis of the Smith Chart transmission-line calculator. Consequently, the reflection coefficients  $s_{11}$  and  $s_{22}$  can be plotted on Smith charts, converted directly to impedance, and easily manipulated to determine matching networks for optimizing a circuit design.

## S-parameters

S-parameters and distributed models provide a means of measuring, describing, and characterizing circuit elements when traditional lumped-equivalent circuit models cannot predict circuit behavior to the desired level of accuracy. They are used for the design of many products, such as cellular telephones.

# 3 Using S-Parameters

## Smith Chart Transformation

The movie at the right animates the mapping between the complex impedance plane and the Smith Chart. The Smith Chart is used to plot reflectances, but the circular grid lines allow easy reading of the corresponding impedance. As the animation shows, the rectangular grid lines of the impedance plane are transformed to circles and arcs on the Smith Chart.

Vertical lines of constant resistance on the impedance plane are transformed into circles on the Smith Chart. Horizontal lines of constant reactance on the impedance plane are transformed into arcs on the Smith Chart. The transformation between the impedance plane and the Smith Chart is nonlinear, causing normalized resistance and reactance values greater than unity to become compressed towards the right side of the Smith Chart.

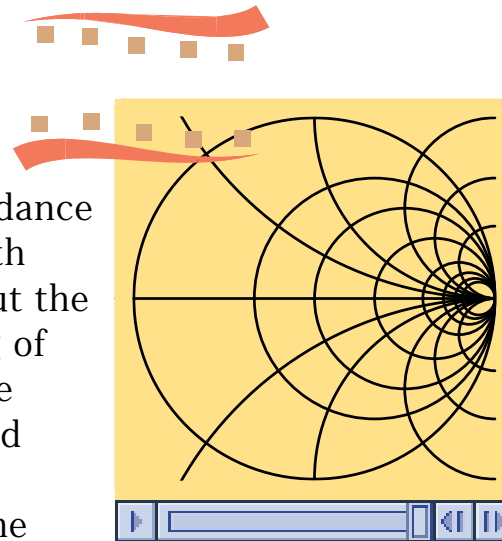

### Animation 1

Transformation between the impedance plane and the Smith Chart. Click over image to animate.

### Showing transformations graphically

To ease his RF design work, Bell Lab's Phillip H. Smith developed increasingly accurate and powerful graphical design aids. One version, a polar coordinate form, worked for all values of impedance components, but Smith suspected that a grid with orthogonal circles might be more practical. In 1937 he constructed the basic Smith Chart still used today, using a transformation developed by co-workers E.B. Ferrell and J.W. McRae that accommodates all data values from zero to infinity.

# 3 Using S-Parameters

## Advantages of S-Parameters

The previous equations show one of the important advantages of s-parameters, namely that they are simply gains and reflection coefficients, both familiar quantities to engineers.

By comparison, some of the y-parameters described earlier in this article are not so familiar. For example, the y-parameter corresponding to insertion gain  $s_{21}$  is the 'forward trans-admittance'  $y_{21}$  given by equation 3. Clearly, insertion gain gives by far the greater insight into the operation of the network.

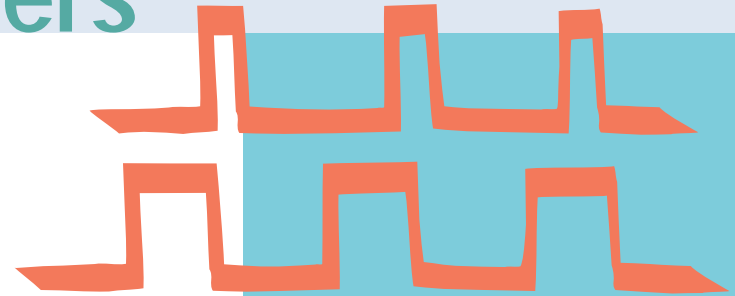
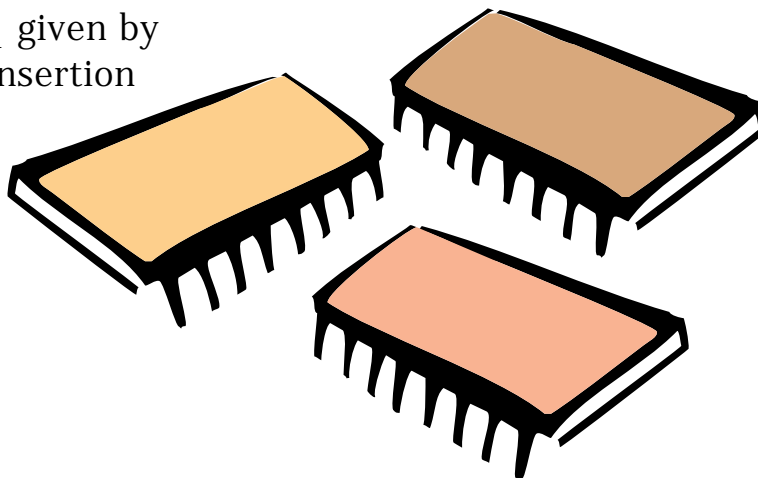

### Digital pulses

Digital pulses are comprised of high-order harmonic frequencies that determine the shape of the pulse. A short pulse with steep edges has a signal spectrum with relatively high power levels at very high frequencies. As a result, some elements in modern high-speed digital circuits require characterization with distributed models and s-parameters for accurate performance prediction.

# 3 Using S-Parameters

Another advantage of s-parameters springs from the simple relationship between the variables  $a_1$ ,  $a_2$ ,  $b_1$ , and  $b_2$ , and various power waves:

$$\begin{aligned} |a_1|^2 &= \text{Power incident on the input of the network.} \\ &= \text{Power available from a source impedance } Z_0. \end{aligned}$$

$$\begin{aligned} |a_2|^2 &= \text{Power incident on the output of the network.} \\ &= \text{Power reflected from the load.} \end{aligned}$$

$$\begin{aligned} |b_1|^2 &= \text{Power reflected from the input port of the network.} \\ &= \text{Power available from a } Z_0 \text{ source minus the power} \\ &\quad \text{delivered to the input of the network.} \end{aligned}$$

$$\begin{aligned} |b_2|^2 &= \text{Power reflected from the output port of the network.} \\ &= \text{Power incident on the load.} \\ &= \text{Power that would be delivered to a } Z_0 \text{ load.} \end{aligned}$$



## Radar

The development of radar, which uses powerful signals at short wavelengths to detect small objects at long distances, provided a powerful incentive for improved high frequency design methods during World War II. The design methods employed at that time combined distributed measurements and lumped circuit design. There was an urgent need for an efficient tool that could integrate measurement and design. The Smith Chart met that need.



# 3 Using S-Parameters

The previous four equations show that s-parameters are simply related to power gain and mismatch loss, quantities which are often of more interest than the corresponding voltage functions:

$$|s_{11}|^2 = \frac{\text{Power reflected from the network input}}{\text{Power incident on the network input}}$$

$$|s_{22}|^2 = \frac{\text{Power reflected from the network output}}{\text{Power incident on the network output}}$$

$$|s_{21}|^2 = \frac{\text{Power delivered to a } Z_0 \text{ load}}{\text{Power available from } Z_0 \text{ source}}$$

= Transducer power gain with  $Z_0$  load and source

$$|s_{12}|^2 = \text{Reverse transducer power gain with } Z_0 \text{ load and source}$$

# 4 Network Calculations with Scattering Parameters

## Signal Flow Graphs

Scattering parameters turn out to be particularly convenient in many network calculations. This is especially true for power and power gain calculations. The transfer parameters  $s_{12}$  and  $s_{21}$  are a measure of the complex insertion gain, and the driving point parameters  $s_{11}$  and  $s_{22}$  are a measure of the input and output mismatch loss. As dimensionless expressions of gain and reflection, the s-parameters not only give a clear and meaningful physical interpretation of the network performance, but also form a natural set of parameters for use with signal flow graphs [See references here and also in [Appendix A](#)].

Of course, it is not necessary to use signal flow graphs in order to use s-parameters, but flow graphs make s-parameter calculations extremely simple. Therefore, they are strongly recommended. Flow graphs will be used in the examples that follow.

## References

- J. K. Hunton, 'Analysis of Microwave Measurement Techniques by Means of Signal Flow Graphs,' IRE Transactions on Microwave Theory and Techniques, Vol. MTT-8, No. 2, March, 1960.
- N. Kuhn, 'Simplified Signal Flow Graph Analysis,' Microwave Journal, Vol. 6, No. 11, November, 1963.

# 4 Network Calculations with Scattering Parameters

In a signal flow graph, each port is represented by two nodes. Node  $a_n$  represents the wave coming into the device from another device at port  $n$ , and node  $b_n$  represents the wave leaving the device at port  $n$ . The complex scattering coefficients are then represented as multipliers on branches connecting the nodes within the network and in adjacent networks. Fig. 3, right, is the flow graph representation of the system of Fig. 2.

Figure 3 shows that if the load reflection coefficient  $\Gamma_L$  is zero ( $Z_L = Z_0$ ) there is only one path connecting  $b_1$  to  $a_1$  (flow graph rules prohibit signal flow against the forward direction of a branch arrow). This confirms the definition of  $s_{11}$ :

$$s_{11} = \left. \frac{b_1}{a_1} \right|_{a_2 = \Gamma_L b_2 = 0}$$

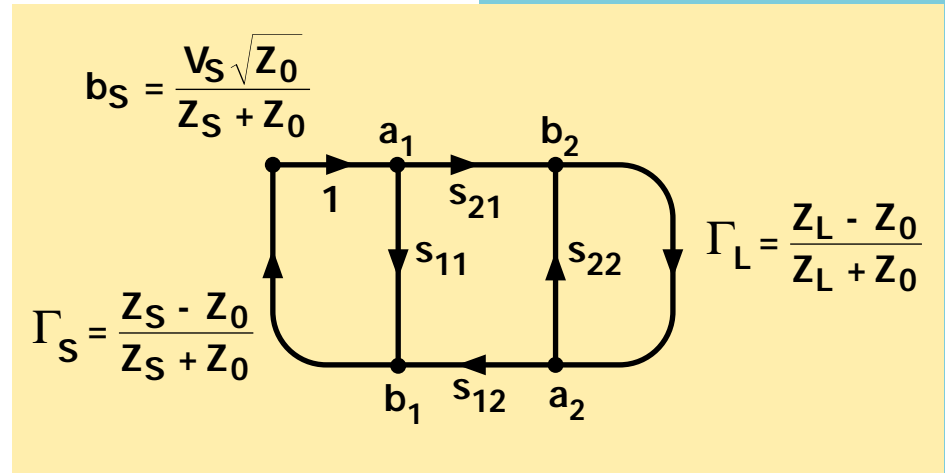

**Figure 3**  
Flow graph for two-port network appearing in [Figure 2](#).

# 4 Network Calculations with Scattering Parameters

The simplification of network analysis by flow graphs results from the application of the “non-touching loop rule.” This rule applies a generalized formula to determine the transfer function between any two nodes within a complex system. The non-touching loop rule is explained below.

## The Nontouching Loop Rule

The nontouching loop rule provides a simple method for writing the solution of any flow graph by inspection. The solution  $T$  (the ratio of the output variable to the input variable) is defined, where:

$$T = \frac{\sum_k T_k \Delta_k}{\Delta}$$

$T_k$  = path gain of the  $k^{\text{th}}$  forward path

$$\Delta = 1 - \sum (\text{all individual loop gains}) + \sum (\text{loop gain products of all possible combinations of 2 nontouching loops}) - \sum (\text{loop gain products of all possible combinations of 3 nontouching loops}) + \dots$$

$\Delta_k$  = The value of  $\Delta$  not touching the  $k^{\text{th}}$  forward path.

## Better Smith Charts

On the copyrighted Smith Chart, curves of constant standing wave ratio, constant attenuation, and constant reflection coefficient are all circles coaxial with the center of the diagram. Refinements to the original form have enhanced its usefulness. In an article published in 1944, for example, Smith described an improved version and showed how to use it with either impedance or admittance coordinates. More recent improvements include double Smith Charts for impedance matching and a scale for calculating phase distance.

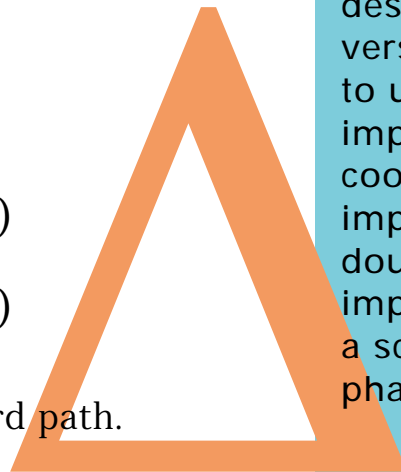

# 4 Network Calculations with Scattering Parameters

A path is a continuous succession of branches, and a forward path is a path connecting the input node to the output node, where no node is encountered more than once. Path gain is the product of all the branch multipliers along the path. A loop is a path that originates and terminates on the same node, no node being encountered more than once. Loop gain is the product of the branch multipliers around the loop.

For example, in [Figure 3](#) there is only one forward path from  $b_s$  to  $b_2$ , and its gain is  $s_{21}$ . There are two paths from  $b_s$  to  $b_1$ ; their path gains are  $s_{21}s_{12}G_L$  and  $s_{11}$  respectively. There are three individual loops, only one combination of two nontouching loops, and no combinations of three or more nontouching loops. Therefore, the value of D for this network is

$$D = 1 - (s_{11}G_S + s_{21}s_{12}G_LG_S + s_{22}G_L) + s_{11}s_{22}G_LG_S$$

The transfer function from  $b_s$  to  $b_2$  is therefore

$$\frac{b_2}{b_s} = \frac{s_{21}}{D}$$

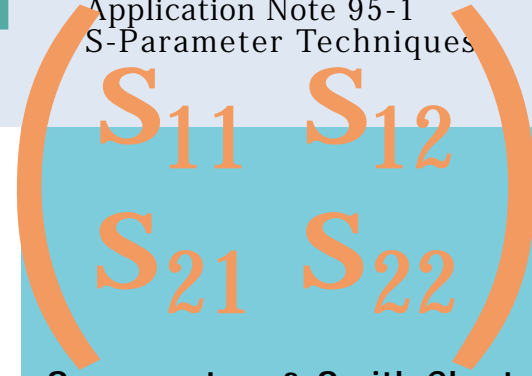

## S-parameters & Smith Charts

Invented in the 1960's, S-parameters are a way to combine distributed design and distributed measurement.  $s_{11}$  and  $s_{22}$ , the two s-parameters typically represented using Smith Charts, are similar to lumped models in many respects because they are related to the input impedance and output impedance, respectively. The Smith Chart performs a highly useful translation between the distributed and lumped models and is used to predict circuit and system behavior.

# 4 Network Calculations with Scattering Parameters

## Transducer Power Gain

Using scattering parameter flow-graphs and the non-touching loop rule, it is easy to calculate the transducer power gain with an arbitrary load and source. In the following equations, the load and source are described by their reflection coefficients  $G_L$  and  $G_S$ , respectively, referenced to the real characteristic impedance  $Z_0$ . Transducer power gain:

$$G_T = \frac{\text{Power delivered to the load}}{\text{Power available from the source}} = \frac{P_L}{P_{avS}}$$

$$P_L = P(\text{incident on load}) - P(\text{reflected from load})$$

$$= |b_2|^2 (1 - |G_L|^2)$$

$$P_{avS} = \frac{|b_S|^2}{(1 - |G_S|^2)}$$

$$G_T = \left| \frac{b_2}{b_S} \right|^2 (1 - |G_S|^2) (1 - |G_L|^2)$$



# 4 Network Calculations with Scattering Parameters

Using the non-touching loop rule,

$$\begin{aligned} \frac{b_2}{b_S} &= \frac{s_{21}}{1 - s_{11}\Gamma_S - s_{22}\Gamma_L - s_{21}s_{12}\Gamma_L\Gamma_S + s_{11}\Gamma_Ss_{22}\Gamma_L} \\ &= \frac{s_{21}}{(1 - s_{11}\Gamma_S)(1 - s_{22}\Gamma_L) - s_{21}s_{12}\Gamma_L\Gamma_S} \\ G_T &= \frac{|s_{21}|^2(1 - |\Gamma_S|^2)(1 - |\Gamma_L|^2)}{|(1 - s_{11}\Gamma_S)(1 - s_{22}\Gamma_L) - s_{21}s_{12}\Gamma_L\Gamma_S|^2} \end{aligned} \quad (18)$$

Two other parameters of interest are:

1) Input reflection coefficient with the output termination arbitrary and  $Z_S = Z_0$ .

$$\begin{aligned} s'_{11} &= \frac{b_1}{a_1} = \frac{s_{11}(1 - s_{22}\Gamma_L) + s_{21}s_{12}\Gamma_L}{1 - s_{22}\Gamma_L} \\ &= s_{11} + \frac{s_{21}s_{12}\Gamma_L}{1 - s_{22}\Gamma_L} \end{aligned} \quad (19)$$

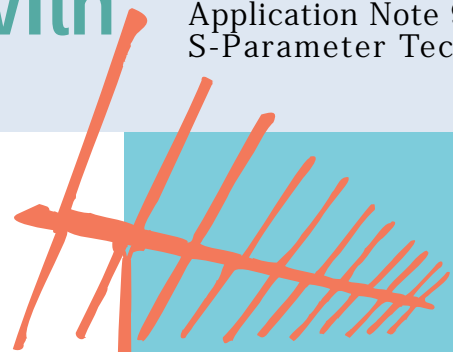

**Obtaining maximum performance**  
S-parameters are used to characterize RF and microwave components that must operate together, including amplifiers, transmission lines, and antennas (and free space). Because s-parameters allow the interactions between such components to be simply predicted and calculated, they make it possible to maximize performance in areas such as power transfer, directivity, and frequency response.

# 4 Network Calculations with Scattering Parameters

2) Voltage gain with arbitrary source and load impedances

$$\begin{aligned}
 A_V &= \frac{V_2}{V_1} & V_1 &= (a_1 + b_1)\sqrt{Z_0} = V_{i1} + V_{r1} \\
 & & V_2 &= (a_2 + b_2)\sqrt{Z_0} = V_{i2} + V_{r2} \\
 & & a_2 &= \Gamma_L b_2 \\
 & & b_1 &= s'_{11}a_1
 \end{aligned}
 \tag{20}$$

[Appendix B](#) contains formulas for calculating many often-used network functions (power gains, driving point characteristics, etc.) in terms of scattering parameters. Also included are conversion formulas between [s-parameters and h-, y-, and z-parameters](#), which are other parameter sets used very often for specifying transistors at lower frequencies.

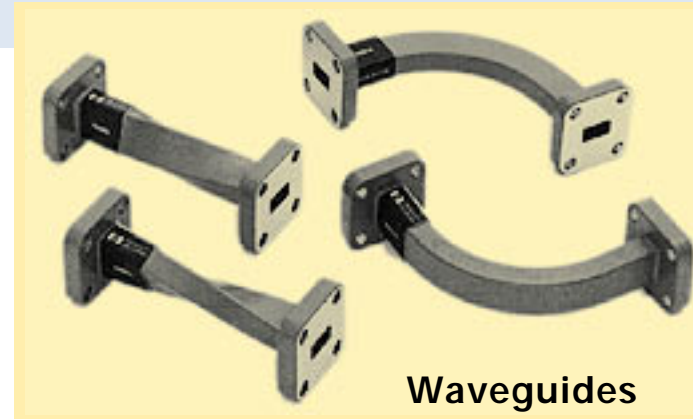

**Waveguides**

A radar system delivers a large amount of energy from a microwave ( $\mu\text{W}$ ) source to the transmitting antenna. The high field strengths cause short circuits in standard wires, cabling, and coax, so waveguides are used. These hollow metal tube constructions conduct  $\mu\text{W}$  energy much like a plumbing system. In the design of waveguides, we can test for signal reflections and transmission quality with s-parameters.



# 5 Amplifier Design

## Using Scattering Parameters

The remainder of this application note will show with several examples how s-parameters are used in the design of transistor amplifiers and oscillators. To keep the discussion from becoming bogged down in extraneous details, the emphasis in these examples will be on s-parameter design *methods*, and mathematical manipulations will be omitted wherever possible.

**Traveling wave amplifier**  
 S-parameters are extensively used for designing RF/ $\mu$ W circuits such as the HP TC702 distributed traveling wave amplifier (TWA) enlarged in the photograph below. The frequency-dependent impedances (or dispersion) in this integrated circuit can not be modeled by lumped-equivalent circuit elements, but s-parameters can accurately characterize the amplifier's response.



The HP 83017A microwave system amplifier achieves 0.5–26.5 GHz bandwidth by incorporating the HP TC702 GaAs MESFET TWA IC.

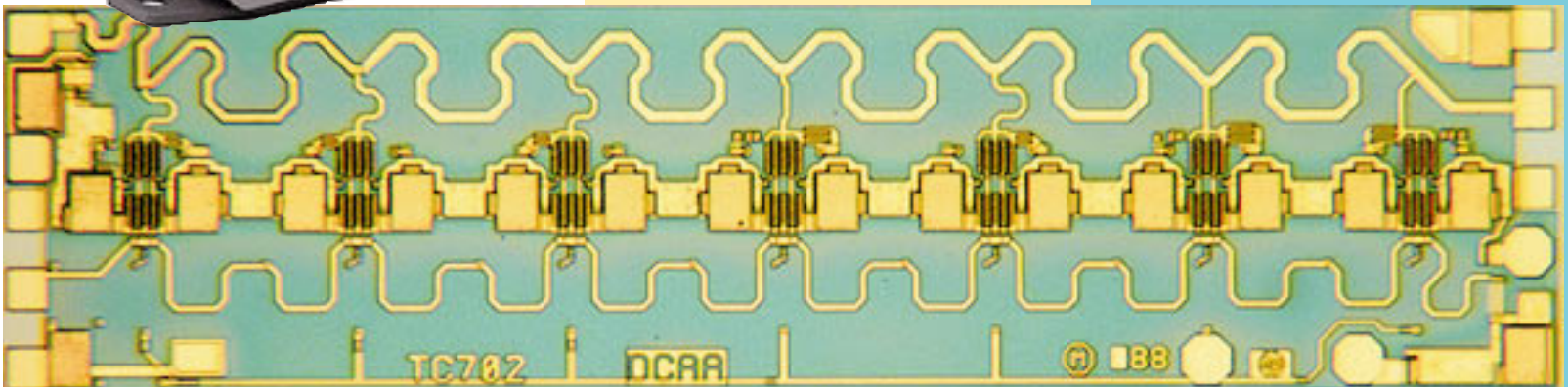

# 6 Measurement of S-Parameters

Most design problems will begin with a tentative selection of a device and the measurement of its s-parameters. Figures 4a – 4e, which appear to the right and on the next two pages, are a set of oscillograms showing complete s-parameter data between 100 MHz and 1.7 GHz for a 2N3478 transistor in the common-emitter configuration.

These graphs are the results of swept-frequency measurements made with the classic HP 8410A microwave network analyzer. They were originally published as part of the 1967 *HP Journal* article. Measurements made with a modern network analyzer are presented at the end of this section. While the measurement tools have changed over the past 30 years, the basic measurement techniques have not.

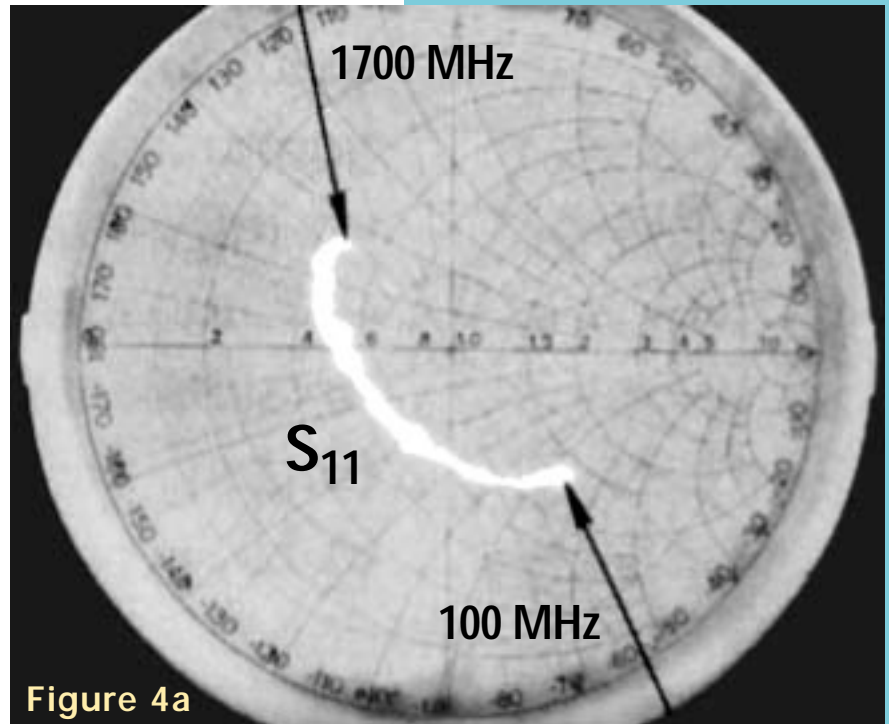

**Figure 4a**

$s_{11}$  of a 2N3478 transistor measured with the classic HP 8410A network analyzer. Outermost circle on Smith Chart overlay corresponds to  $|s_{11}| = 1$ . The movement of  $s_{11}$  with frequency is approximately along circles of constant resistance, indicative of series capacitance and inductance.

# 6 Measurement of S-Parameters

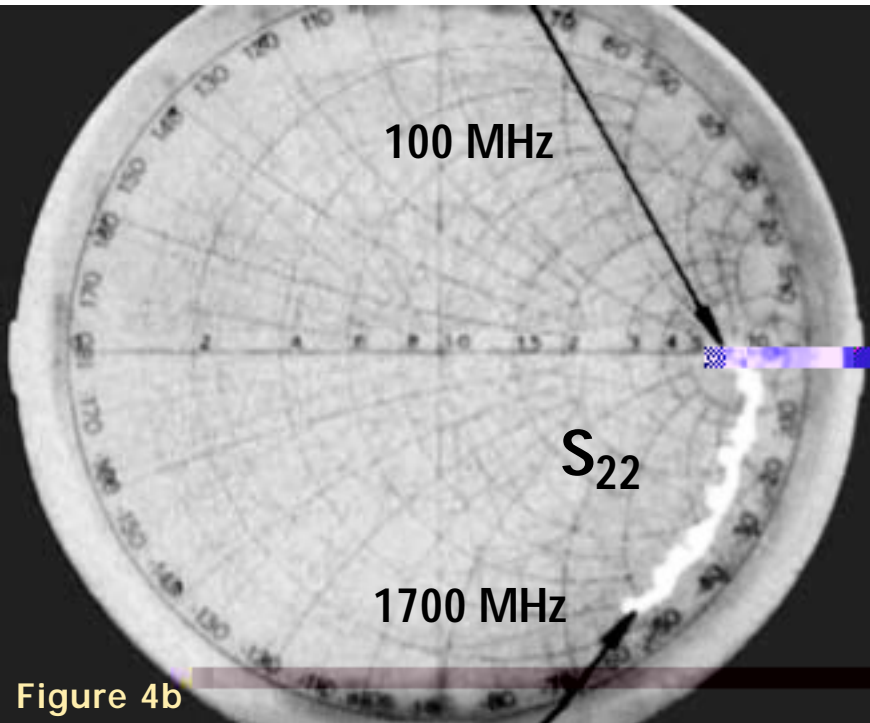

Figure 4b

Displayed on the same scale as Figure 4a,  $s_{22}$  moves between the indicated frequencies roughly along circles of constant conductance, characteristic of a shunt RC equivalent circuit.

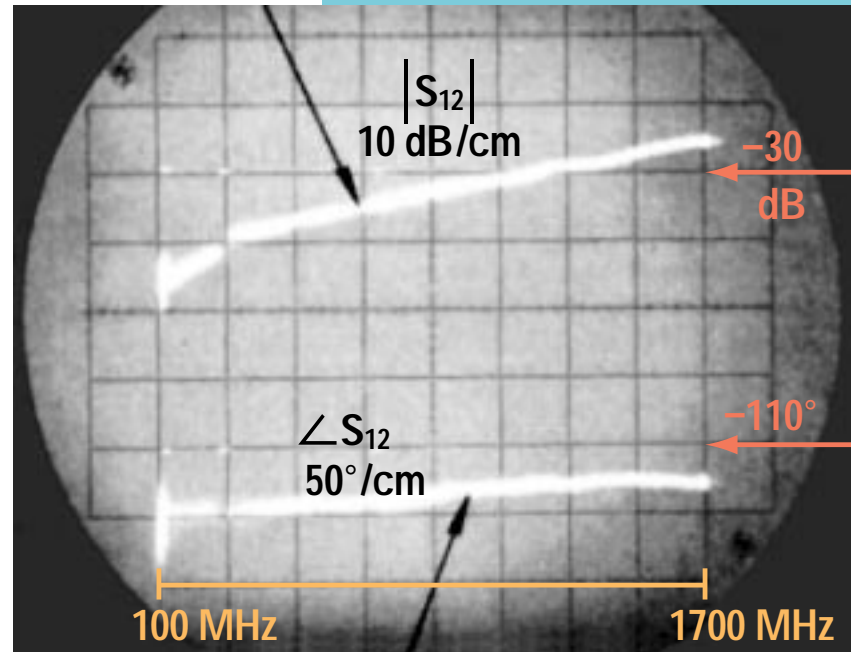
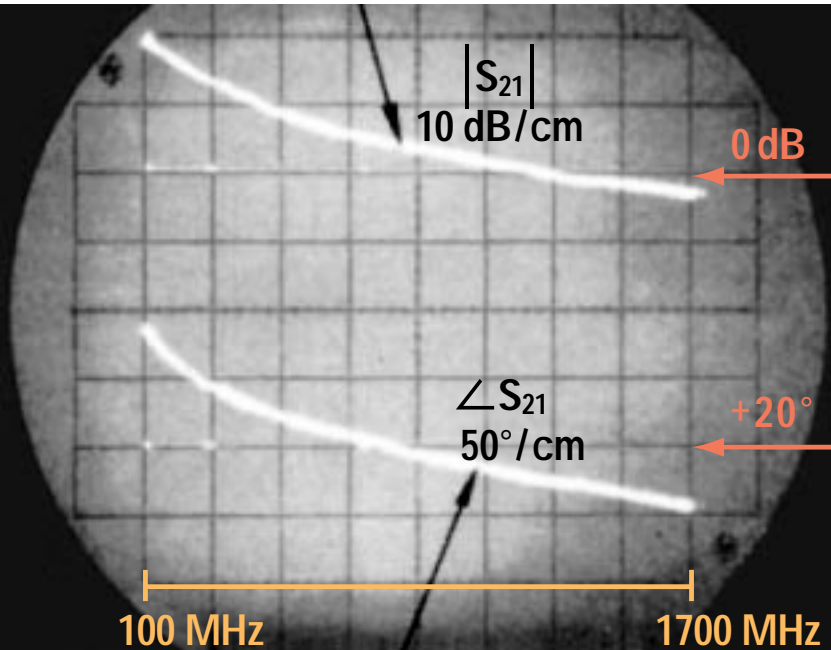

Figure 4c

Magnitude and phase of  $s_{12}$ . While the phase of  $s_{12}$  is relatively insensitive to the frequency, the magnitude of  $s_{12}$  increases about 6dB/octave.

# 6 Measurement of S-Parameters



**Figure 4d – Magnitude and phase of  $s_{21}$ .** The magnitude of  $s_{21}$  decays with a slope of about 6 dB/octave, while the phase decreases linearly above 500 MHz.

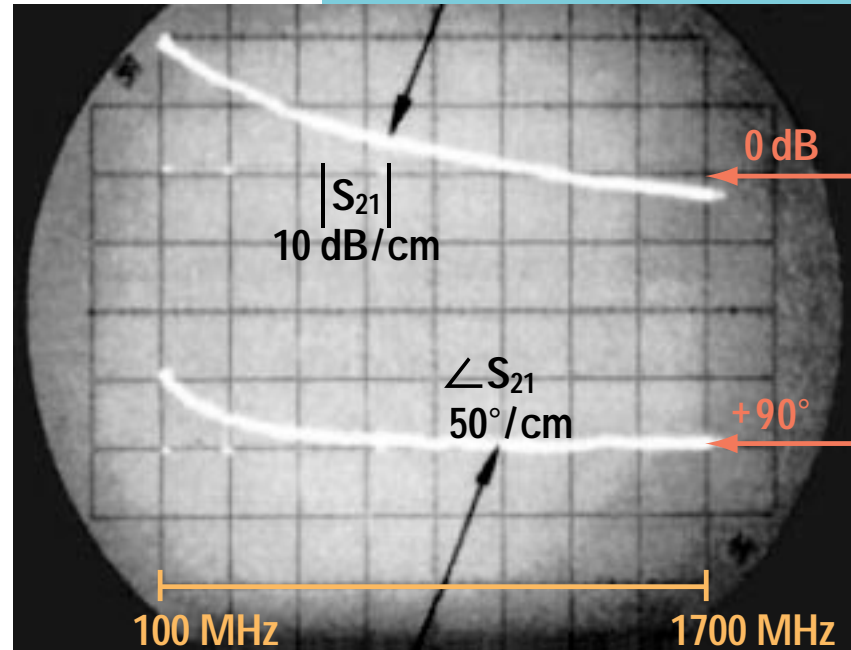

**Figure 4e – Removing Linear Phase Shift.** Magnitude and phase of  $s_{21}$  measured with a line stretcher adjusted to remove the linear phase shift above 500 MHz.

# 6 Measurement of S-Parameters

In Fig. 4f, the magnitude of  $s_{21}$  from Fig. 4d is replotted on a logarithmic frequency scale, along with additional data on  $s_{21}$  below 100 MHz, measured with a vector voltmeter. The magnitude of  $s_{21}$  is essentially constant to 125 MHz, and then it rolls off at a slope of 6 dB/octave.

The phase of  $s_{21}$ , as seen in Fig. 4d, varies linearly with frequency above about 500 MHz. By adjusting a calibrated line stretcher in the network analyzer, a compensating linear phase shift was introduced, and the phase curve of Fig. 4e resulted. To go from the phase curve of Fig. 4d to that of Fig. 4e required 3.35 cm of line, that is equivalent to a pure time delay of 112 picoseconds.

**Figure 4f**

Top curve:  $|s_{21}|$  from Fig. 4 is replotted on a logarithmic frequency scale. Data below 100 MHz was measured with an HP 8405A vector voltmeter. The bottom curve u, the unilateral figure of merit, calculated from s-parameters.

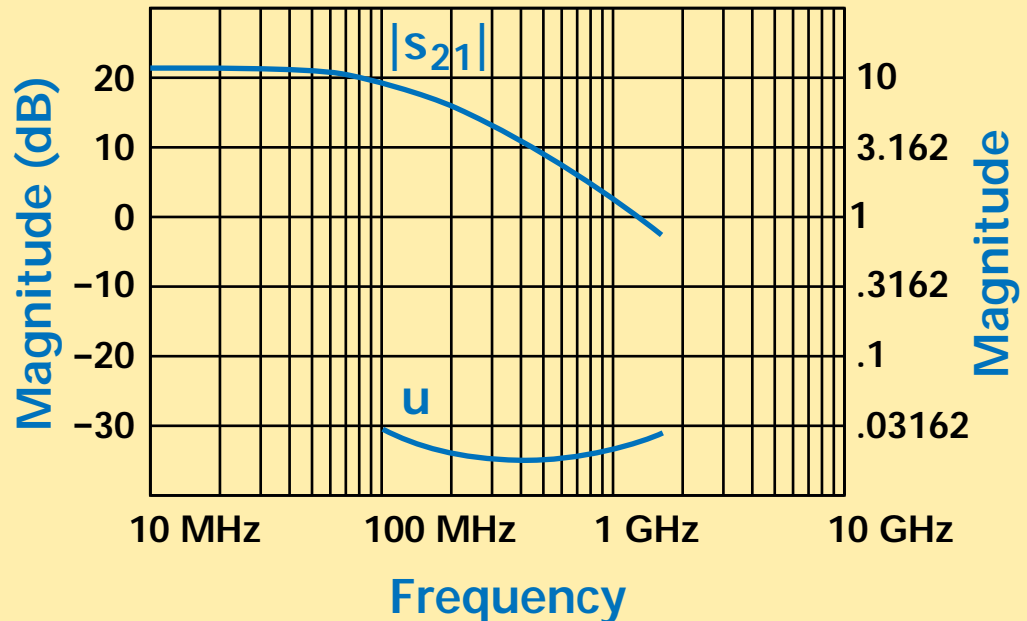

# 6 Measurement of S-Parameters

After removal of the constant-delay, or linear-phase, component, the phase angle of  $s_{21}$  for this transistor (Fig. 4e) varies from  $180^\circ$  at dc to  $+90^\circ$  at high frequencies, passing through  $+135^\circ$  at 125 MHz, the -3 dB point of the magnitude curve. In other words,  $s_{21}$  behaves like a single pole in the frequency domain, and it is possible to write a closed expression for it. This expression is

$$s_{21} = \frac{-s_{210}e^{-j\omega T_0}}{1 + j\frac{\omega}{\omega_0}} \quad (21)$$

where

$$T_0 = 112 \text{ ps}$$

$$\omega = 2 \text{ pf}$$

$$\omega_0 = 2 \text{ p}\nabla 125 \text{ MHz}$$

$$s_{210} = 11.2 = 21 \text{ dB}$$

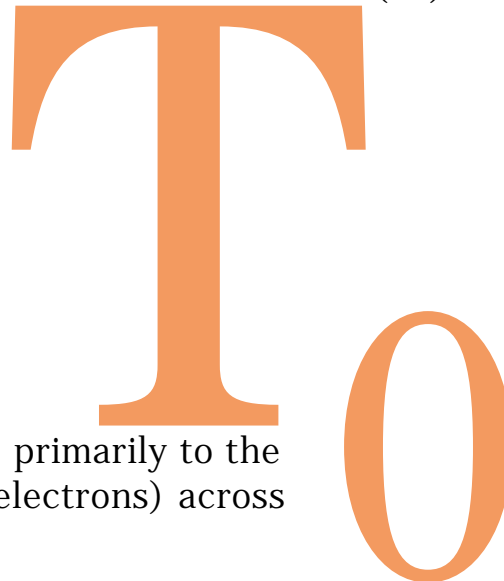

The time delay  $T_0 = 112 \text{ ps}$  is due primarily to the transit time of minority carriers (electrons) across the base of this npn transistor.

**Importance of simple approximations**  
Using first-order approximations such as equation 21 is an important step in circuit design. The intuitive sense that designers gain from developing an understanding of these approximations can eliminate much frustration. The acquired insight can save hours of time that otherwise might be wasted generating designs that cannot possibly be realized in the lab, while also decreasing development costs.

# 6 Measurement of S-Parameters

The s-parameters of an 2N3478 transistor shown in Figures 4a through 4f were measured with the classic HP 8410A network analyzer. In Figures 5a through 5e, the s-parameters of an 2N3478 transistor are shown re-measured with a modern HP 8753 network analyzer. Figures 5a through 5e represent the actual s-parameters of this transistor between 0.300 MHz and 1.00 GHz.

**Figure 5a**

S-parameters of 2N3478 transistor in common-emitter configuration, measured by an HP 8753 network analyzer. This plot shows  $S_{11}$  and  $S_{22}$  on a Smith Chart. The marker set at 47 MHz represents the -3 dB gain roll off point of  $s_{21}$ . The frequency index of this point is referenced in the other plots.

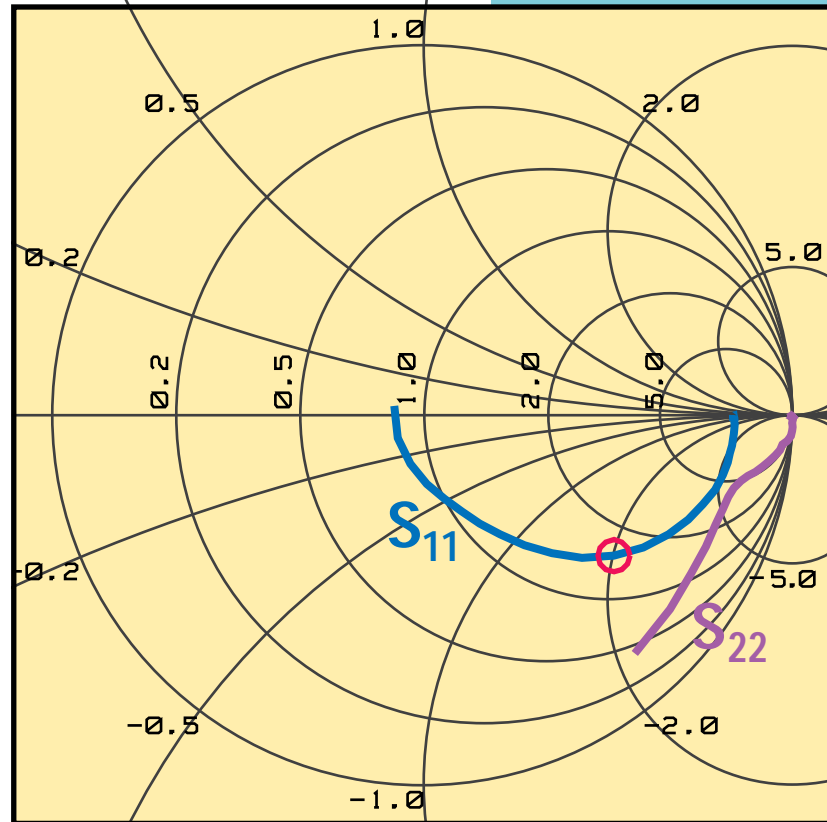

# 6 Measurement of S-Parameters

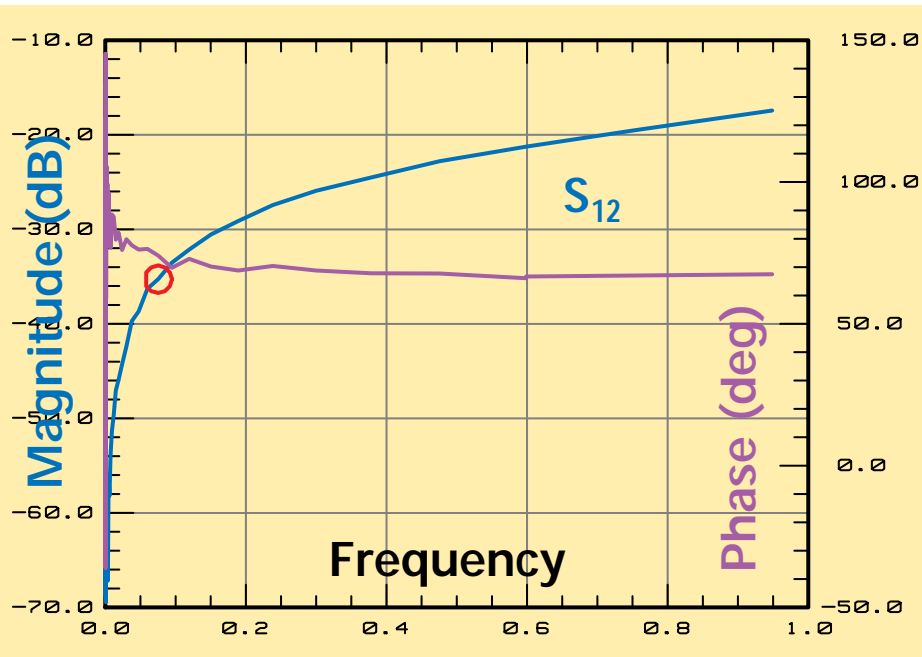

**Figure 5b**  
 A plot of the magnitude and phase of  $s_{12}$ . While the **phase** of  $s_{12}$  depends only weakly on the frequency,

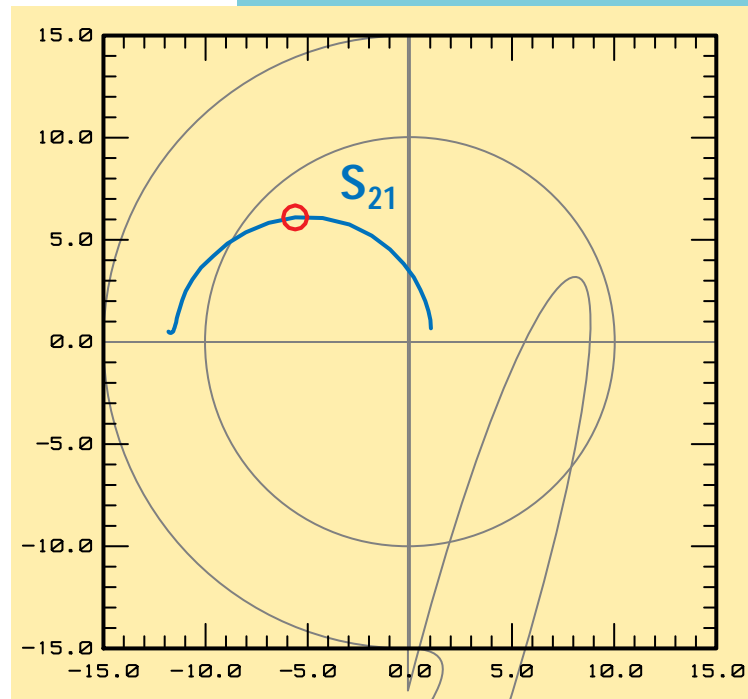
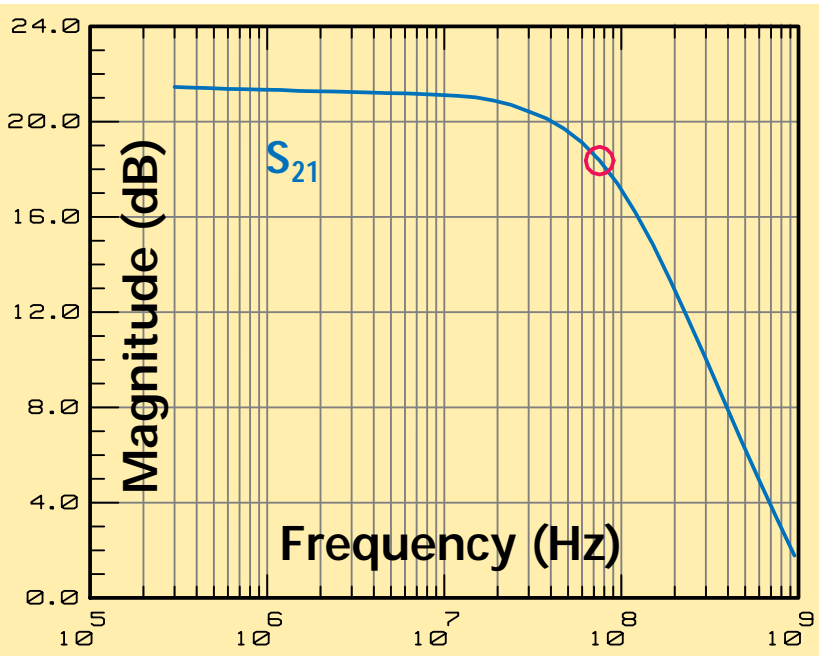

**Figure 5c**  
 A polar plot of  $s_{21}$ . The **frequency marker** shown is at the -3 dB point. Both the phase angle and magnitude decrease dramatically as the frequency is increased.

the **magnitude** increases rapidly at low frequencies.



# 6 Measurement of S-Parameters



**Figure 5d**  
The **magnitude** of  $s_{21}$  plotted on a log scale showing the 6 dB/octave roll-off above 75 MHz.

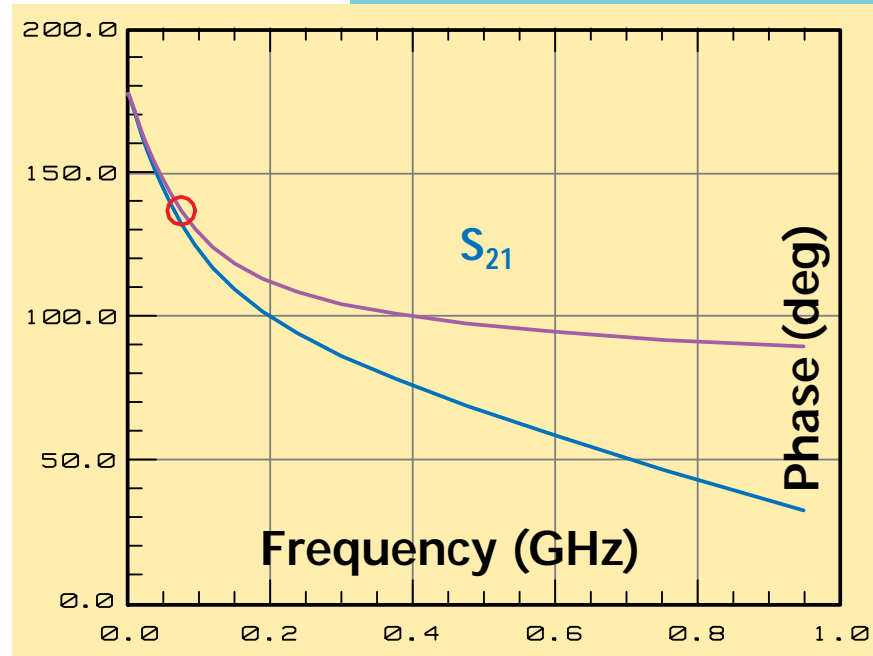

**Figure 5e**  
The phase angle, in degrees, of  $s_{21}$ . A time delay of 167 ps was de-embedded from the **measured data** using the analyzer's electrical-delay feature to get a **response** with a single-pole transfer characteristic. Removing this time delay allows the phase distortion to be viewed with much greater resolution.

# 6 Measurement of S-Parameters

In Fig. 5d, the magnitude of  $s_{21}$  from Fig. 5c is replotted on a logarithmic frequency scale. The magnitude of  $s_{21}$  is essentially constant to 75 MHz, and then rolls off at a slope of 6 dB/octave. The phase angle of  $s_{21}$  as seen in Fig. 5e varies linearly with frequency above 500 MHz. To better characterize phase distortion, a compensating linear phase shift was introduced electronically in the network analyzer. This established an accurate calibration for measuring the device, resulting in the [second phase curve](#) of [Figure 5e](#).

To go from the [first phase curve](#) of Fig. 5e to the [second phase curve](#) required removing a pure time delay of 167 picoseconds. Thirty years ago this operation was accomplished by de-embedding 5.0 cm of line using a calibrated line stretcher. Today it's performed by software in the network analyzer.

After removal of the constant-delay, or linear-phase, component, the phase angle of  $s_{21}$  for this transistor (Fig. 5e) varies from  $180^\circ$  at dc to  $+90^\circ$  at high frequencies, passing through  $+135^\circ$  at 75 MHz, the -3 dB point of the magnitude curve. In other words,  $s_{21}$  behaves like a single pole in the frequency domain.

## Vector Network Analyzers

Most modern design projects, RF through lightwave, use sophisticated simulation software to model system performance from components through subsystems. These programs require complete s-parameter data on each component. Measurements are made with a VNA, [Vector Network Analyzer](#), an instrument that accurately measures the s-parameters, transfer function, or impedance characteristic of linear networks across a broad range of frequencies.

# 6 Measurement of S-Parameters

Since  $s_{21}$  behaves like a single pole in the frequency domain, it is possible to write a closed expression for it. This expression is the same as equation 21, repeated here.

$$s_{21} = \frac{-s_{210} e^{-j\omega T_0}}{1 + j \frac{\omega}{\omega_0}} \quad \text{where}$$

$T_0 = 167 \text{ ps}$
$\omega = 2\pi f$
$\omega_0 = 2\pi \cdot 75 \text{ MHz}$
$s_{210} = 8.4 = 18.5 \text{ dB}$

The time delay  $T_0 = 167 \text{ ps}$  is due primarily to the transit time of minority carriers (electrons) across the base of this npn transistor. Removing this time delay using the electrical-delay feature of the vector network analyzer allows the phase distortion to be viewed with much greater resolution.

Using the first-order, single-pole approximation for  $s_{21}$  is an important step in circuit design. Today, however, we have design technology undreamed of in 1967. Subsequently, through the process of [electronic design automation \(EDA\)](#), computer-aided engineering (CAE) tools now can be used iteratively to simulate and refine the design. These tools combine accurate models with performance-optimization and yield-analysis capabilities.

## Complete network characterization

Vector Network Analyzers (VNA) are ideal for applications requiring complete network characterization. They use narrow-band detection to achieve wide dynamic range and provide noise-free data. VNAs are often combined with powerful computer-based [electronic design automation \(EDA\)](#) systems to both measure data, and simulate and optimize the performance of the complete system implementation being developed.

# 6 Measurement of S-Parameters

## Explanation of Measurement Discrepancies

You may have noticed a difference between the measured and calculated data from the 1967 *HP Journal* article and the data obtained for this updated application note. Both sets of data are fundamentally correct. Two major sources account for these differences:

**Measurement techniques** – Early network analyzers did not have onboard computers, an HP-IB standard, or high-resolution graphics to perform calibration, extract precision numerical data, or display electronic markers. Calibration techniques used in 1967 were procedurally and mathematically simpler than those used today. Modern network analyzers contain sophisticated automated techniques that enhance measurement processing capabilities and reduce operator errors.

**Device differences** – Semiconductor manufacturing processes evolve over time. Device engineers attempt to produce identical transistors with different processes. Nevertheless, successive generations of parts like the 2N3478 can exhibit unintentional, and sometimes unavoidable, performance differences, especially in characteristics not guaranteed on the datasheet.



# 7 Narrow-Band Amplifier Design

Suppose now that this 2N3478 transistor is to be used in a simple amplifier, operating between a  $50\ \Omega$  source and a  $50\ \Omega$  load, and optimized for power gain at 300 MHz by means of lossless input and output matching networks. Since reverse gain  $s_{12}$  for this transistor is quite small—50 dB smaller than forward gain  $s_{21}$ , according to Fig. 4—there is a possibility that it can be neglected. If this is so, the design problem will be much simpler, because setting  $s_{12}$  equal to zero will make the design equations much less complicated.

In determining how much error will be introduced by assuming  $s_{12} = 0$ , the first step is to calculate the unilateral figure of merit  $u$ , using the formula given in Appendix B. That is,

$$u = \frac{|s_{11}s_{12}s_{21}s_{22}|}{|(1 - |s_{11}|^2)(1 - |s_{22}|^2)|} \quad (22)$$

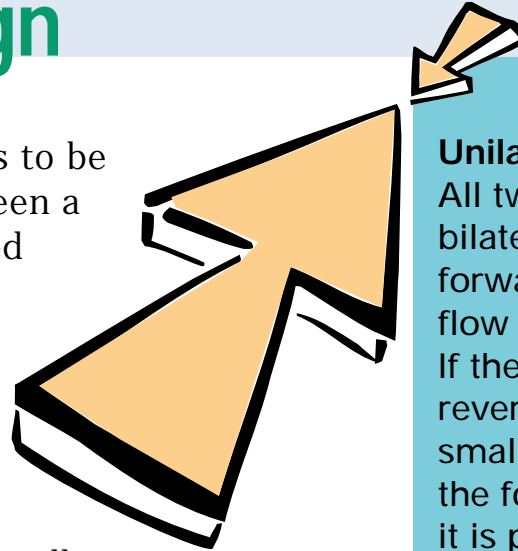

**Unilateral figure of merit**  
All two-port models are bilateral, so both the forward and reverse signal flow must be considered. If the signal flow in the reverse direction is much smaller than the flow in the forward direction, it is possible to make the simplification that the reverse flow is zero.

The unilateral figure of merit is a quick calculation that can be used to determine where this simplification can be made without significantly affecting the accuracy of the model.

# 7

## Narrow-Band Amplifier Design

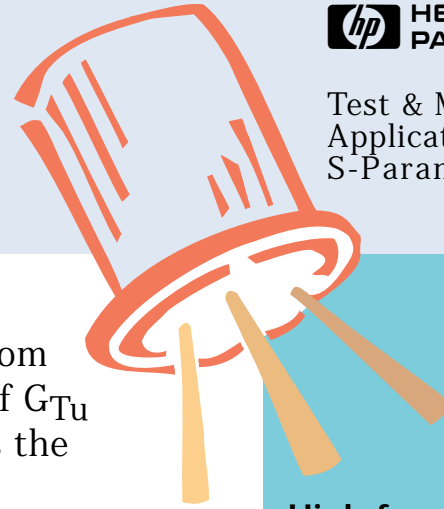

A plot of  $u$  as a function of frequency, calculated from the measured parameters, appears in Fig. 4f. Now if  $G_{Tu}$  is the transducer power gain with  $s_{12} = 0$  and  $G_T$  is the actual transducer power gain, the maximum error introduced by using  $G_{Tu}$  instead of  $G_T$  is given by the following relationship:

$$\frac{1}{(1 + u)^2} < \frac{G_T}{G_{Tu}} < \frac{1}{(1 - u)^2} \quad (23)$$

From Fig. 4f, the maximum value of  $u$  is about 0.03, so the maximum error in this case turns out to be about  $\pm 0.25$  dB at 100 MHz. This is small enough to justify the assumption that  $s_{12} = 0$ .

Incidentally, a small reverse gain, or feedback factor,  $s_{12}$ , is an important and desirable property for a transistor to have, for reasons other than it simplifies amplifier design. A small feedback factor means that the input characteristics of the completed amplifier will be independent of the load, and the output will be independent of the source impedance. In most amplifiers, isolation of source and load is an important consideration.

**High-frequency transistors**  
Discrete transistors were the mainstay of high-frequency system design in 1967 when Dick Anderson wrote the article on which this application note is based. Thirty years later, discrete devices are still available, manufactured and selected for specific, often exceptional, performance characteristics. Discrete transistors remain the best choice for many applications, such as sensitive first-stage amplifiers in satellite TV receivers.

# 7 Narrow-Band Amplifier Design

Returning now to the 300-MHz amplifier design, the unilateral expression for transducer power gain, obtained either by setting  $s_{12} = 0$  in equation 18 or looking in [Appendix B](#), is

$$G_{Tu} = \frac{|s_{21}|^2 (1 - |\Gamma_S|^2) (1 - |\Gamma_L|^2)}{|1 - s_{11}\Gamma_S|^2 |1 - s_{22}\Gamma_L|^2} \quad (24)$$

When  $|s_{11}|$  and  $|s_{22}|$  are both less than one, as they are in this case, maximum  $G_{Tu}$  occurs for  $\Gamma_S = s_{11}^*$  and  $\Gamma_L = s_{22}^*$  ([Appendix B](#)).

The next step in the design is to synthesize matching networks that will transform the 50  $\Omega$  load and source impedances to the impedances corresponding to reflection coefficients of  $s_{11}^*$  and  $s_{22}^*$ , respectively. Since this is to be a single-frequency amplifier, the matching networks need not be complicated. Simple series-capacitor, shunt-inductor networks will not only do the job, but will also provide a handy means of biasing the transistor—via the inductor—and of isolating the dc bias from the load and the source.

## Satellite Broadcast Signals

Satellites provide broad geographical signal coverage over a wide band of frequencies by using high power vacuum tubes, called Traveling Wave Tubes (TWTs), which are best characterized by s-parameters.

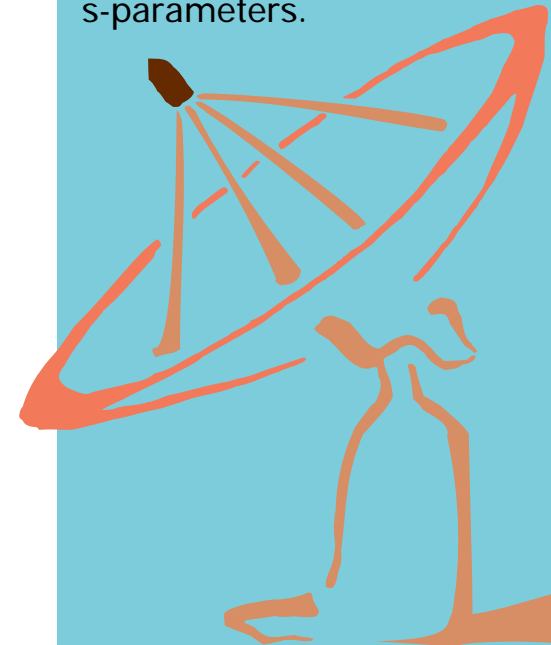

# 7 Narrow-Band Amplifier Design

Values of L and C to be used in the matching networks for the 300-MHz amplifier are determined using the Smith Chart of Fig. 6, which is shown on the next page. First, points corresponding to  $s_{11}$ ,  $s_{11}^*$ ,  $s_{22}$ , and  $s_{22}^*$  at 300 MHz are plotted. Each point represents the tip of a vector leading away from the center of the chart, its length equal to the magnitude of the reflection coefficient being plotted, and its angle equal to the phase of the coefficient.

Next, a combination of constant-resistance and constant-conductance circles is found, leading from the center of the chart, representing  $50 \Omega$ , to  $s_{11}^*$  and  $s_{22}^*$ . The circles on the Smith Chart are constant-resistance circles; increasing series capacitive reactance moves an impedance point counter-clockwise along these circles.

You will find an interactive Impedance Matching Model at the HP Test & Measurement website listed below. Challenge yourself to impedance matching games based on principles and examples discussed in this application note! Click on the URL below or type the address in your browser.

## Matching networks

Matching networks are extra circuit elements added to a device or circuit to cancel out or compensate for undesired characteristics or performance variations at specified frequencies. To eliminate reflections in an amplifier, one matching network is carefully designed to transform the  $50 \Omega$  load impedance to  $s_{11}^*$ . Another matching network transpedes the  $50 \Omega$  source impedance to  $s_{22}^*$ .

<http://www.hp.com/go/tminteractive>



# 7 Narrow-Band Amplifier Design

In this case, the circle to be used for finding series C is the one passing through the center of the chart, as shown by the solid line in Fig. 6.

Increasing shunt inductive susceptance moves impedance points clockwise along constant-conductance circles. These circles are like the constant-resistance circles, but they are on another Smith Chart, one that is just the reverse of the chart shown in Fig. 6.

The constant-conductance circles for shunt L all pass through the leftmost point of the chart rather than the rightmost point. The circles to be used are those passing through  $s_{11}^*$  and  $s_{22}^*$ , as shown by the dashed lines in Fig. 6.

**Figure 6**  
Smith Chart for 300-MHz amplifier design example.

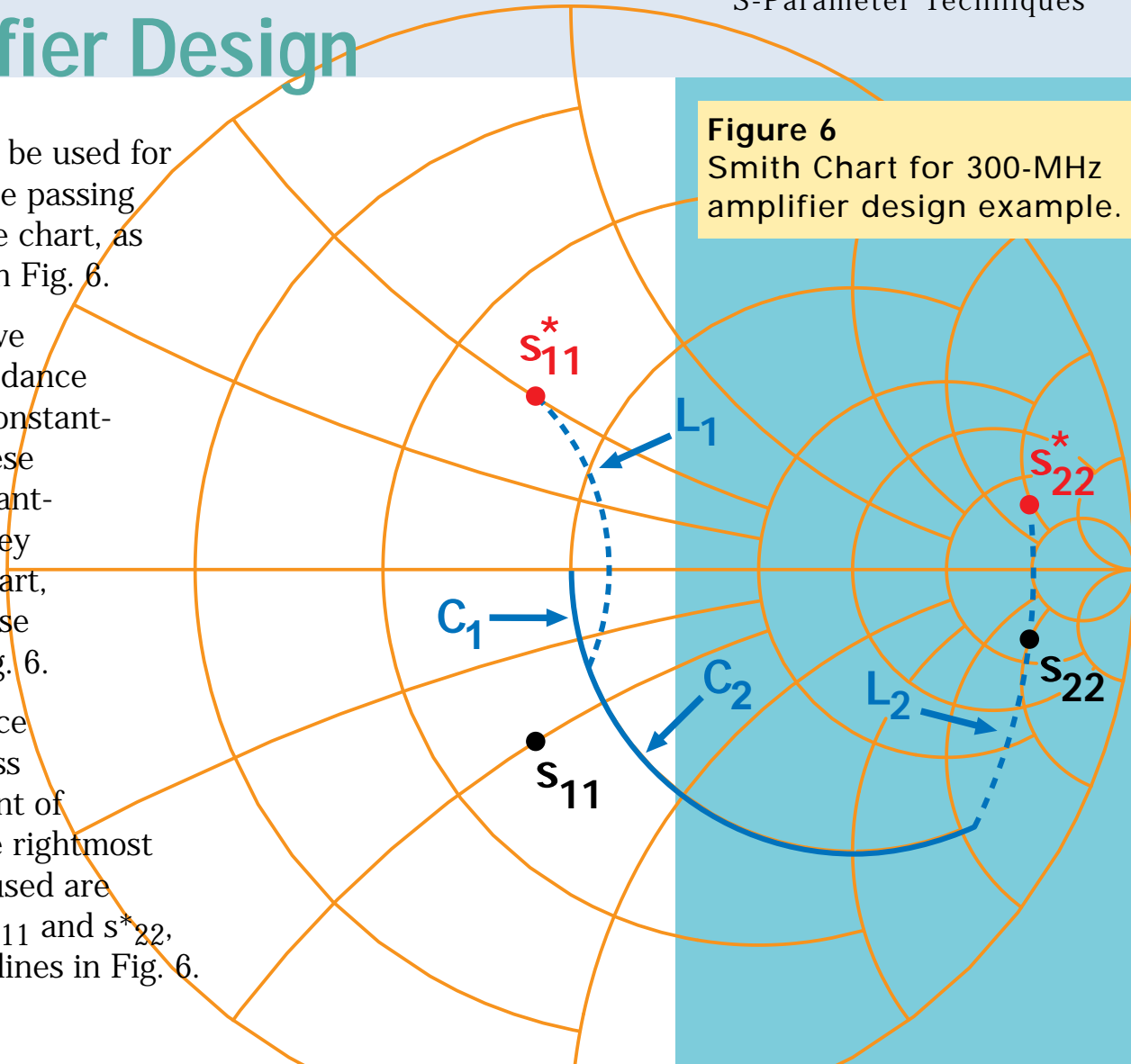

# 7 Narrow-Band Amplifier Design

Once these circles have been located, the normalized values of L and C needed for the matching networks are calculated from readings taken from the reactance and susceptance scales of the Smith Charts.

Each element's reactance or susceptance is the difference between the scale readings at the two end points of a circular arc. Which arc corresponds to which element is indicated in Fig. 6.

The final network and the element values, normalized and unnormalized, are shown in Fig. 7.

**Figure 7**  
A 300-MHz amplifier with matching networks for maximum power gain.

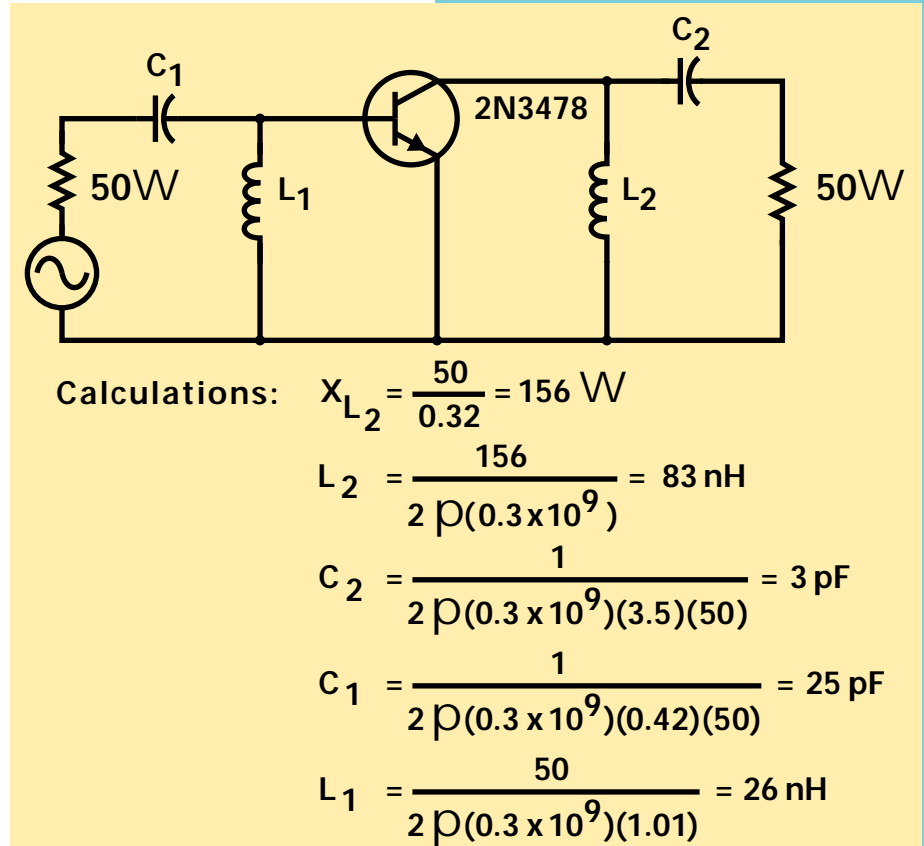

# 7 Narrow-Band Amplifier Design

The animation to the right demonstrates how to use a Smith Chart to design a matching network between a transistor output and a resistive load. As previously described, to maximize the power delivered to the load, the  $s_{22}^*$  parameter of the transistor must be matched to the load impedance,  $50 \Omega$  in this 300-MHz amplifier example. This matching is achieved using the LC circuit shown at the right.

Starting from the  $50 \Omega$  load, the series capacitance is varied to move the impedance point along the circle of constant  $50 \Omega$  resistance on the Smith Chart. The capacitance is adjusted until it intersects the constant conductance circle on which  $s_{22}^*$  is sitting. Varying the shunt inductance then moves the impedance point along this constant conductance circle as indicated by the admittance Smith Chart. To reach  $s_{22}^*$ , the shunt inductance is adjusted until the impedance point reaches  $s_{22}^*$ .

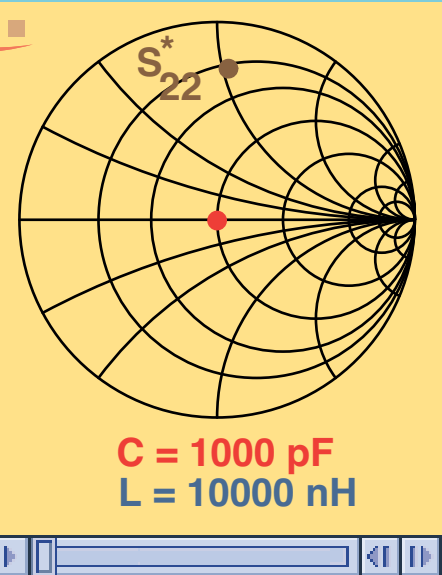
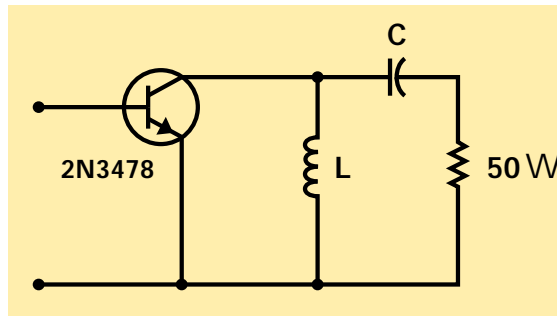

**Animation 2**  
Impedance matching using the Smith Chart for the matching network shown at the left. Click over the chart to start animation.

# 8 Broadband Amplifier Design

Designing a broadband amplifier, that is, one which has nearly constant gain over a prescribed frequency range, is a matter of surrounding a transistor with external elements in order to compensate for the variation of forward gain,  $|s_{21}|$  with frequency.

This can be done in either of two ways—first, negative feedback, or second, selective mismatching of the input and output circuitry. We will use the second method. When feedback is used, it is usually convenient to convert to y- or z-parameters (for shunt or series feedback, respectively) using the conversion equations given in [Appendix B](#) and a digital computer.

[Equation 24](#) for the unilateral transducer power gain can be factored into three parts, as shown to the right:

$$G_{Tu} = G_0 G_1 G_2$$

$$G_0 = |s_{21}|^2$$

$$G_1 = \frac{1 - |\Gamma_S|^2}{|1 - s_{11}\Gamma_S|^2}$$

$$G_2 = \frac{1 - |\Gamma_L|^2}{|1 - s_{22}\Gamma_L|^2}$$

# 8 Broadband Amplifier Design

When a broadband amplifier is designed by selective mismatching, the gain contributions of  $G_1$  and  $G_2$  are varied to compensate for the variations of  $G_0 = |s_{21}|^2$  with frequency.

Suppose that the 2N3478 transistor whose s-parameters are given in Fig. 4 is to be used in a broadband amplifier that will operate from 300 MHz to 700 MHz. The amplifier is to be driven from a  $50 \Omega$  source and is to drive a  $50 \Omega$  load.

[According to Figure 4f,](#)

$$\begin{aligned} |s_{21}|^2 &= 13 \text{ dB at } 300 \text{ MHz} \\ &= 10 \text{ dB at } 450 \text{ MHz} \\ &= 6 \text{ dB at } 700 \text{ MHz} \end{aligned}$$

To realize an amplifier with a constant gain of 10 dB, source and load matching networks must be found that will decrease the gain by 3 dB at 300 MHz, leave the gain the same at 450 MHz, and increase the gain by 4 dB at 700 MHz.

# dB

# 8 Broadband Amplifier Design

Although in the general case both a source matching network and a load matching network would be designed,  $G_{1\max}$  (i.e.,  $G_1$  for  $\Gamma_s = s_{11}^*$ ) for this transistor is less than 1 dB over the frequencies of interest, which means there is little to be gained by matching the source. Consequently, for this example, only a load-matching network will be designed. Procedures for designing source-matching networks are identical to those used for designing load-matching networks.

The first step in the design of the load-matching network is to plot  $s_{22}^*$  over the required frequency range on the Smith Chart, Fig. 8a.

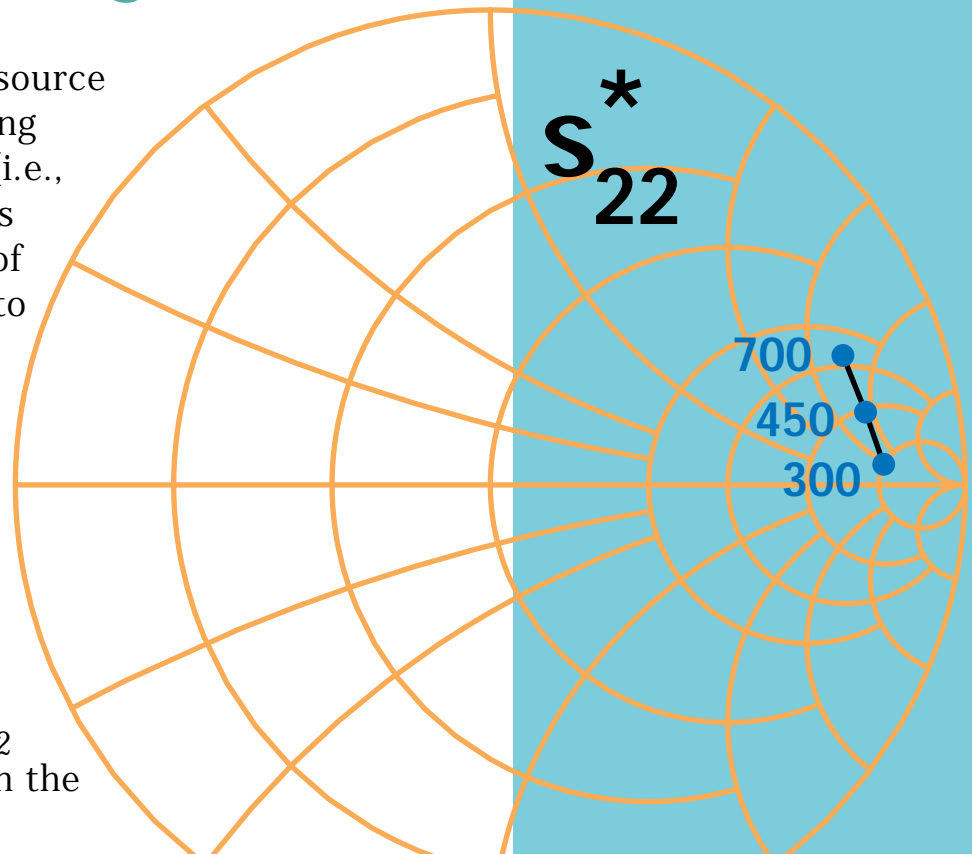

**Figure 8a**  
A plot of  $s_{22}^*$  over the frequency range from 300 MHz to 700 MHz.

# 8 Broadband Amplifier Design

Next, a set of constant-gain circles is drawn. As shown in Fig. 8b, each circle is drawn for a single frequency; its center is on a line between the center of the Smith Chart and the point representing  $s_{22}^*$  at that frequency. The distance from the center of the Smith Chart to the center of the constant gain circle is given by the following equations, which also appear in [Appendix B](#):

$$r_2 = \frac{1 - g_2 |s_{22}|}{1 - |s_{22}|^2 (1 - g_2)}$$

where

$$g_2 = \frac{G_2}{G_{2 \max}} = G_2 (1 - |s_{22}|^2)$$

The radius of the constant-gain circle is:

$$\rho_2 = \frac{\sqrt{1 - g_2 (1 - |s_{22}|^2)}}{1 - |s_{22}|^2 (1 - g_2)}$$

**Figure 8**  
Constant-gain circles.

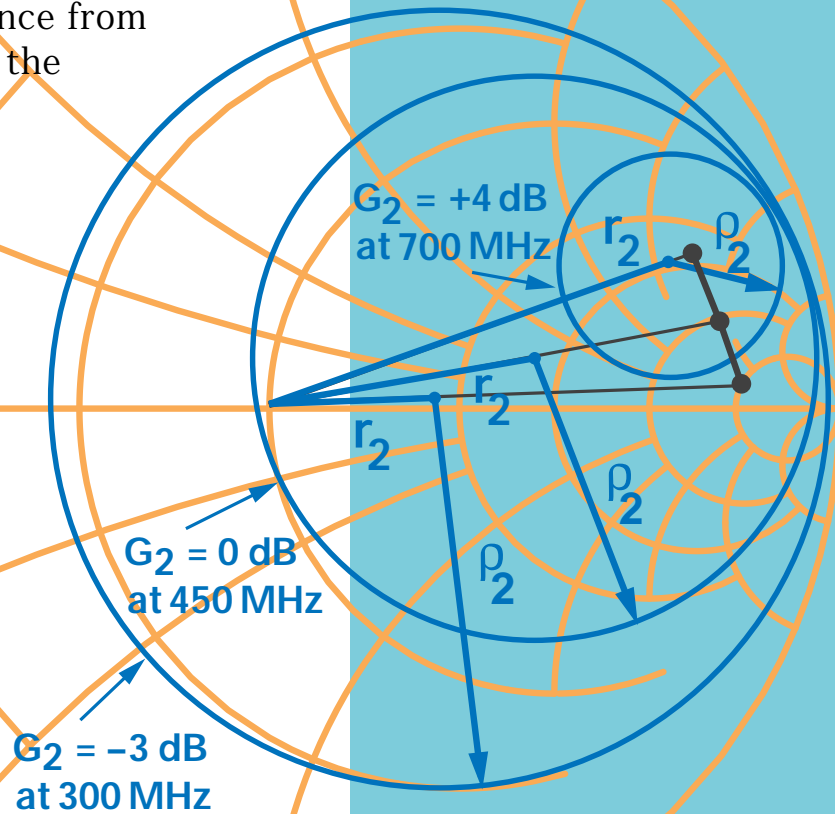

# 8 Broadband Amplifier Design

For this example, three circles will be drawn, one for  $G_2 = -3$  dB at 300 MHz, one for  $G_2 = 0$  dB at 450 MHz, and one for  $G_2 = +4$  dB at 700 MHz. Since  $|s_{22}|$  for this transistor is constant at 0.85 over the frequency range [see Figure 4(b)],  $G_{2\max}$  for all three circles is  $(0.278)^{-1}$ , or 5.6 dB. The three constant-gain circles are indicated in Fig. 8b.

The required matching network must transform the center of the Smith Chart, representing  $50 \Omega$  to some point on the  $-3$  dB circle at 300 MHz, to some point on the  $0$  dB circle at 450 MHz, and to some point on the  $+4$  dB circle at 700 MHz. There are undoubtedly many networks that will do this. One satisfactory solution is a combination of two inductors, one in shunt and one in series, as shown in Fig. 9.

**Figure 9**  
A combination of shunt and series inductances is a suitable matching network for the broadband amplifier.

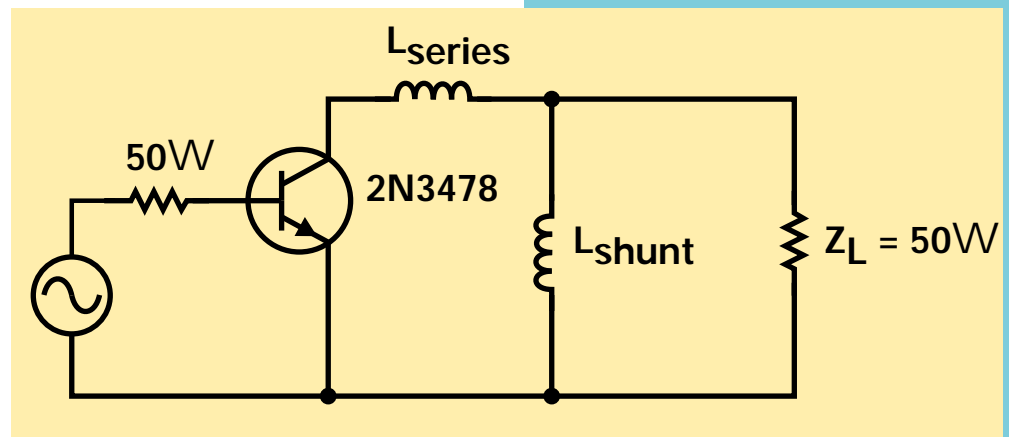



# 8 Broadband Amplifier Design



Test & Measurement  
Application Note 95-1  
S-Parameter Techniques

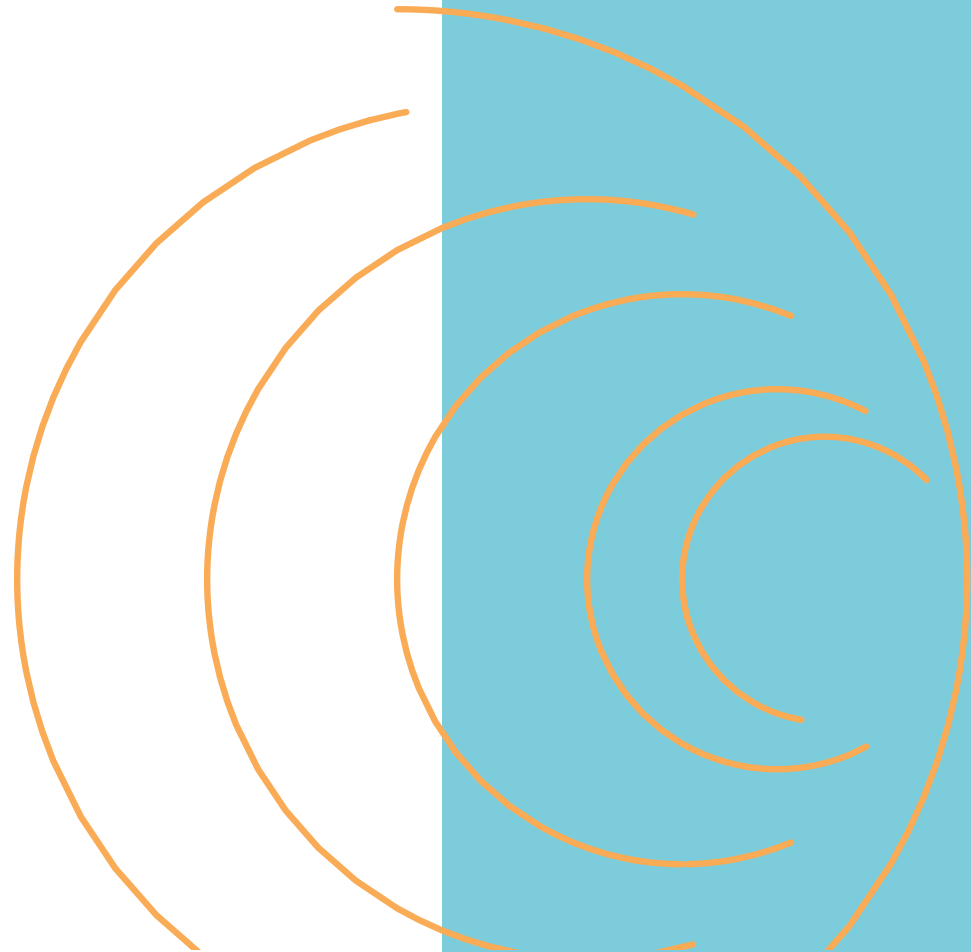

# 8 Broadband Amplifier Design

Once appropriate constant-conductance and constant-resistance circles have been found, the reactances and susceptances of the elements can be read directly from the Smith Chart. Then the element values are calculated, the same as they were for the narrow-band design.

Figure 10b is a schematic diagram of the completed broadband amplifier, with unnormalized element values.

**Figure 10b**

Broadband amplifier with constant gain of 10 dB from 300 MHz to 700 MHz.

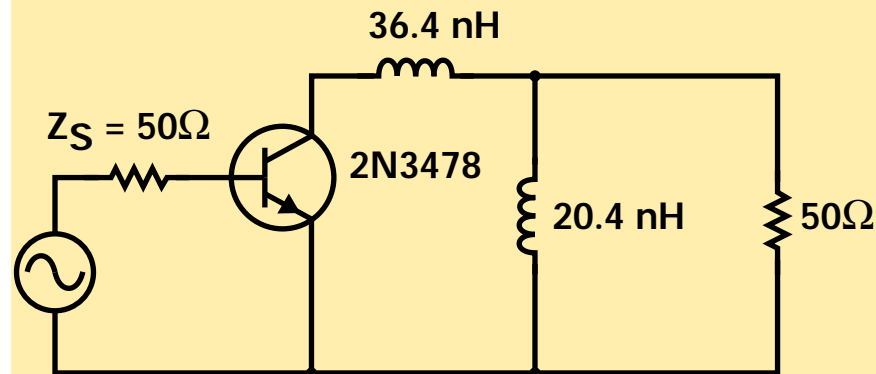

Inductance Calculations:

$$\text{From 700 MHz data, } \frac{j\omega L_{\text{series}}}{Z_0} = j(3.64 - 0.44) = j3.2$$

$$L_{\text{series}} = \frac{(3.2)(50)}{2\pi(0.7)} \text{ nH} = 36.4 \text{ nH}$$

$$\text{From 300 MHz data, } \frac{Z_0}{j\omega L_{\text{shunt}}} = -j1.3$$

$$L_{\text{shunt}} = \frac{50}{(1.3)(2\pi)(0.3)} = 20.4 \text{ nH}$$

# 9

## Stability Considerations

### Design of Reflection Amplifiers and Oscillators

When the real part of the input impedance of a network is negative, the corresponding input reflection coefficient ([Equation 17](#)) is greater than one, and the network can be used as the basis for two important types of circuits, reflection amplifiers and oscillators. A reflection amplifier (Fig. 11) can be realized with a circulator—a nonreciprocal three-port device—and a negative-resistance device.

The circulator is used to separate the incident (input) wave from the larger wave reflected by the negative-resistance device. Theoretically, if the circulator is perfect and has a positive real characteristic impedance  $Z_0$ , an amplifier with infinite gain can be built by selecting a negative-resistance device whose input impedance has a real part equal to  $-Z_0$  and an imaginary part equal to zero (the imaginary part can be set equal to zero by tuning if necessary).

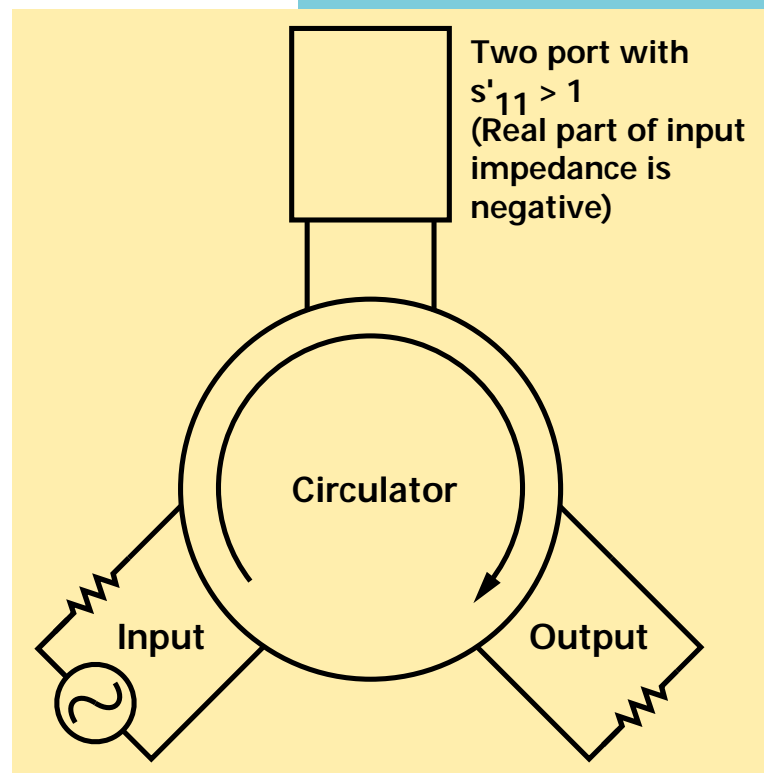

**Figure 11**  
Reflection amplifier consists of circulator and transistor with negative input resistance.

# 9

## Stability Considerations

Amplifiers, of course, are not supposed to oscillate, whether they are reflection amplifiers or some other kind. There is a convenient criterion based upon scattering parameters for determining whether a device is stable or potentially unstable with given source and load impedances. Referring again to the flow graph of [Figure 3](#), the ratio of the reflected voltage wave  $b_1$  to the input voltage wave  $b_s$  is

$$\frac{b_1}{b_s} = \frac{s_{\phi 1}}{1 - G_s s_{\phi 1}}$$

where  $s_{\phi 1}$  is the input reflection coefficient with  $G_s = 0$  ( $Z_2 = Z_0$ ) and an arbitrary load impedance  $Z_L$ , as defined in [Equation 19](#).

If at some frequency

$$G_s s_{\phi 1} = 1 \quad (25)$$

the circuit is unstable and it will oscillate at that frequency.

On the other hand, if

$$\left| s_{\phi 1} \right| < \left| \frac{1}{G_s} \right|$$

the device is unconditionally stable and will not oscillate, whatever the phase angle of  $G_s$  might be.

### Computer Aided Engineering tools (CAE)

CAE software tools are used in the design process to simulate actual device and circuit behavior so designs can be evaluated before they're built. The CAE approach is faster, produces accurate results, and is easier to follow than manual methods using graphical design aids. CAE tools are part of the total engineering solution.

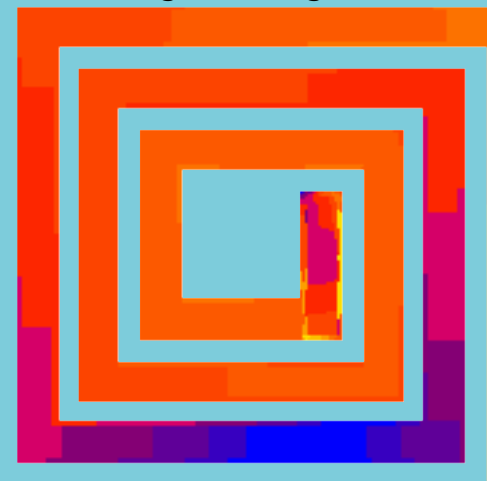

# 9

## Stability Considerations

To see how these principles of stability are applied in design problems, consider the transistor oscillator design illustrated in Fig. 12. In this case the input reflection coefficient  $s'_{11}$  is the reflection coefficient looking into the collector circuit, and the 'source' reflection coefficient  $\Gamma_s$  is one of the two tank-circuit reflection coefficients,  $\Gamma_{T1}$  or  $\Gamma_{T2}$ . From equation 19,

$$s'_{11} = s_{11} + \frac{s_{12}s_{21}\Gamma_L}{1 - s_{22}\Gamma_L}$$

**Figure 12** The transistor oscillator is designed by choosing a tank circuit such that  $\Gamma_s s'_{11} = 1$

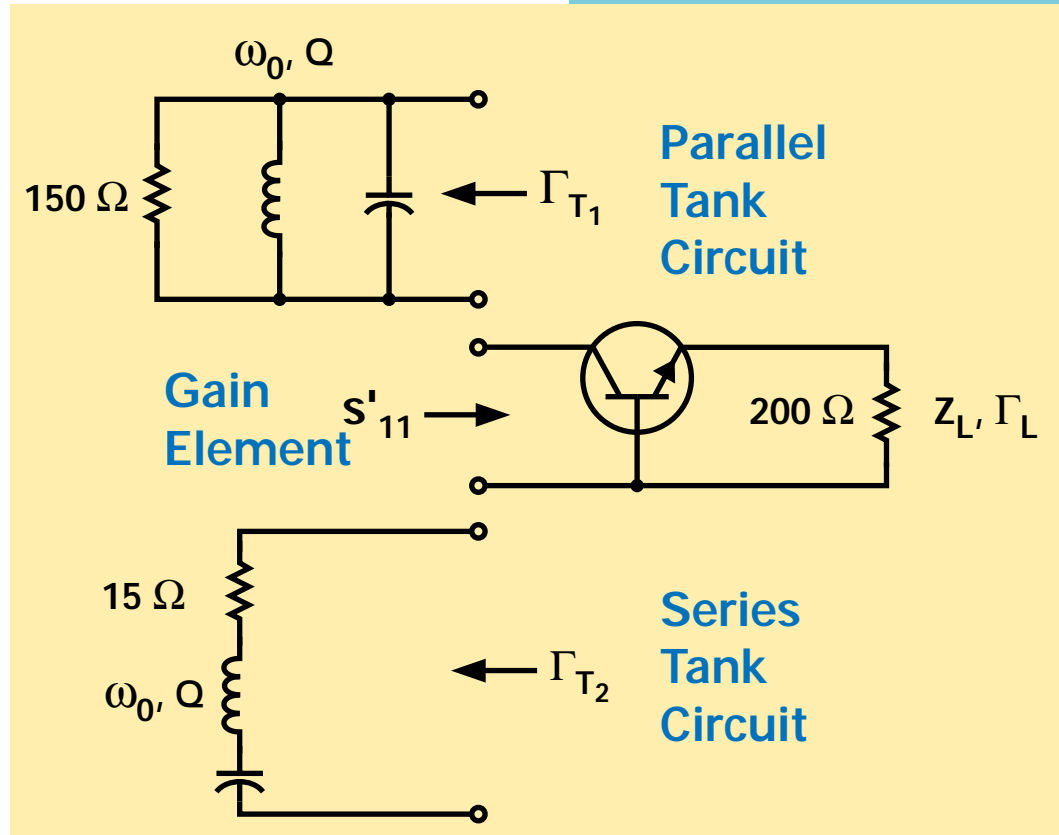

# 9 Stability Considerations

To make the transistor oscillate,  $s\Gamma_{11}$  and  $G_S$  must be adjusted so that they satisfy equation 25. There are four steps in the design procedure:

- Measure the four scattering parameters of the transistor as functions of frequency.
- Choose a load reflection coefficient  $\Gamma_L$  that makes  $s\Gamma_{11}$  greater than unity. In general, it may also take an external feedback element that increases  $s_{12} s_{21}$  to make  $s\Gamma_{11}$  greater than one.
- Plot  $1/s\Gamma_{11}$  on a Smith Chart. (If the network analyzer is being used to measure the s-parameters of the transistor,  $1/s\Gamma_{11}$  can be measured directly by reversing the reference and test channel connections between the reflection test unit and the harmonic frequency converter. The polar display with a Smith Chart overlay then gives the desired plot immediately.)
- Connect either the series or the parallel tank circuit to the collector circuit and tune it so that  $G_{T1}$  or  $G_{T2}$  is large enough to satisfy equation 25. (The tank circuit reflection coefficient plays the role of  $G_S$  in this equation.)

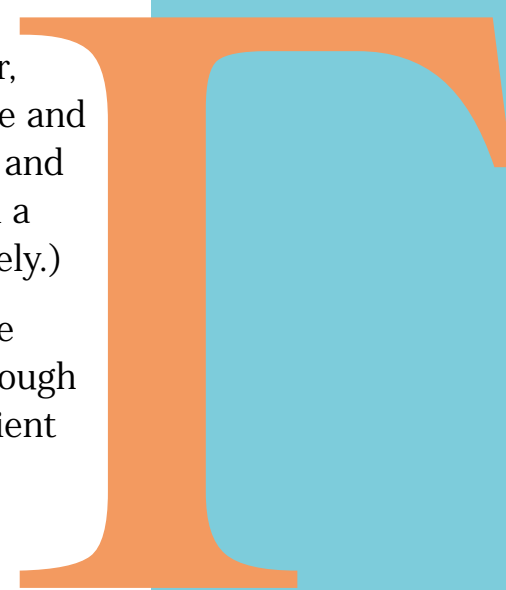

# 9

Figure 13 shows a Smith Chart plot of  $1/s\Gamma_{11}$  for a high frequency transistor in the common-base configuration. Load impedance  $Z_L$  is  $200 \Omega$ , which means that  $G_L$  referred to  $50 \Omega$  is 0.6. Reflection coefficients  $G_{T1}$  and  $G_{T2}$  are also plotted as functions of the resonant frequencies of the two tank circuits. Oscillations occur when the locus of  $G_{T1}$  or  $G_{T2}$  passes through the shaded region. Thus, this transistor would oscillate from 1.5 to 2.5 GHz with a series tuned circuit, and from 2.0 to 2.7 GHz with a parallel tuned circuit.

— Dick Anderson, 1967 and 1997

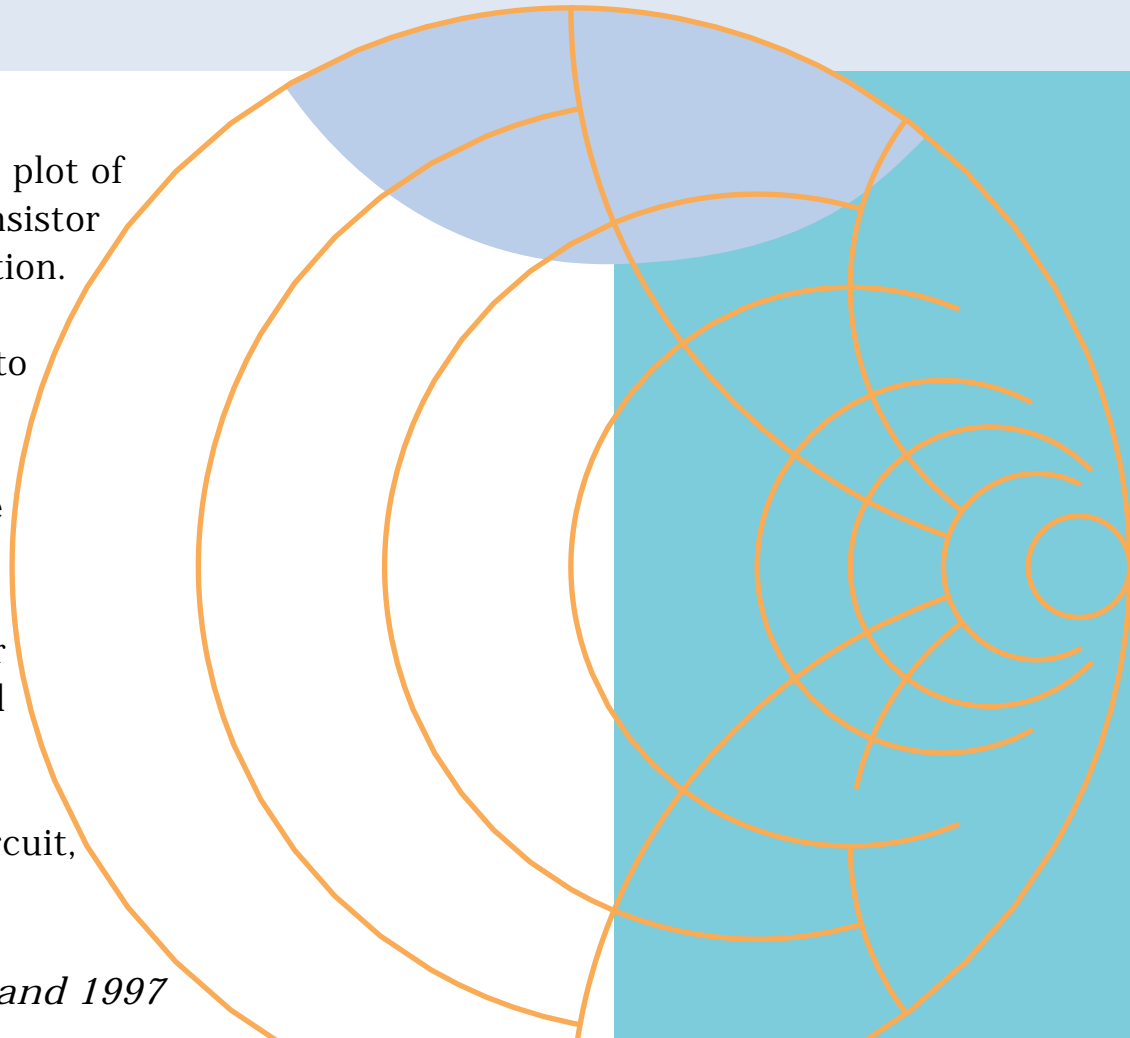

# A Additional Reading on S-Parameters

In addition to previous references listed earlier and repeated again here, the following papers and books were listed in the 1967 *HP Journal* article as sources for information on s-parameter design procedures and flow graphs. Current references are also mentioned.

- J. K. Hunton, 'Analysis of Microwave Measurement Techniques by Means of Signal Flow Graphs,' IRE Transactions on Microwave Theory and Techniques, Vol. MTT- 8, No. 2, March, 1960.
- D.C Youla, 'On Scattering Matrices Normalized to Complex Port Numbers,' Proc. IRE, Vol. 49, No. 7, July, 1961.
- J.G. Linvill and J.F. Gibbons, 'Transistors and Active Circuits,' McGraw-Hill, 1961. (No s-parameters, but good treatment of Smith Chart design methods.)
- N. Kuhn, 'Simplified Signal Flow Graph Analysis,' Microwave Journal, Vol. 6, No, 11, November, 1963.
- K. Kurokawa, 'Power Waves and the Scattering Matrix,' IEEE Transactions on Microwave Theory and Techniques, Vol. MTT-13, No. 2, March, 1965.

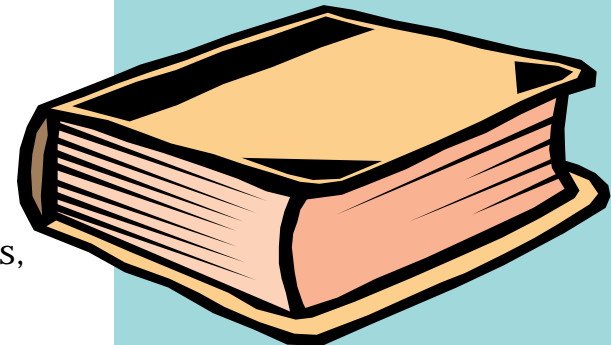



# A Additional Reading on S-Parameters

- F. Weinert, ‘Scattering Parameters Speed Design of High-Frequency Transistor Circuits,’ *Electronics*, Vol. 39, No. 18, Sept. 5, 1966.
- G. Fredricks, ‘How to Use S-Parameters for Transistor Circuit Design,’ *EEE* Vol. 14, No. 12, Dec., 1966.

Among many modern reference sources on the subject, the following book, first published in 1969, is definitely a classic:

- Smith, Phillip H., ‘Electronic Applications of the Smith Chart in Waveguide, Circuit and Component Analysis,’ Noble Publishing Classic Series, Tucker, Georgia, 1995, ISBN-1-884932-39-8, 237 pp.

We also mention a useful textbook containing 5 chapters, 2 appendices, and problem sets. This text presents a unified treatment of the analysis and design of microwave transistor amplifiers using scattering parameters techniques:

- G. Gonzalez, ‘Microwave Transistor Amplifiers: Analysis and Design,’ Prentice Hall, 1984, ISBN 0-13-581646-7, 240 pp.

## Keep up to date

This book by P. H. Smith referenced here must be considered the ultimate source on Smith Charts. Many excellent articles on the use of Smith charts have appeared in trade publications such as the *Microwave Journal*, and educational Smith Chart software is sold over the internet.

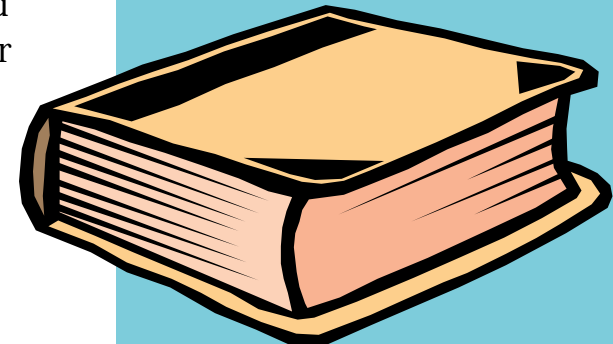

# B Scattering Parameter Relationships

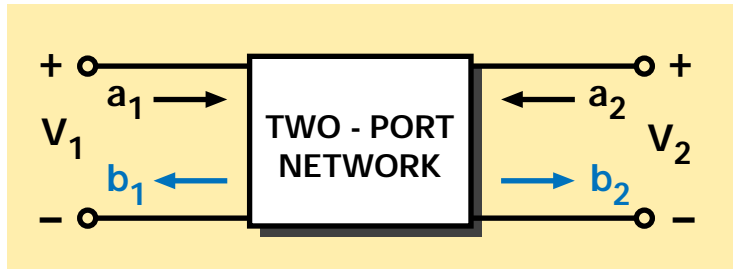

$$b_1 = s_{11} a_1 + s_{12} a_2$$

$$b_2 = s_{21} a_1 + s_{22} a_2$$

Input reflection coefficient with arbitrary  $Z_L$

$$s'_{11} = s_{11} + \frac{s_{12} s_{21} \Gamma_L}{1 - s_{22} \Gamma_L}$$

Output reflection coefficient with arbitrary  $Z_S$

$$s'_{22} = s_{22} + \frac{s_{12} s_{21} \Gamma_S}{1 - s_{11} \Gamma_S}$$

Voltage gain with arbitrary  $Z_L$  and  $Z_S$

$$A_V = \frac{V_2}{V_1} = \frac{s_{21}(1 + \Gamma_L)}{(1 - s_{22} \Gamma_L)(1 + s'_{11})}$$

# B Scattering Parameter Relationships

## Power Gain

$$G = \frac{\text{Power delivered to load}}{\text{Power input to network}} = \frac{|s_{21}|^2 \frac{\Re\{G_L\}}{\Gamma_L} - |G_L|^2 \frac{\Re\{N\}}{\Gamma_L}}{\frac{\Re\{G_L\}}{\Gamma_L} - |s_{11}|^2 \frac{\Re\{N\}}{\Gamma_L} + |G_L|^2 \frac{\Re\{M\}}{\Gamma_L} |s_{22}|^2 - |D|^2 \frac{\Re\{N\}}{\Gamma_L} - 2\Re(G_L N)}$$

## Available Power Gain

$$G_A = \frac{\text{Power available from network}}{\text{Power available from source}} = \frac{|s_{21}|^2 \frac{\Re\{G_L\}}{\Gamma_L} - |G_S|^2 \frac{\Re\{M\}}{\Gamma_L}}{\frac{\Re\{G_L\}}{\Gamma_L} - |s_{22}|^2 \frac{\Re\{M\}}{\Gamma_L} + |G_S|^2 \frac{\Re\{N\}}{\Gamma_L} |s_{11}|^2 - |D|^2 \frac{\Re\{M\}}{\Gamma_L} - 2\Re(G_S M)}$$

## Transducer Power Gain

$$G_T = \frac{\text{Power delivered to load}}{\text{Power available from source}} = \frac{|s_{21}|^2 \frac{\Re\{G_L\}}{\Gamma_L} - |G_S|^2 \frac{\Re\{M\}}{\Gamma_L} - |G_L|^2 \frac{\Re\{N\}}{\Gamma_L}}{\left| (1 - s_{11} G_S)(1 - s_{22} G_L) - s_{12} s_{21} G_L G_S \right|^2}$$

# B Scattering Parameter Relationships

Unilateral Transducer Power Gain ( $s_{12} = 0$ )

$$G_{Tu} = \frac{|s_{21}|^2 \left(1 - |\Gamma_S|^2\right) \left(1 - |\Gamma_L|^2\right)}{|1 - s_{11}\Gamma_S|^2 |1 - s_{22}\Gamma_L|^2} = G_0 G_1 G_2$$

Maximum Unilateral Transducer Power Gain when  $|s_{11}| < 1$

and  $|s_{22}| < 1$ . Maximum obtained for  $\Gamma_S = s_{11}^*$  and  $\Gamma_L = s_{22}^*$

$$G_u = \frac{|s_{21}|^2}{\left| \left(1 - |s_{11}|^2\right) \left(1 - |s_{22}|^2\right) \right|} = G_0 G_{1 \max} G_{2 \max}$$

$$G_0 = |s_{21}|^2$$

$$G_1 = \frac{1 - |\Gamma_S|^2}{|1 - s_{11}\Gamma_S|^2}$$

$$G_2 = \frac{1 - |\Gamma_L|^2}{|1 - s_{22}\Gamma_L|^2}$$

$$G_{i \max} = \frac{1}{1 - |s_{ii}|^2}$$

$i = 1, 2$

# B Scattering Parameter Relationships

## Constant Gain Circles (Unilateral case: $s_{12} = 0$ )

- center of constant gain circle is on line between center of Smith Chart and point representing  $s_{ii}^*$
- distance of center of circle from center of Smith Chart:

$$r_i = \frac{g_i |s_{ii}|}{1 - |s_{ii}|^2 (1 - g_i)}$$

- radius of circle:

$$\rho_i = \frac{\sqrt{1 - g_i (1 - |s_{ii}|^2)}}{1 - |s_{ii}|^2 (1 - g_i)}$$

where  $i = 1, 2$ , and

$$g_i = \frac{G_i}{G_{i \max}} = G_i (1 - |s_{ii}|^2)$$

Constant Gain Circle



$r_i$

$\rho_i$

$s_{ii}^*$

# B Scattering Parameter Relationships

## Unilateral Figure of Merit

$$u = \frac{|s_{11}s_{22}s_{12}s_{21}|}{|(1-|s_{11}|^2)(1-|s_{22}|^2)|}$$

# u

## Error Limits on Unilateral Gain Calculations

$$\frac{1}{(1+u^2)} < \frac{G_T}{G_{Tu}} < \frac{1}{(1-u^2)}$$

**Unilateral figure of merit**  
All two-port models are bilateral, so both the forward and reverse signal flow must be considered. If the signal flow in the reverse direction is much smaller than the flow in the forward direction, it's possible to make the simplification that the reverse flow is zero.

The unilateral figure of merit is a quick calculation that can be used to determine where this simplification can be made without significantly affecting the accuracy of the model.

# B Scattering Parameter Relationships

Conditions for Absolute Stability :

No passive source or load will cause a network to oscillate, if conditions a, b, and c are all satisfied.

Condition that a two - port network can be simultaneously matched with a real source and load :

$K > 1$  or  $C < 1$  where  $C =$  Linvill C Factor and

$$C = K^{-1}$$

$$K = \frac{1 + |D|^2 - |s_{11}|^2 - |s_{22}|^2}{2|s_{12}s_{21}|}$$

$$a. |s_{11}| < 1, |s_{22}| < 1$$

$$b. \frac{\left| |s_{12}s_{21}| - |M^*| \right|}{\left| |s_{11}|^2 - |D|^2 \right|} > 1$$

$$c. \frac{\left| |s_{12}s_{21}| - |N^*| \right|}{\left| |s_{22}|^2 - |D|^2 \right|} > 1$$

$$D = s_{11}s_{22} - s_{12}s_{21}$$

$$M = s_{11} - Ds_{22}^*$$

$$N = s_{22} - Ds_{11}^*$$

# B Scattering Parameter Relationships

## Source and load for Simultaneous Match

$$\Gamma_{mS} = M^* \left[ \frac{B_1 \pm \sqrt{B_1^2 - 4|M|^2}}{2|M|^2} \right]$$

$$\Gamma_{mL} = N^* \left[ \frac{B_2 \pm \sqrt{B_2^2 - 4|N|^2}}{2|N|^2} \right]$$

(Use minus sign

when  $B_1$  is positive,

plus sign when

$B_1$  is negative.)

$$B_1 = 1 + |s_{11}|^2 - |s_{22}|^2 - |D|^2$$

$$B_2 = 1 + |s_{22}|^2 - |s_{11}|^2 - |D|^2$$

## Maximum Available Power Gain

$$\text{If } K > 1, G_{A \max} = \left| \frac{s_{21}}{s_{12}} \left( K \pm \sqrt{K^2 - 1} \right) \right|$$

where  $K = C^{-1}$



# B Scattering Parameter Relationships

s-parameters in terms of z-parameters	z-parameters in terms of s-parameters
$s_{11} = \frac{(z_{11} - 1)(z_{22} + 1) - z_{12}z_{21}}{(z_{11} + 1)(z_{22} + 1) - z_{12}z_{21}}$	$z_{11} = \frac{(1 + s_{11})(1 - s_{22}) + s_{12}s_{21}}{(1 - s_{11})(1 - s_{22}) - s_{12}s_{21}}$
$s_{12} = \frac{2z_{12}}{(z_{11} + 1)(z_{22} + 1) - z_{12}z_{21}}$	$z_{12} = \frac{2s_{12}}{(1 - s_{11})(1 - s_{22}) - s_{12}s_{21}}$
$s_{21} = \frac{2z_{21}}{(z_{11} + 1)(z_{22} + 1) - z_{12}z_{21}}$	$z_{21} = \frac{2s_{21}}{(1 - s_{11})(1 - s_{22}) - s_{12}s_{21}}$
$s_{22} = \frac{(z_{11} + 1)(z_{22} - 1) - z_{12}z_{21}}{(z_{11} + 1)(z_{22} + 1) - z_{12}z_{21}}$	$z_{22} = \frac{(1 + s_{22})(1 - s_{11}) + s_{12}s_{21}}{(1 - s_{11})(1 - s_{22}) - s_{12}s_{21}}$

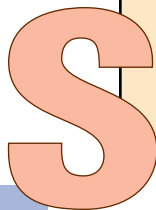

# B Scattering Parameter Relationships

## s-parameters in terms of y-parameters

$$s_{11} = \frac{(1 - y_{11})(1 + y_{22}) + y_{12}y_{21}}{(1 + y_{11})(1 + y_{22}) - y_{12}y_{21}}$$

$$s_{12} = \frac{-2y_{12}}{(1 + y_{11})(1 + y_{22}) - y_{12}y_{21}}$$

$$s_{21} = \frac{-2y_{21}}{(1 + y_{11})(1 + y_{22}) - y_{12}y_{21}}$$

$$s_{22} = \frac{(1 + y_{11})(1 - y_{22}) + y_{12}y_{21}}{(1 + y_{11})(1 + y_{22}) - y_{12}y_{21}}$$

## y-parameters in terms of s-parameters

$$y_{11} = \frac{(1 + s_{22})(1 - s_{11}) + s_{12}s_{21}}{(1 + s_{11})(1 + s_{22}) - s_{12}s_{21}}$$

$$y_{12} = \frac{-2s_{12}}{(1 + s_{11})(1 + s_{22}) - s_{12}s_{21}}$$

$$y_{21} = \frac{-2s_{21}}{(1 + s_{11})(1 + s_{22}) - s_{12}s_{21}}$$

$$y_{22} = \frac{(1 + s_{11})(1 - s_{22}) + s_{12}s_{21}}{(1 + s_{11})(1 + s_{22}) - s_{12}s_{21}}$$

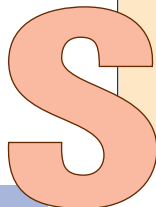
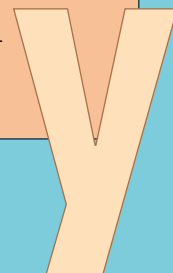
# B Scattering Parameter Relationships

s-parameters in terms of h-parameters	h-parameters in terms of s-parameters
$s_{11} = \frac{(h_{11} - 1)(h_{22} + 1) - h_{12}h_{21}}{(h_{11} + 1)(h_{22} + 1) - h_{12}h_{21}}$	$h_{11} = \frac{(1 + s_{11})(1 + s_{22}) - s_{12}s_{21}}{(1 - s_{11})(1 + s_{22}) + s_{12}s_{21}}$
$s_{12} = \frac{2h_{12}}{(h_{11} + 1)(h_{22} + 1) - h_{12}h_{21}}$	$h_{12} = \frac{2s_{12}}{(1 - s_{11})(1 + s_{22}) + s_{12}s_{21}}$
$s_{21} = \frac{-2h_{21}}{(h_{11} + 1)(h_{22} + 1) - h_{12}h_{21}}$	$h_{21} = \frac{-2s_{21}}{(1 - s_{11})(1 + s_{22}) + s_{12}s_{21}}$
$s_{22} = \frac{(1 + h_{11})(1 - h_{22}) + h_{12}h_{21}}{(h_{11} + 1)(h_{22} + 1) - h_{12}h_{21}}$	$h_{22} = \frac{(1 - s_{22})(1 - s_{11}) - s_{12}s_{21}}{(1 - s_{11})(1 + s_{22}) + s_{12}s_{21}}$

# B Scattering Parameter Relationships

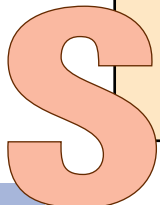
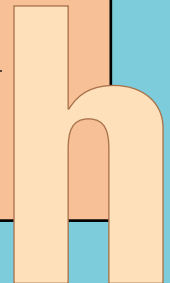
The h-, y-, and z-parameters listed in previous tables are all normalized to  $Z_0$ .  
If  $h'$ ,  $y'$ ,  $z'$  are the actual parameters, then:

$$z'_{11} = z_{11}Z_0$$

$$y'_{11} = y_{11} / Z_0$$

$$h'_{11} = h_{11}Z_0$$

$$z'_{12} = z_{12}Z_0$$

$$y'_{12} = y_{12} / Z_0$$

$$h'_{12} = h_{12}$$

$$z'_{21} = z_{21}Z_0$$

$$y'_{21} = y_{21} / Z_0$$

$$h'_{21} = h_{21}$$

$$z'_{22} = z_{22}Z_0$$

$$y'_{22} = y_{22} / Z_0$$

$$h'_{22} = h_{22} / Z_0$$

**Z<sub>0</sub>**

**Parameter Normalization**  
The various scattering parameters are all normalized by the reference impedance,  $Z_0$ . This impedance is usually the characteristic impedance of the transmission line in which the network of interest is embedded. Normalizing the scattering parameters makes the Smith Chart readily applicable to transmission lines of any impedance. In addition, impedance and admittance values can be plotted on the same chart.

# C CAE tools for High-Frequency Design

## Electronic Design Automation (EDA) The Software Revolution

In the 30 years that have elapsed since the publication of Dick Anderson's article, computer aided engineering (CAE) tools have been developed for the high-frequency design methods that were traditionally implemented using pencil and paper. These computer software programs run on UNIX workstations and PCs, and do much more than merely assist in computation-intensive design tasks.

Modern CAE tools for high-frequency design eliminate the need for simplifying assumptions (such as,  $s_{12} = 0$ ) and can accurately simulate actual device, circuit, or system behavior. They enable broadband solutions, offer optimization and yield-analysis capabilities, and provide answers to "What if?" questions. CAE tools also speed the analysis of a wide range of RF and microwave devices, circuits, and systems, for a shorter time to market, while lowering costs.

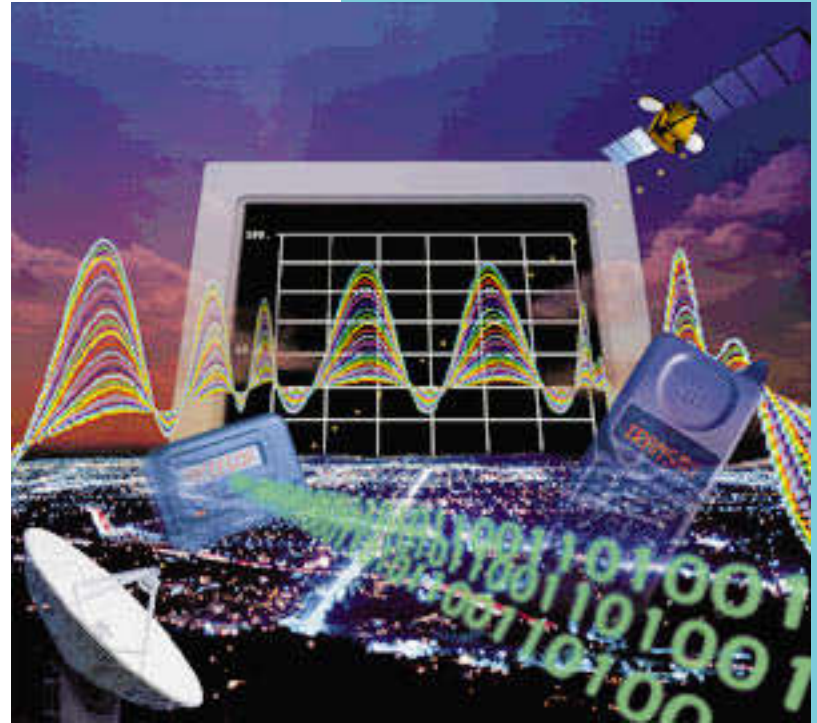

# C CAE tools for High-Frequency Design

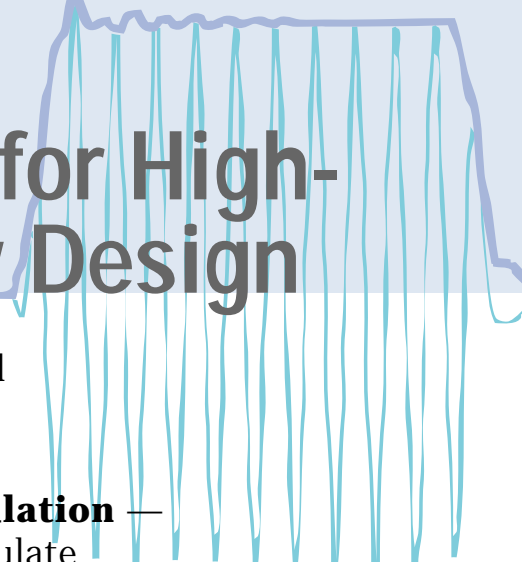

The CAE tools of interest to RF and microwave designers include those summarized below:

## **Small-signal (s-parameter) simulation** —

Small-signal analysis CAE tools simulate response over a range of frequencies, so actual implementations perform more closely to design parameters. Matching circuits are easily determined, and can be readily optimized, saving time. A yield-analysis feature allows the selection of components in matching networks for the best production yield, saving costs.

**Large-signal simulation** — This powerful analysis tool includes the harmonic balance implementation, useful for oscillator design and many other problems.

**Circuit Envelope simulation** — Efficiently analyzes circuits and feedback loops in the presence of modulated or transient high-frequency signals.

## **Circuit Envelope Simulation**

The waveform above typifies the modulated and transient signals that can be efficiently analyzed using circuit envelope simulator software. Circuit envelope simulation is orders of magnitude faster than traditional SPICE simulation software if the envelope bandwidth of the RF carrier frequency is much smaller than the carrier frequency itself. This is the case in many communications, and radar circuits and subsystems.

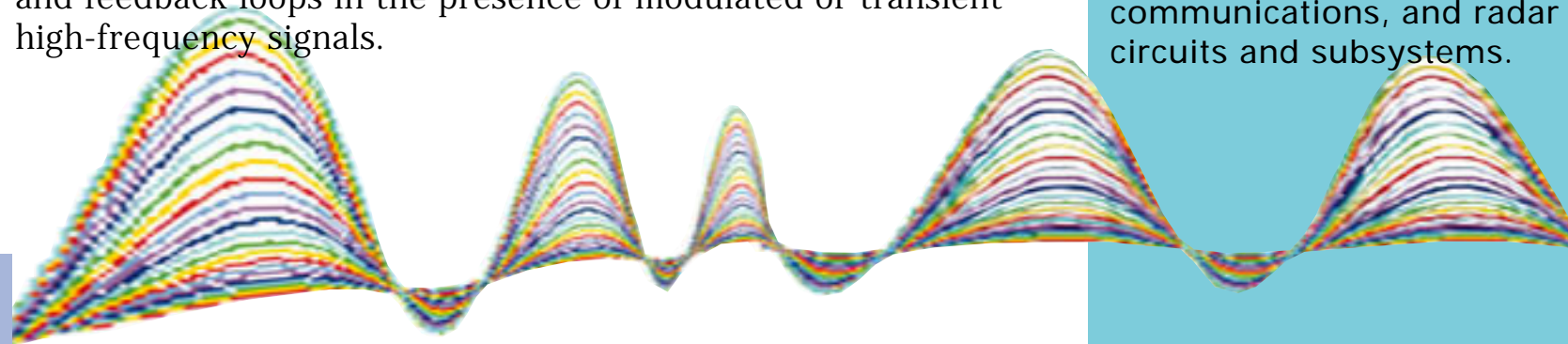

# C CAE tools for High-Frequency Design

**Time-domain analysis** — A CAE tool that is especially useful for simulating the response of digital systems at high clock rates.

**Planar electromagnetic analysis** — This simulator accurately computes the s-, y-, or z-parameters of arbitrarily shaped, multilayer planar structures such as striplines.

**3D electromagnetic analysis** — This CAE tool accurately computes the s-parameters for passive, three-dimensional, multiport structures.

**System analysis** — System and board-level simulators offer discrete-time and frequency-domain capabilities; can analyze and optimize complicated system topologies; handle complex waveforms; and perform physical layout design.

**Modeling systems** — Hardware and software are combined to extract parameters needed for accurate active device modeling.

Visit the HP EEsof website for the latest in CAE news, products, software, and solutions.

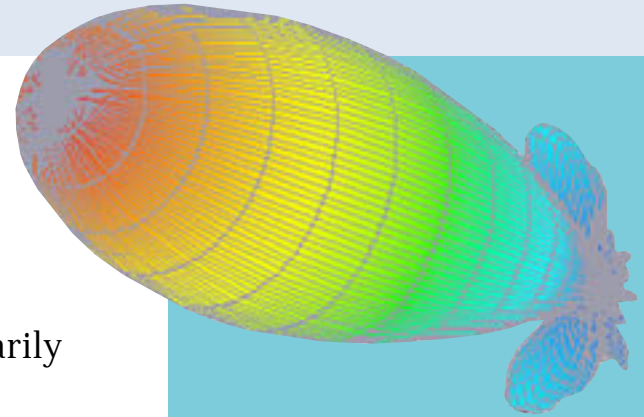

**High Flying Software**  
The pattern of a horn antenna, displayed using HP High-Frequency Structure Simulator 3D electromagnetic visualization software, shows beam shapes in both azimuth and elevation in a single plot.

<http://www.hp.com/go/hpeesof>

# Relevant Products

## HP 8720D Series Vector Network Analyzers

**Vector network analyzers with built-in synthesized sources cover 50 MHz to up to 40 GHz**

The HP 8720D vector network analyzer family characterizes RF and microwave components from 50 MHz up to 40 GHz. They combine a fast synthesized source, tuned receiver, and S-parameter test set in a single instrument. The devices have the performance and flexibility to solve difficult measurement problems and cut test times, all at an attractive cost. Use them to quickly and accurately measure magnitude and phase of all four s-parameters, as well as group delay, plus the absolute output power of microwave components.

Productivity is enhanced with pass/fail testing, direct printer/plotter output of results, advanced marker functions, save/recall of test configurations to internal memory or a built-in floppy disk drive, and test sequencing for automation. Options allow high-power tests, frequency offset mixer testing, and high-accuracy noncoaxial and on-wafer measurements.



### Features of HP 8720D VNA's

- Built-in synthesized source with 1 Hz resolution
- Allows measuring all four s-parameters with a single connection
- Continuous updates for two-port error correction

<http://www.hp.com/go/tmdatasheets>



## **Microwave network analyzers with coverage up to 110 GHz**

The HP 8510C microwave vector network analyzer family provide complete solutions for characterizing the linear behavior of either active or passive networks over the 45 MHz to 110 GHz range. A complete system consists of the HP 8510C network analyzer, an s-parameter test set, and a compatible RF source. Also available are fully integrated systems, tested and verified prior to shipment.

The HP 8510C displays measurement results in log/linear magnitude, phase, or group delay format on a large, color CRT with two independent, yet identical, channels. The impact of systematic errors is removed by virtually “real-time” error correction, so a test device can be adjusted while it’s being measured. Effective directivity and source match can be improved to as much as 60 dB. The HP 85161B software leads the operator one step at a time, from setup and calibration to hardcopy results.

Visit the HP T

# Relevant Products

## HP 8753D RF Network Analyzer

**RF network analyzer with integrated s-parameter test set performs characterizations from 30 kHz to 6 GHz**

The HP 8753D RF vector network analyzer will simplify and speed your device, component, or network measurements in the 30 kHz to 6 GHz range. A 1-Hz resolution swept synthesized source, s-parameter test set, and sensitive receiver are integrated into this compact instrument, which is simple to set up and use in the lab or on the production line. The HP 8753D provides magnitude and phase information, offers up to 110 dB dynamic range, makes group delay and time domain measurements, and uses vector accuracy enhancement to minimize measurement uncertainty.

To increase your throughput in production, the HP 8753D offers features such as the test sequence function, which allows you to make a measurement once from the front panel and automatically save the keystrokes without an external computer. The analyzer's fast CPU clock rate, LIF and DOS formats for output to the built-in disk drive or an external disk drive, and a 512 KB nonvolatile memory also help improve your productivity.



### Features of the HP 8753D

- Built-in s-parameter test set, synthesized source
- Optional time-domain and swept-harmonic measurements
- Up to 110 dB dynamic range
- Superb accuracy, with comprehensive calibration
- Save/recall to built-in disk drive

<http://www.hp.com/go/tmdatasheets>

# Relevant Products

## CAE solutions for RF and microwave design

Time to market is critical to product success in today's competitive environment. CAE tools from Hewlett-Packard's EEsof Division give companies a competitive edge by simplifying and expediting the development of RF and microwave circuits and systems. For cost savings and manufacturing yield improvements, designs can be accurately modeled, simulated, and optimized before they are actually produced.

A comprehensive set of CAE tools from HP EEsof includes high-frequency circuit, electro-magnetic, and system simulators, layout tools, device modeling systems and libraries, and links to instrumentation and third-party design software. Visit the HP EEsof website for a continuously updated list of news, products, software, and solutions.



<http://www.hp.com/go/hpeesof>

# Relevant Products

## HP 85180A High Frequency Structure Simulator

**Fast, accurate electromagnetic simulation of 3D high-frequency structures saves design time**

With today's computer technology, the best method for designing high frequency circuits and machined structures is to compute their behavior with 3D electromagnetic (EM) simulator software, making improvements through successive simulations, then building designs to the refined specifications. This approach is more cost effective and takes less time than building and testing prototype after prototype in the lab.

The HP High Frequency Structure Simulator (HP HFSS), Release 5.0, models arbitrarily-shaped, passive 3D structures such as antennas, machined components, and RF and digital circuits. Using accuracy-driven adaptive solution refinement, the software produces accurate results ten times faster, using half the memory of previous releases. Its drawing environment and parts library simplify specifying complex structures. For comprehensive evaluations, animated EM fields, surface currents, vector plots, antenna polar patterns and tabular, generalized s-parameters and Smith charts can be viewed.

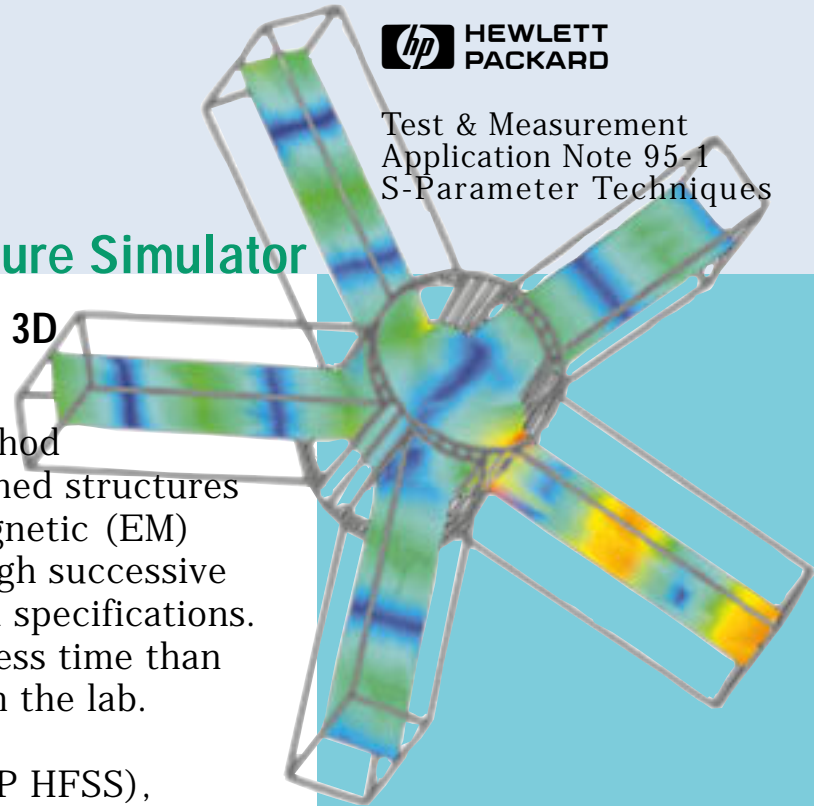

### Features of the HP 85180A

- Reduces "cut and try" prototyping, for lower development costs and a quicker time to market
- Yields accurate results ten times faster, using half the memory of previous releases
- Requires minimal user knowledge of EM field theory
- For PC and UNIX platforms

<http://www.hp.com/go/hpeesof>

# Relevant Services

## RF and microwave education and training

HP offers an extensive curriculum of education services at locations worldwide. To help high-frequency design engineers learn how to use CAE tools quickly, we provide training courses taught by the experts from HP's EEs of Division. Advanced RF/microwave CAE courses are also conducted to help extend the capabilities and hone the skills of experienced CAE users.



HP education classes are scheduled regularly. The curriculum can be tailored to a company's special needs, and training sessions can be conducted at its site.

Visit HP's World Wide Website for the complete and continuously updated list of Test & Measurement class schedules and locations around the world. Click on the URL below or type the address in your browser. Register directly online!



<http://www.hp.com/go/tmeducation>

# Worldwide Contacts

## Hewlett-Packard Test & Measurement offices

### Asia-Pacific

Hewlett-Packard Asia Pacific Ltd.  
Hewlett-Packard Hong Kong Ltd.  
17-21/F Shell Tower, Times Square  
1 Matheson Street, Causeway Bay  
Hong Kong  
**85 2 599 7777**

For Japan: **0120-421-345**

### Australia/New Zealand

Hewlett-Packard Australia Ltd.  
31-41 Joseph Street  
Blackburn, Victoria 3130  
Australia  
**1 800 627 485**

### Canada

Hewlett-Packard Ltd.  
5150 Spectrum Way  
Mississauga, Ontario L4W 5G1  
**905 206 4725**

### Europe/Middle East/Africa

Hewlett-Packard S.A.  
150, Route du Nant-d'Avril  
1217 Meyrin 1  
Geneva, Switzerland

For Europe:  
**41 22 780 81 11**

For Middle East/Africa:  
**41 22 780 41 11**

### Latin America

Latin American Region  
Headquarters  
Hewlett-Packard Company  
Waterford Building, Suite 950  
5200 Blue Lagoon  
Miami, FL 33126  
**305-267-4245**

### United States of America

Hewlett-Packard Company  
**800-452-4844**

Visit HP's World Wide Website for the complete and up to date listing of Test & Measurement sales office addresses and call center phone numbers. Click on the URL below or type the address in your browser.

<http://www.hp.com/go/tmdir>



# Copyrights and Credits

## Authors, contributors and producers

### Authors

**Dick Anderson** – original author of this application note.

**Lee Smith** – S-parameter guru, mathematical programming, technical illustrations, updated & revised content, and animations.

**Jeff Gruszynski** – expert domain consultant, content perspectives, side-bars text, and source images.

### Contributors

**Walt Patstone** – technical content and side-bar editing.

**Chuck McGuire, Mike**

**C'debaca** – new s-parameter measurements & device output.

### Graphic & Interaction Design

**Ev Shafrir** – original concept, art direction, interaction design, digital publishing & production, content supervision, overall direction, & project management.

**Christina Bangle** – free-style illustrations and graphic reviews.

**Kathy Cunningham** – page layout design and Quark guru.

**Leann Scully** – source images.

### Business Manager

**Nyna Casey** – funding, support, excitement, and encouragement.



### Richard W. Anderson

Holds a 1959 BSEE degree from Utah State University and a 1963 MSEE degree from Stanford University. During his 37 years with HP Dick has contributed to the development of numerous microwave and other T&M instruments. Currently, he is HP Vice President, and General Manager of the T&M Microwave and Communications Group.

© Copyright Hewlett-Packard Company 1996-1997 All Rights Reserved. Adaptation, reproduction, translation, extraction, dissemination or disassembly without prior written permission is prohibited except as allowed under the copyright laws. S-Parameter Techniques for Faster, More Accurate Network Design is electronically published as part of the HP Test & Measurement Digital Application Note Library for the World Wide Web, November 1996. Original printed publication Number 5952-1130.