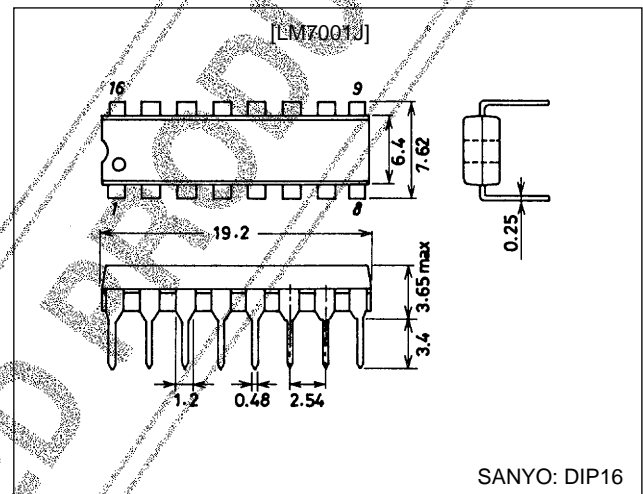

SANYO**LM7001J, 7001JM****Direct PLL Frequency Synthesizers
for Electronic Tuning****Features**

- The LM7001J and LM7001JM are PLL frequency synthesizer LSIs for tuners, making it possible to make up high-performance AM/FM tuners easily.
- These LSIs are software compatible with the LM7000, but do not include an IF calculation circuit.
- The FM VCO circuit includes a high-speed programmable divider that can divide directly.
- Seven reference frequencies: 1, 5, 9, 10, 25, 50, and 100 kHz
- Band-switching outputs (3 bits)
- Controller clock output (400 kHz)
- Clock time base output (8 Hz)
- Serial input circuit for data input (using the CE, CL, and DATA pins)

Package Dimensions

unit: mm

3006B-DIP16

unit: mm

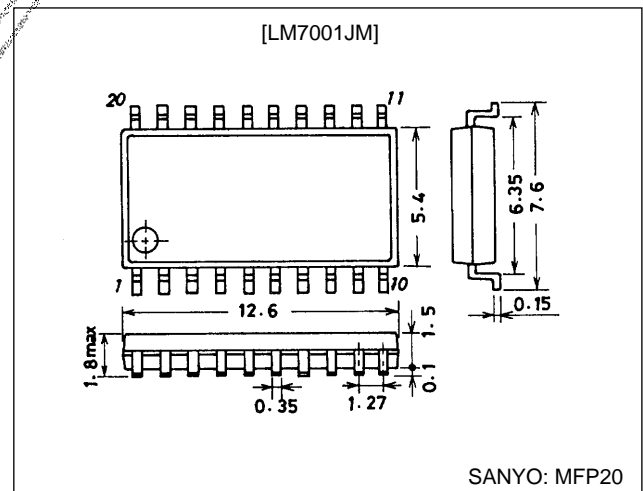
3036B-MFP20

LM7001J, 7001JM

Pin Assignments

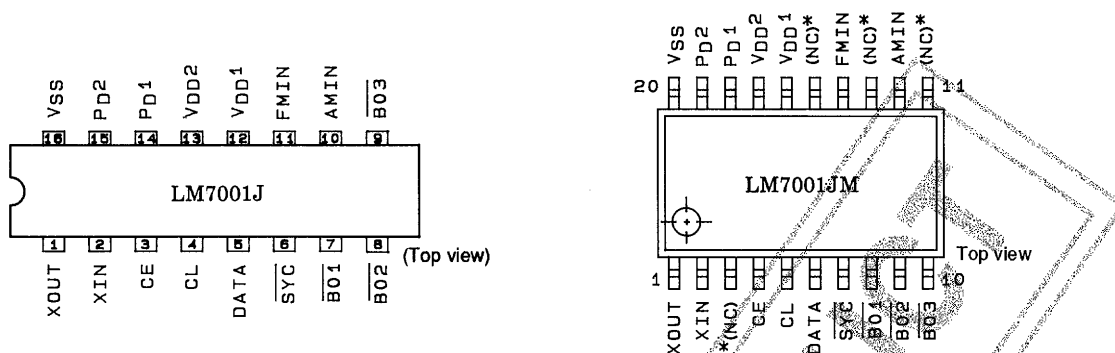

Note: * NC pins must be left open.

Specifications

Absolute Maximum Ratings at $T_a = 25^\circ\text{C}$, $V_{SS} = 0\text{ V}$

Parameter	Symbol	Conditions	Ratings	Unit
Maximum supply voltage	$V_{DD\text{ max}}$	V_{DD1}, V_{DD2}	-0.3 to +7.0	V
Maximum input voltage	$V_{IN1\text{ max}}$	CE, CL, DATA	-0.3 to +7.0	V
	$V_{IN2\text{ max}}$	Input pins other than V_{IN1}	-0.3 to $V_{DD} + 0.3$	V
Maximum output voltage	$V_{OUT1\text{ max}}$	SYNC	-0.3 to +7.0	V
	$V_{OUT2\text{ max}}$	BO1 to BO3	-0.3 to +13	V
	$V_{OUT3\text{ max}}$	Output pins other than V_{OUT1} and V_{OUT2}	-0.3 to $V_{DD} + 0.3$	V
Maximum output current	$I_{OUT\text{ max}}$	BO1 to BO3	0 to 3.0	mA
Allowable power dissipation	$P_d\text{ max}$	$T_a = 85^\circ\text{C}$, LM7001J (DIP16)	300	mW
		$T_a = 85^\circ\text{C}$, LM7001JM (MFP20)	180	mW
Operating temperature	T_{opr}		-40 to +85	$^\circ\text{C}$
Storage temperature	T_{stg}		-55 to +125	$^\circ\text{C}$

Allowable Operating Ranges at $T_a = -40$ to $+85^\circ\text{C}$, $V_{SS} = 0\text{ V}$

Parameter	Symbol	Conditions	Ratings	Unit
Supply voltage	V_{DD1}	V_{DD1} , PLL circuit operating	4.5 to 6.5	V
	V_{DD2}	V_{DD2} , crystal oscillator time base	3.5 to 6.5	V
Input high-level voltage	V_{IH}	CE, CL, DATA	2.2 to 6.5	V
Input low-level voltage	V_{IL}	CE, CL, DATA	0 to 0.7	V
Output voltage	V_{OUT1}	SYNC	0 to 6.5	V
	V_{OUT2}	BO1 to BO3	0 to 13	V
Output current	I_{OUT}	BO1 to BO3, $V_{DD} = 4.5$ to 6.5 V	0 to 3.0	mA
Input frequency	f_{IN1}	XIN, sine wave, capacitor coupled	1.0 to 7.2 typ to 8.0	MHz
	f_{IN2}	FMIN, sine wave, capacitor coupled*1, $s^{*3} = 1$	45 to 130	MHz
	f_{IN3}	FMIN, sine wave, capacitor coupled*2, $s^{*3} = 1$	5 to 30	MHz
	f_{IN4}	AMIN, sine wave, capacitor coupled, $s^{*3} = 0$	0.5 to 10	MHz
Crystal element for guaranteed oscillation	Xtal	XIN to XOUT, $C_i \leq 30\ \Omega$	5.0 to 7.2 typ to 8.0	MHz
Input amplitude	V_{IN1}	XIN, sine wave, capacitor coupled	0.5 to 1.5	Vrms
	V_{IN2}	FMIN, sine wave, capacitor coupled	0.1 to 1.5	Vrms
	V_{IN3}	AMIN, sine wave, capacitor coupled	0.1 to 1.5	Vrms

Note: 1. $f_{ref} = 25, 50,$ or 100 kHz .
 2. f_{ref} = Reference frequencies other than those for *1.
 3. "s" refers to the control bit in the serial data.

Electrical Characteristics in the Allowable Operating Ranges

Parameter	Symbol	Conditions	min	typ	max	Unit
Built-in feedback resistance	R_{f1}	XIN		1.0		M Ω
	R_{f2}	FMIN		500		k Ω
	R_{f3}	AMIN		500		k Ω
Input high-level current	I_{IH}	CE, CL, DATA: $V_{IN} = 6.5$ V			5.0	μ A
Input low-level current	I_{IL}	CE, CL, DATA: $V_{IN} = 0$ V			5.0	μ A
Output low-level voltage	V_{OL1}	FMIN, AMIN: $I_{OUT} = 0.5$ mA			3.5	V
	V_{OL2}	SYC: $I_{OUT} = 0.1$ mA, *1	0.02		0.3	V
	V_{OL3}	BO1 to BO3: $I_{OUT} = 2.0$ mA			1.0	V
	V_{OL4}	P_{D1}, P_{D2} : $I_{OUT} = 0.1$ mA			0.3	V
Output off leakage current	I_{OFF1}	SYC: $V_{OUT} = 6.5$ V			5.0	μ A
	I_{OFF2}	BO1 to BO3: $V_{OUT} = 13$ V			3.0	μ A
Output high-level voltage	V_{OH}	P_{D1}, P_{D2} : $I_{OUT} = -0.1$ mA	$0.5 V_{DD}$			V
High-level 3-state off leakage current	I_{OFFH}	P_{D1}, P_{D2} : $V_{OUT} = V_{DD}$		0.01	10.0	nA
Low-level 3-state off leakage current	I_{OFFL}	P_{D1}, P_{D2} : $V_{OUT} = 0$ V		0.01	10.0	nA
Current drain	I_{DD1}	$V_{DD1} + V_{DD2}$: *2		25	40	mA
	I_{DD2}	V_{DD2} : PLL block stopped		2.0	3.5	mA
Input capacitance	C_{IN}	FMIN	1	2	3	pF

Note: 1. $V_{DD} = 3.5$ to 6.5 V

2. With a 7.2 MHz crystal connected between XIN and XOUT, $f_{IN2} = 130$ MHz, $V_{IN2} = 100$ mVrms, other input pins at V_{SS} , output pins open.

Oscillator Circuit Example

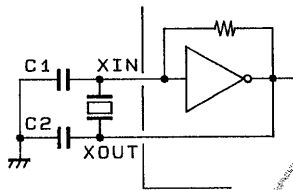

A04895

Kinseki, Ltd.

HC43/U: 2114-84521 (1): $C_L = 10$ pF, $C_1 = 15$ (10 to 22) pF, $C_2 = 15$ pF

HC43/U: 2114-84521 (2): $C_L = 16$ pF, $C_1 = 22$ (15 to 33) pF, $C_2 = 33$ pF

Nihon Denpa Kogyo, Ltd.

NR-18: LM-X-0701: $C_L = 10$ pF, $C_1 = 15$ pF, $C_2 = 15$ pF

Since the circuit constants in the crystal oscillator circuit depend on the crystal element used and the printed circuit board pattern, we recommend consulting with the manufacturer of the crystal element concerning this circuit.

Equivalent Circuit Block Diagram

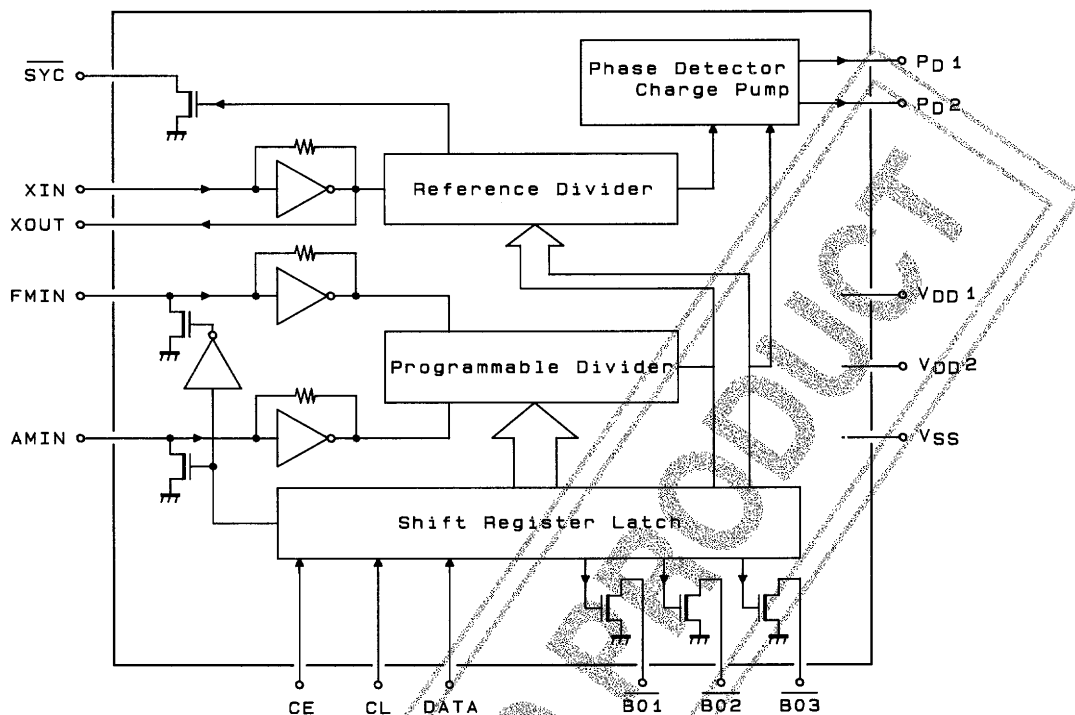

Pin Functions

Symbol	Description
$\overline{\text{SYC}}$	Controller clock (400 kHz)
XIN, XOUT	Crystal oscillator (7.2 MHz)
FMIN, AMIN	Local oscillator signal input
CE, CL, DATA	Data input
$\overline{\text{B01}}$ to $\overline{\text{B03}}$	Band data output. $\overline{\text{B01}}$ can be used as a time base output (8 Hz).
V_{DD1} , V_{DD2} , V_{SS}	Power supply (Apply power to both V_{DD1} and V_{DD2} when the PLL circuit is operating. V_{DD2} is the crystal oscillator and time base power supply. Internal data cannot be maintained on V_{DD2} only.)
P_{D1} , P_{D2}	Charge pump output

LM7001J, 7001JM

Data Input Timing

$V_{IH} = 2.2$ to 6.5 V, $V_{IL} = 0$ to 0.7 V, $Xtal = 5.00$ to 7.20 (typ) to 8.00 MHz

Data acquisition: On the CL rising edge ↗

Note: Data transfers must be started only after the crystal oscillator is operating normally, i.e., after a proper input signal has been supplied to XIN.

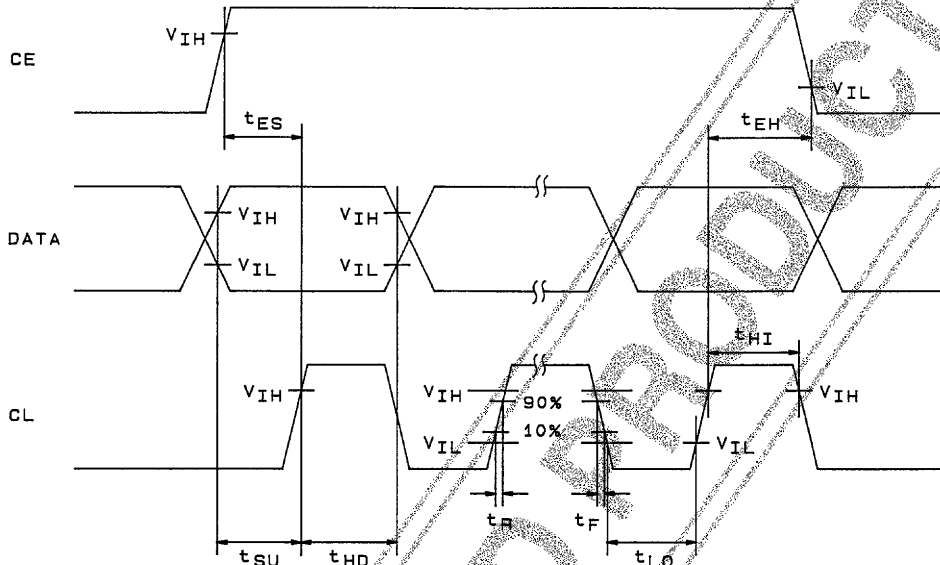

A04896

Parameter	Symbol	Xtal: 7.20 MHz	Xtal: for frequencies other than 7.2 MHz	Example: XIN = 2.048 MHz
Enable setup time	t_{ES}	At least $1.5 \mu\text{s}$	At least $\left[\frac{1 \times 8}{f_{Xtal}} \right] \times 1.35$	At least $5.27 \mu\text{s}$
Enable hold time	t_{EH}	At least $1.5 \mu\text{s}$	At least $\left[\frac{1 \times 8}{f_{Xtal}} \right] \times 1.35$	At least $5.27 \mu\text{s}$
Data setup time	t_{SU}	At least $1.5 \mu\text{s}$	At least $\left[\frac{1 \times 8}{f_{Xtal}} \right] \times 1.35$	At least $5.27 \mu\text{s}$
Data hold time	t_{HD}	At least $1.5 \mu\text{s}$	At least $\left[\frac{1 \times 8}{f_{Xtal}} \right] \times 1.35$	At least $5.27 \mu\text{s}$
Clock low-level time	t_{LO}	At least $1.5 \mu\text{s}$	At least $\left[\frac{1 \times 8}{f_{Xtal}} \right] \times 1.35$	At least $5.27 \mu\text{s}$
Clock high-level time	t_{HI}	At least $1.5 \mu\text{s}$	At least $\left[\frac{1 \times 8}{f_{Xtal}} \right] \times 1.35$	At least $5.27 \mu\text{s}$
Rise time	t_R	Up to $1 \mu\text{s}$	Up to $1 \mu\text{s}$	Up to $1 \mu\text{s}$
Fall time	t_F	Up to $1 \mu\text{s}$	Up to $1 \mu\text{s}$	Up to $1 \mu\text{s}$

Data Input

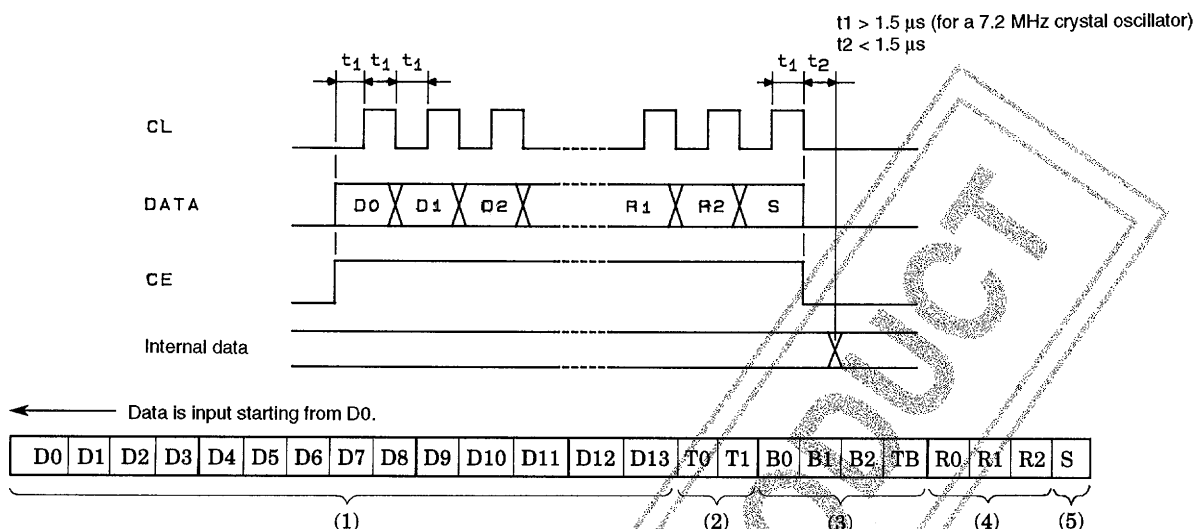

- (1) D0 (LSB) to D13 (MSB): Divisor data
 FMIN uses D0 to D13 and AMIN uses D4 to D13.

D0	D1	D2	D3	D4	D5	D6	D7	D8	D9	D10	D11	D12	D13	→ Example ①: FMIN divisor = 1007
1	1	1	1	0	1	1	1	1	1	0	0	0	0	
LSB													MSB	
X	X	X	X	1	0	0	0	1	0	0	1	0	0	→ Example ②: AMIN divisor = 145
LSB				MSB										

Sample calculation

- ① FM 100 kHz steps ($f_{ref} = 100 \text{ kHz}$)
 FM VCO = 100.7 MHz (FM RF = 90.0 MHz, IF = 10.7 MHz)
 Divisor = $100.7 \text{ MHz (FM VCO)} \div 100 \text{ kHz (} f_{ref}) = 1007 \rightarrow 3EF_{(HEX)}$
- ② AM 10 kHz steps ($f_{ref} = 10 \text{ kHz}$)
 AM VCO = 1450 kHz (AM RF = 1000 kHz, IF = 450 kHz)
 Divisor = $1450 \text{ kHz (AM VCO)} \div 10 \text{ kHz (} f_{ref}) = 145 \rightarrow 91_{(HEX)}$

- (2) T0 and T1 are LSI test bits and both should be set to 0.

- (3) B0 to B2, TB: Band data
 Time base data

Note: *: Determined by R0 to R3. See item (4) on next page.

Input				Output		
B0	B1	B2	TB	BO1	BO2	BO3
0	0	0	0	*	*	*
0	0	1	0	0	0	1
0	1	0	0	0	1	0
0	1	1	0	0	1	1
1	0	0	0	1	0	0
1	0	1	0	1	0	1
1	1	0	0	1	1	0
1	1	1	0	1	1	1
0	0	0	1	TB	*	*
X	1	0	1	TB	1	0
X	0	1	1	TB	0	1
X	1	1	1	TB	1	1
1	0	0	1	TB	0	0

X: Don't care
 TB: 8 Hz

(4) R0 to R2: Reference frequency data

R0	R1	R2	f _{ref} [kHz]	$\overline{BO1}$	$\overline{BO2}$	$\overline{BO3}$
0	0	0	100	1	1	0
0	0	1	50	1	1	0
0	1	0	25	1	1	0
0	1	1	5	0	0	1
1	0	0	10	1	0	1
1	0	1	9	1	0	1
1	1	0	1	0	1	1
1	1	1	5	0	0	1

Note: The values listed for $\overline{BO1}$, $\overline{BO2}$, and $\overline{BO3}$ are for the case when the B0 to B2 data is set to all zeros.

(5) S: Divider selection data

1: FMIN, 0: AMIN

Notes on PLL IC Usage

1. PLL IC printed circuit board patterns

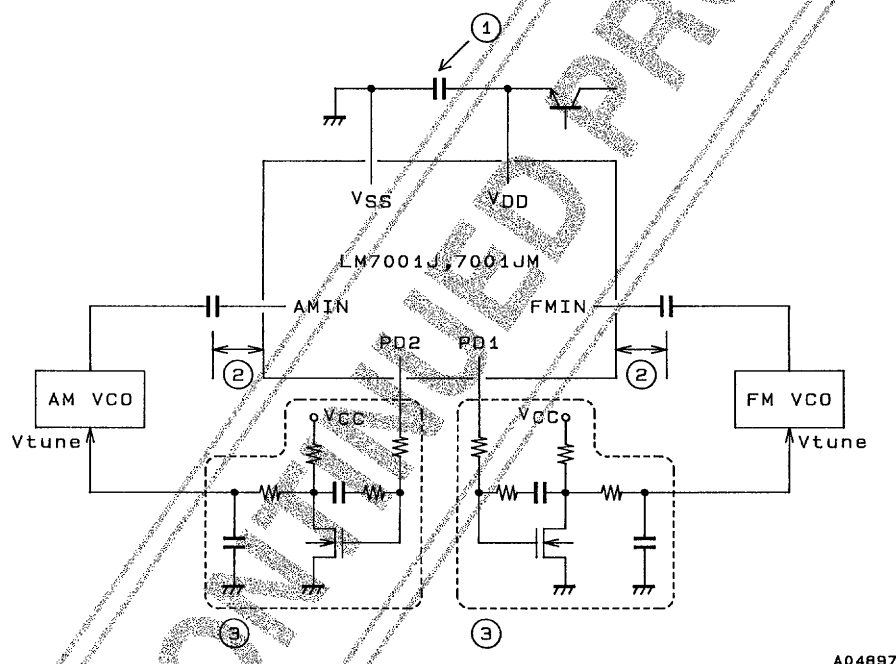

A04897

① Power supply pins

A capacitor must be inserted between the V_{DD} and V_{SS} power supply pins for noise exclusion. This capacitor must be located as close as possible to these pins.

② FMIN and AMIN pins

The coupling capacitors must be located as close as possible to these pins.

③ PD pins, low-pass filter

Since those are high-impedance pins, they are susceptible to noise. Therefore, the pattern should be kept as short as possible and the area around this circuit should be covered by the ground pattern.

2. Initial states of the output ports ($\overline{BO1}$ to $\overline{BO3}$)

The initial states of the output ports after power is applied are undefined until data has been transferred.

In particular, it is possible for the $\overline{BO1}$ and $\overline{BO3}$ pins to output the internal clock, so data must be transferred as soon as possible.

However, note that the LSI cannot accept data until the crystal oscillator is operating normally.

3. VCO

The VCO circuit is designed so that it does not stop oscillating even if the control voltage (V_{tune}) becomes 0 V. (This is because the PLL circuit could become deadlocked if the VCO stopped.)

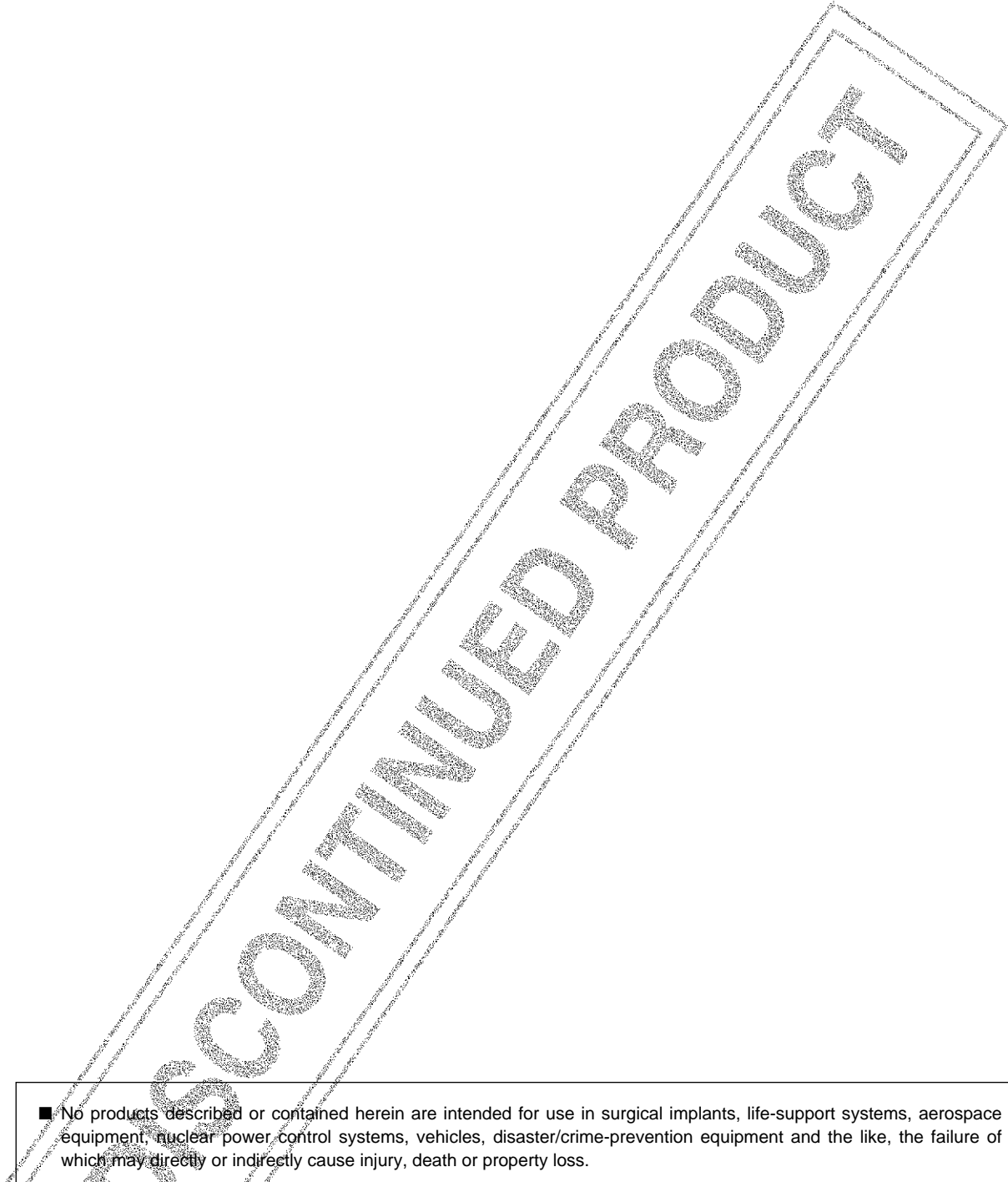
- 
- No products described or contained herein are intended for use in surgical implants, life-support systems, aerospace equipment, nuclear power control systems, vehicles, disaster/crime-prevention equipment and the like, the failure of which may directly or indirectly cause injury, death or property loss.
 - Anyone purchasing any products described or contained herein for an above-mentioned use shall:
 - ① Accept full responsibility and indemnify and defend SANYO ELECTRIC CO., LTD., its affiliates, subsidiaries and distributors and all their officers and employees, jointly and severally, against any and all claims and litigation and all damages, cost and expenses associated with such use:
 - ② Not impose any responsibility for any fault or negligence which may be cited in any such claim or litigation on SANYO ELECTRIC CO., LTD., its affiliates, subsidiaries and distributors or any of their officers and employees jointly or severally.
 - Information (including circuit diagrams and circuit parameters) herein is for example only; it is not guaranteed for volume production. SANYO believes information herein is accurate and reliable, but no guarantees are made or implied regarding its use or any infringements of intellectual property rights or other rights of third parties.

This catalog provides information as of February, 1997. Specifications and information herein are subject to change without notice.