

Power management (dual digital transistors)

UMC2N / FMC2A

●Features

- 1) Includes a DTA124E and a DTC124E transistor in a single UMT and a SMT package.
- 2) Ideal for power switch circuits.
- 3) Mounting cost and area can be cut in half.

●Structure

A PNP and a NPN digital transistor (each with two built in resistors)

The following characteristics apply to both the DTr₁ and DTr₂, however, the “-” sign on DTr₂ values for the PNP type have been omitted.

●External dimensions (Units: mm)

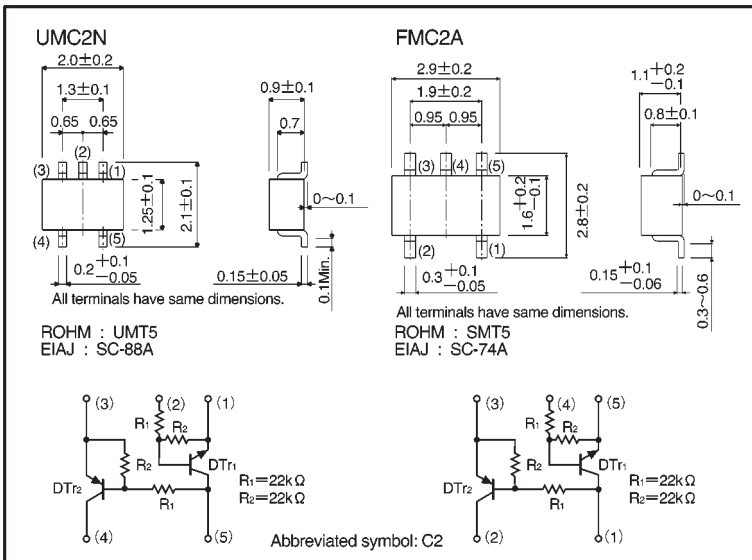

●Absolute maximum ratings (Ta = 25°C)

Parameter	Symbol	Limits	Unit
Supply voltage	V _{CC}	50	V
Input current	V _{IN}	40	V
		-10	
Output current	I _o	30	mA
	I _{C(Max.)}	100	
Power dissipation	UMC2N	150 (TOTAL)	mW
	FMC2A	300 (TOTAL)	
Junction temperature	T _J	150	°C
Storage temperature	T _{stg}	-55 ~ +150	°C

*1 120mW per element must not be exceeded.

*2 200mW per element must not be exceeded.

●Electrical characteristics (Ta = 25°C)

Parameter	Symbol	Min.	Typ.	Max.	Unit	Conditions
Input voltage	$V_{I(off)}$	—	—	0.5	V	$V_{CC}=5V, I_o=100\mu A$
	$V_{I(on)}$	3	—	—		$V_o=0.2V, I_o=5mA$
Output voltage	$V_{O(on)}$	—	0.1	0.3	V	$I_o/I_i=10mA/0.5mA$
Input current	I_i	—	—	0.36	mA	$V_i=5V$
Output current	$I_{O(off)}$	—	—	0.5	μA	$V_{CC}=50V, V_i=0V$
DC current gain	G_i	56	—	—	—	$V_o=5V, I_o=5mA$
Transition frequency	f_T	—	250	—	MHz	$V_{CE}=10mA, I_E=-5mA, f=100MHz$ *
Input resistance	R_1	15.4	22	28.6	k Ω	—
Resistance ratio	R_2/R_1	0.8	1	1.2	—	—

* Transition frequency of the device

●Packaging specifications

Part No.	Packaging type	Taping	
	Code	TR	T148
	Basic ordering unit (pieces)	3000	3000
UMC2N		○	—
FMC2A		—	○

●Electrical characteristic curves

DT_{r1}

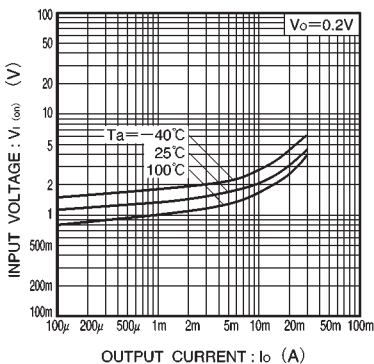

Fig.1 Input voltage vs. output current (ON characteristics)

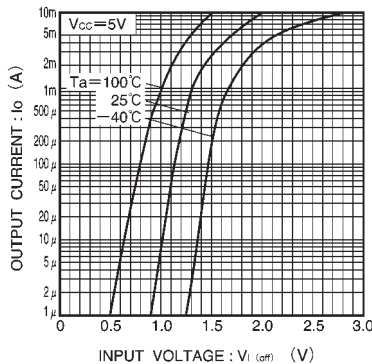

Fig.2 Output current vs. input voltage (OFF characteristics)

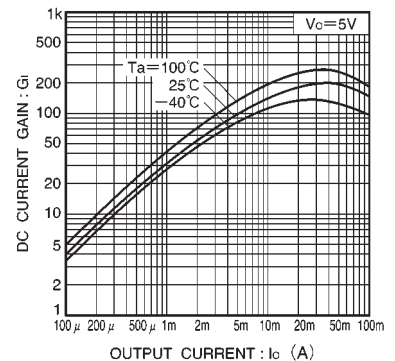

Fig.3 DC current gain vs. output current

DT_{r2}

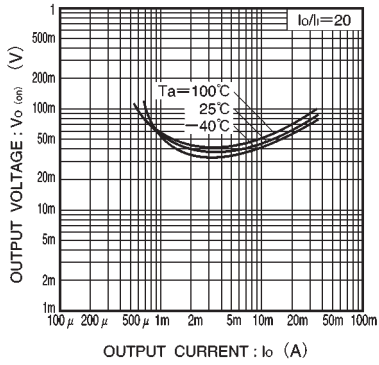

Fig.4 Output voltage vs. output current

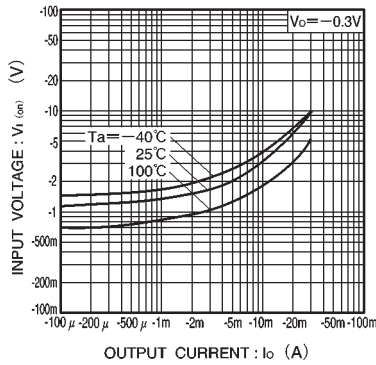

Fig.5 Input voltage vs. output current (ON characteristics)

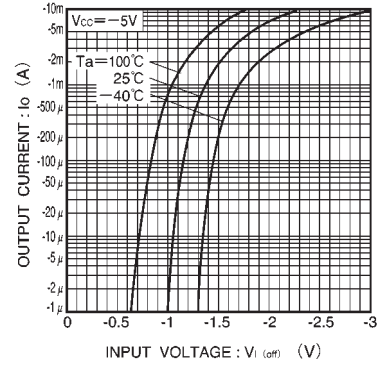

Fig.6 Output current vs. input voltage (OFF characteristics)

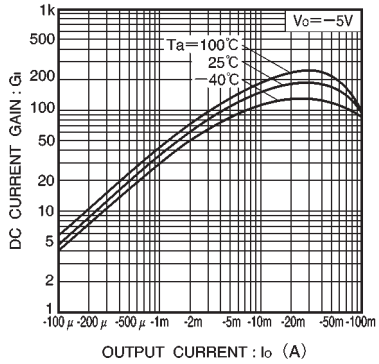

Fig.7 DC current gain vs. output current

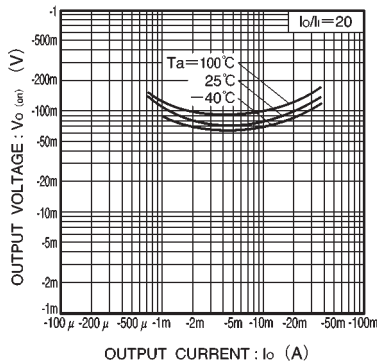

Fig.8 Output voltage vs. output current