

Universal LED, \varnothing 1.8 mm Tinted Diffused Miniplast Package

Color	Type	Technology	Angle of Half Intensity $\pm\varphi$
Red	TLUR240.	GaAsP on GaAs	20°
Orange red	TLUO240.	GaAsP on GaP	
Yellow	TLUY240.	GaAsP on GaP	
Green	TLUG240.	GaP on GaP	

Features

- Four colors
- For DC and pulse operation
- Luminous intensity categorized
- End-to-end stackable in centre-to-centre spacing of 0.1" (2.54 mm)

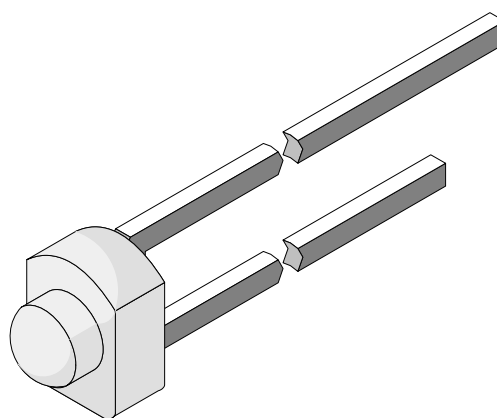

Applications

General indicating and lighting purposes

94 8639

Absolute Maximum Ratings

$T_{amb} = 25^{\circ}\text{C}$, unless otherwise specified

TLUR240. ,TLUO240. ,TLUY240. ,TLUG240.

Parameter	Test Conditions	Type	Symbol	Value	Unit
Reverse voltage			V_R	6	V
DC forward current		TLUR240.	I_F	50	mA
		TLUO240.	I_F	30	mA
		TLUY240.	I_F	30	mA
		TLUG240.	I_F	30	mA
Surge forward current	$t_p \leq 10 \mu\text{s}$		I_{FSM}	1	A
Power dissipation	$T_{amb} \leq 55^{\circ}\text{C}$		P_V	100	mW
Junction temperature			T_j	100	$^{\circ}\text{C}$
Storage temperature range			T_{stg}	-55 to +100	$^{\circ}\text{C}$
Soldering temperature	$t \leq 3 \text{ s}$, 2 mm from body		T_{sd}	260	$^{\circ}\text{C}$
	$t \leq 5 \text{ s}$, 4 mm from body		T_{sd}	260	$^{\circ}\text{C}$
Thermal resistance junction/ambient			R_{thJA}	450	K/W

TLU.240.

Optical and Electrical Characteristics

$T_{amb} = 25^{\circ}\text{C}$, unless otherwise specified

Red (TLUR240.)

Parameter	Test Conditions	Type	Symbol	Min	Typ	Max	Unit
Luminous intensity	$I_F = 10 \text{ mA}$, $I_{Vmin}/I_{Vmax} \geq 0.5$	TLUR2400	I_V	0.4	0.8		mcd
		TLUR2401	I_V	1	1.5	5	mcd
Dominant wavelength	$I_F = 10 \text{ mA}$		λ_d		645		nm
Peak wavelength	$I_F = 10 \text{ mA}$		λ_p		660		nm
Angle of half intensity	$I_F = 10 \text{ mA}$		φ		± 20		deg
Forward voltage	$I_F = 20 \text{ mA}$		V_F		1.6	2	V
Reverse voltage	$I_R = 10 \mu\text{A}$		V_R	6	15		V
Junction capacitance	$V_R = 0$, $f = 1 \text{ MHz}$		C_j		50		pF

Orange red (TLUO240.)

Parameter	Test Conditions	Type	Symbol	Min	Typ	Max	Unit
Luminous intensity	$I_F = 10 \text{ mA}$, $I_{Vmin}/I_{Vmax} \geq 0.5$	TLUO2400	I_V	1.6	2		mcd
		TLUO2401	I_V	4	5	20	mcd
Dominant wavelength	$I_F = 10 \text{ mA}$		λ_d	612		625	nm
Peak wavelength	$I_F = 10 \text{ mA}$		λ_p		630		nm
Angle of half intensity	$I_F = 10 \text{ mA}$		φ		± 20		deg
Forward voltage	$I_F = 20 \text{ mA}$		V_F		2	3	V
Reverse voltage	$I_R = 10 \mu\text{A}$		V_R	6	15		V
Junction capacitance	$V_R = 0$, $f = 1 \text{ MHz}$		C_j		50		pF

Yellow (TLUY240.)

Parameter	Test Conditions	Type	Symbol	Min	Typ	Max	Unit
Luminous intensity	$I_F = 10 \text{ mA}$, $I_{Vmin}/I_{Vmax} \geq 0.5$	TLUY2400	I_V	1	4		mcd
		TLUY2401	I_V	2.5	8	12.5	mcd
Dominant wavelength	$I_F = 10 \text{ mA}$		λ_d	581		594	nm
Peak wavelength	$I_F = 10 \text{ mA}$		λ_p		585		nm
Angle of half intensity	$I_F = 10 \text{ mA}$		φ		± 20		deg
Forward voltage	$I_F = 20 \text{ mA}$		V_F		2.4	3	V
Reverse voltage	$I_R = 10 \mu\text{A}$		V_R	6	15		V
Junction capacitance	$V_R = 0$, $f = 1 \text{ MHz}$		C_j		50		pF

Green (TLUG240.)

Parameter	Test Conditions	Type	Symbol	Min	Typ	Max	Unit
Luminous intensity	$I_F = 10 \text{ mA}$, $I_{Vmin}/I_{Vmax} \geq 0.5$	TLUG2400	I_V	1.6	5		mcd
		TLUG2401	I_V	4	12	20	mcd
Dominant wavelength	$I_F = 10 \text{ mA}$		λ_d	562		575	nm
Peak wavelength	$I_F = 10 \text{ mA}$		λ_p		565		nm
Angle of half intensity	$I_F = 10 \text{ mA}$		φ		± 20		deg
Forward voltage	$I_F = 20 \text{ mA}$		V_F		2.4	3	V
Reverse voltage	$I_R = 10 \mu\text{A}$		V_R	6	15		V
Junction capacitance	$V_R = 0$, $f = 1 \text{ MHz}$		C_j		50		pF

Typical Characteristics ($T_{amb} = 25^{\circ}\text{C}$, unless otherwise specified)

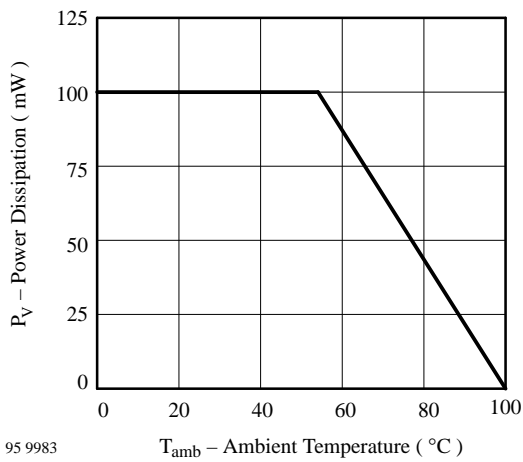

Figure 1. Power Dissipation vs. Ambient Temperature

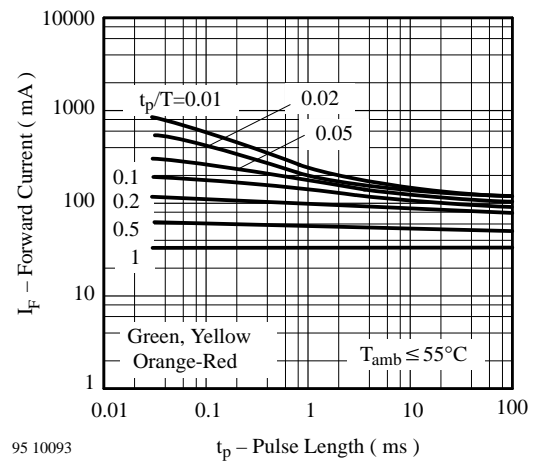

Figure 4. Forward Current vs. Pulse Length

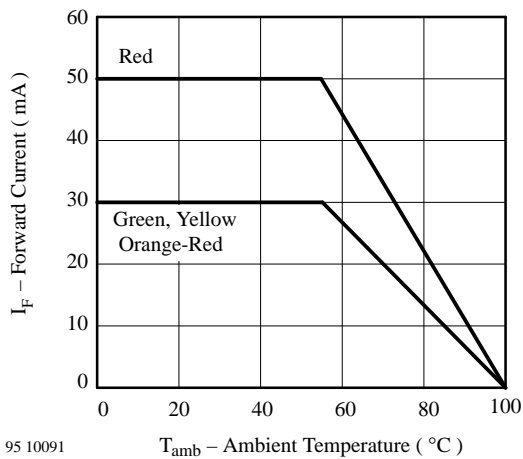

Figure 2. Forward Current vs. Ambient Temperature

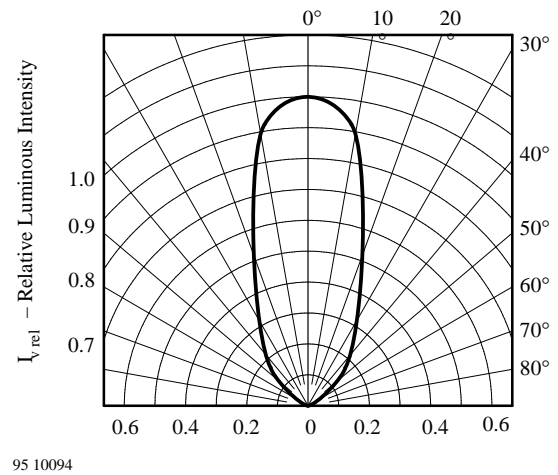

Figure 5. Rel. Luminous Intensity vs. Angular Displacement

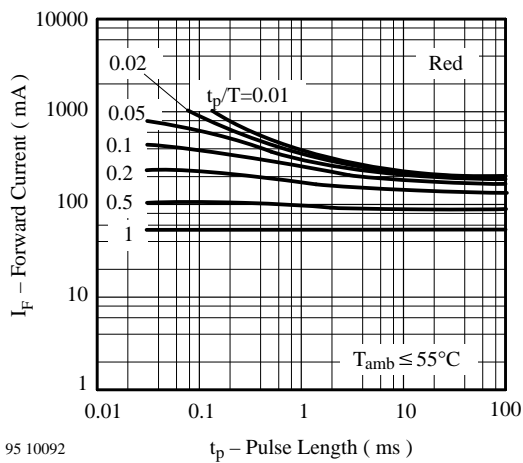

Figure 3. Forward Current vs. Pulse Length

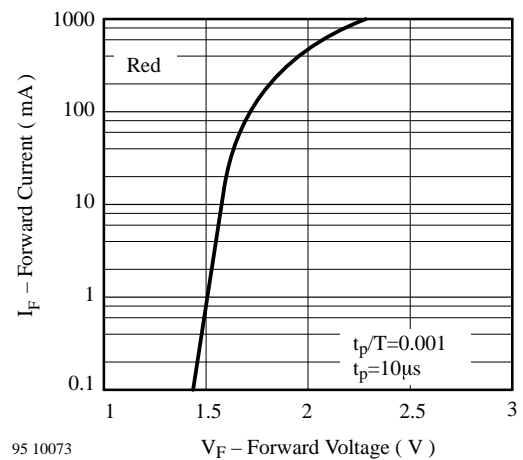
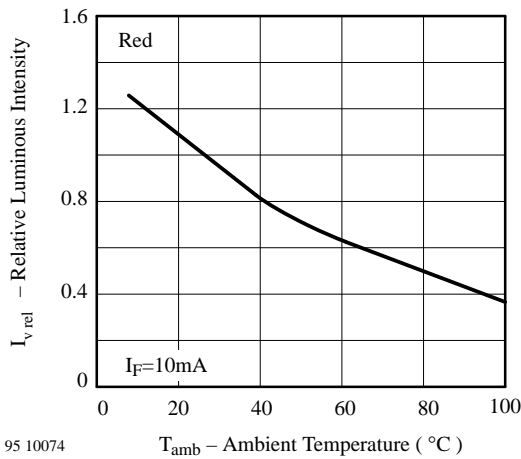
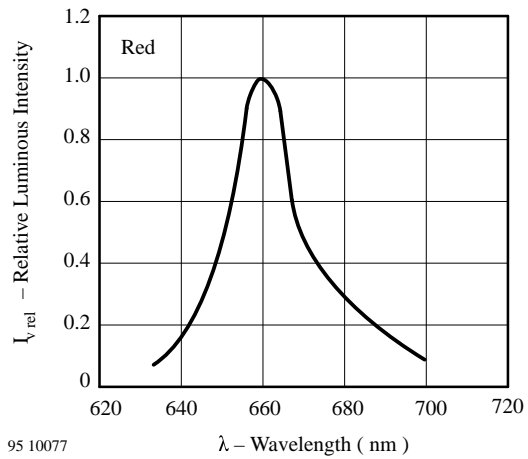

Figure 6. Forward Current vs. Forward Voltage



95 10074

Figure 7. Rel. Luminous Intensity vs. Ambient Temperature



95 10077

Figure 10. Relative Luminous Intensity vs. Wavelength

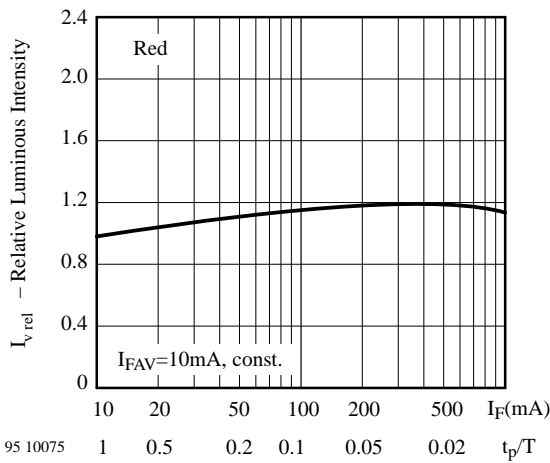

95 10075

Figure 8. Rel. Lumin. Intensity vs. Forw. Current/Duty Cycle

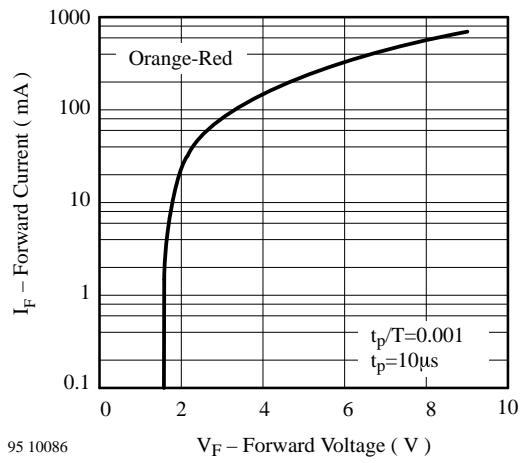

95 10086

Figure 11. Forward Current vs. Forward Voltage

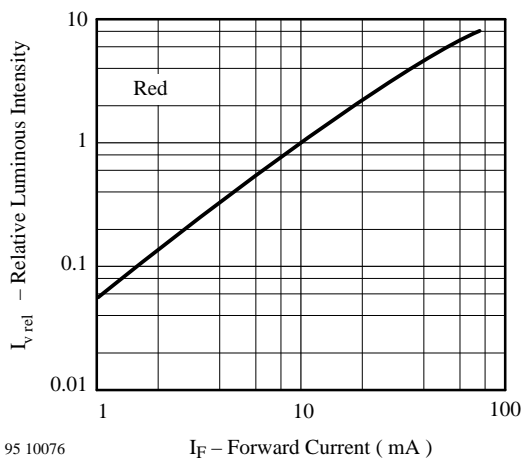

95 10076

Figure 9. Relative Luminous Intensity vs. Forward Current

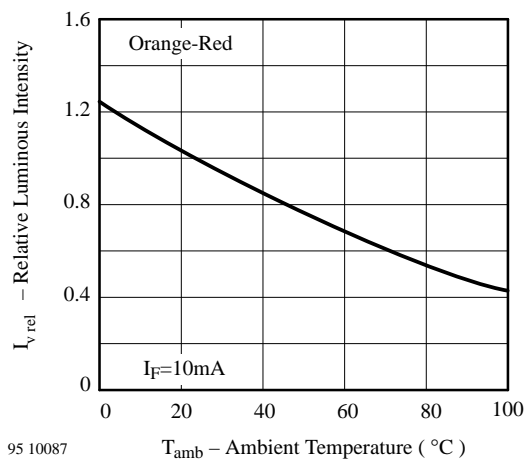

95 10087

Figure 12. Rel. Luminous Intensity vs. Ambient Temperature

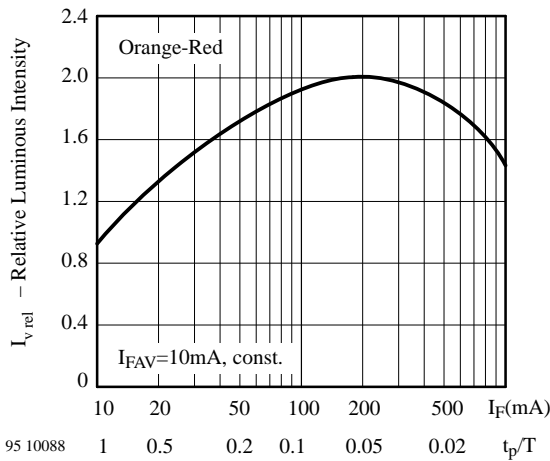

Figure 13. Rel. Lumin. Intensity vs. Forw. Current/Duty Cycle

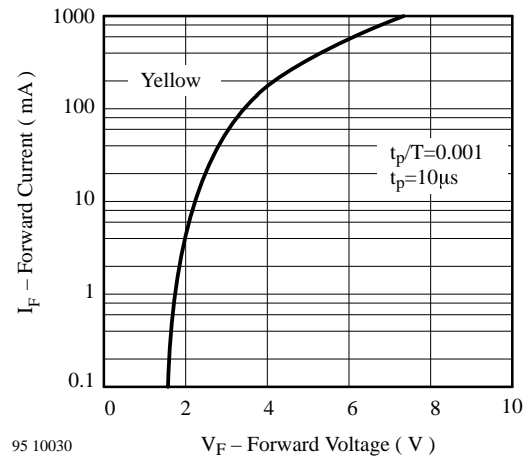

Figure 16. Forward Current vs. Forward Voltage

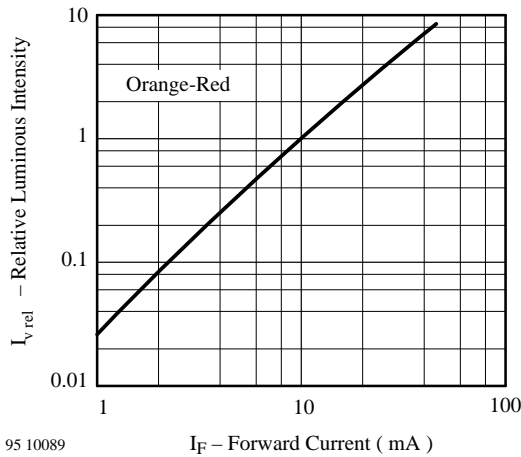

Figure 14. Relative Luminous Intensity vs. Forward Current

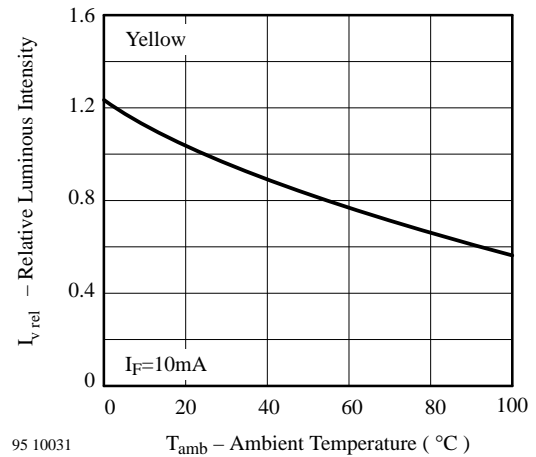

Figure 17. Rel. Luminous Intensity vs. Ambient Temperature

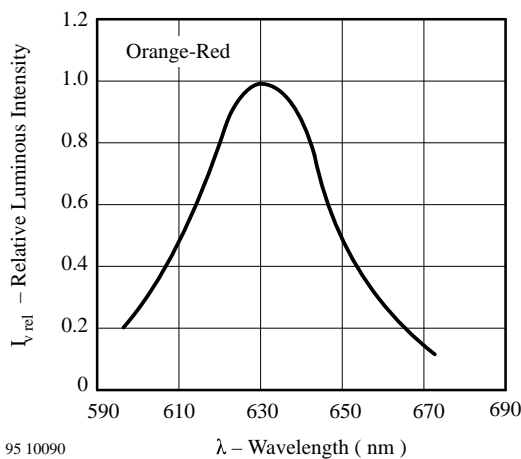

Figure 15. Relative Luminous Intensity vs. Wavelength

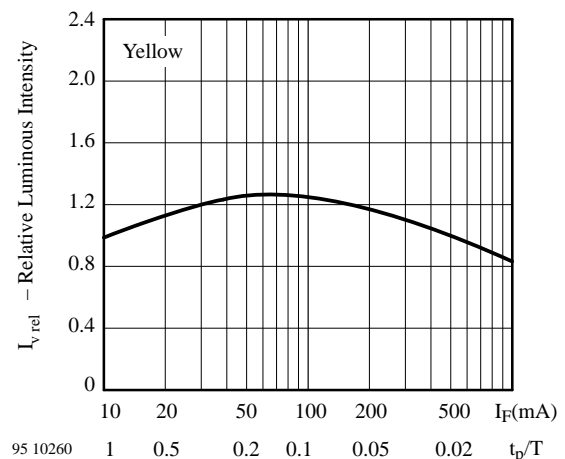
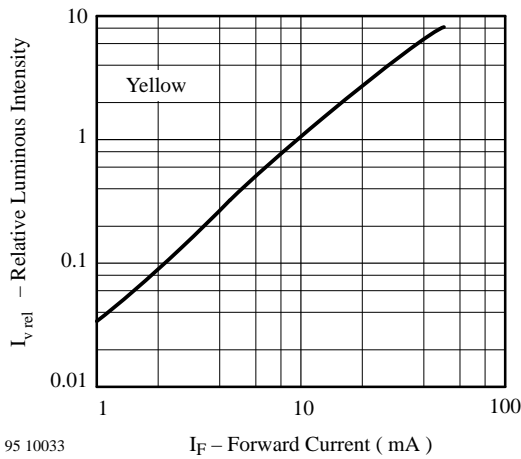

Figure 18. Rel. Lumin. Intensity vs. Forw. Current/Duty Cycle



95 10033

I_F - Forward Current (mA)

Figure 19. Relative Luminous Intensity vs. Forward Current

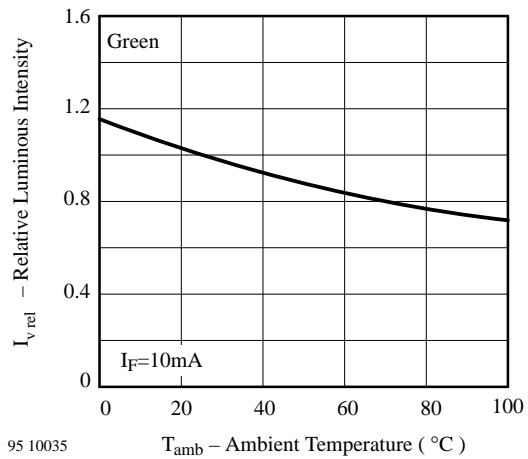

95 10035

T_{amb} - Ambient Temperature (°C)

Figure 22. Rel. Luminous Intensity vs. Ambient Temperature

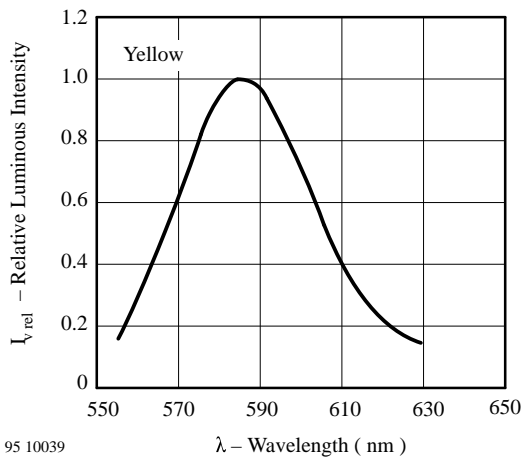

95 10039

λ - Wavelength (nm)

Figure 20. Relative Luminous Intensity vs. Wavelength

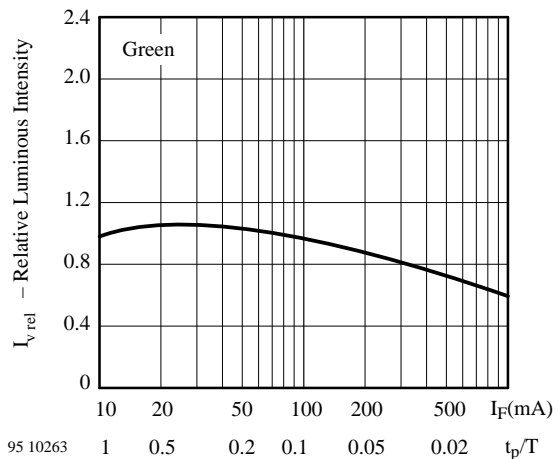

95 10263

I_F (mA)
 t_p/T

Figure 23. Rel. Lumin. Intensity vs. Forw. Current/Duty Cycle

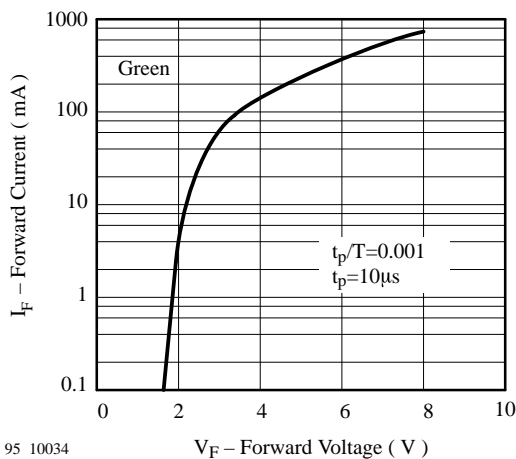

95 10034

V_F - Forward Voltage (V)

Figure 21. Forward Current vs. Forward Voltage

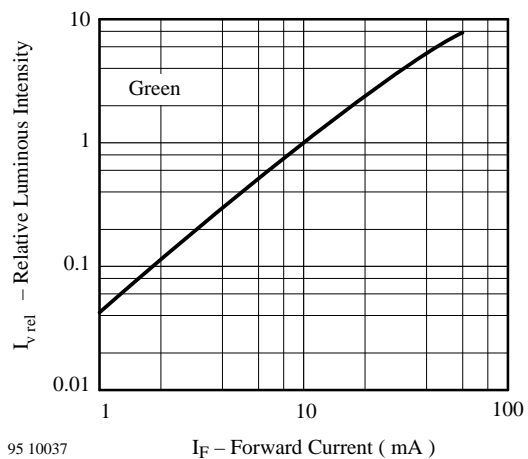

95 10037

I_F - Forward Current (mA)

Figure 24. Relative Luminous Intensity vs. Forward Current

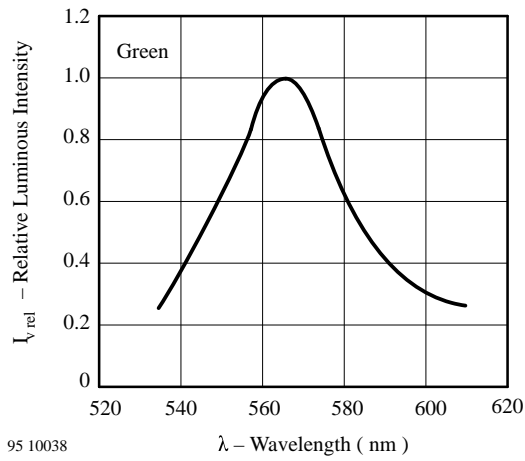
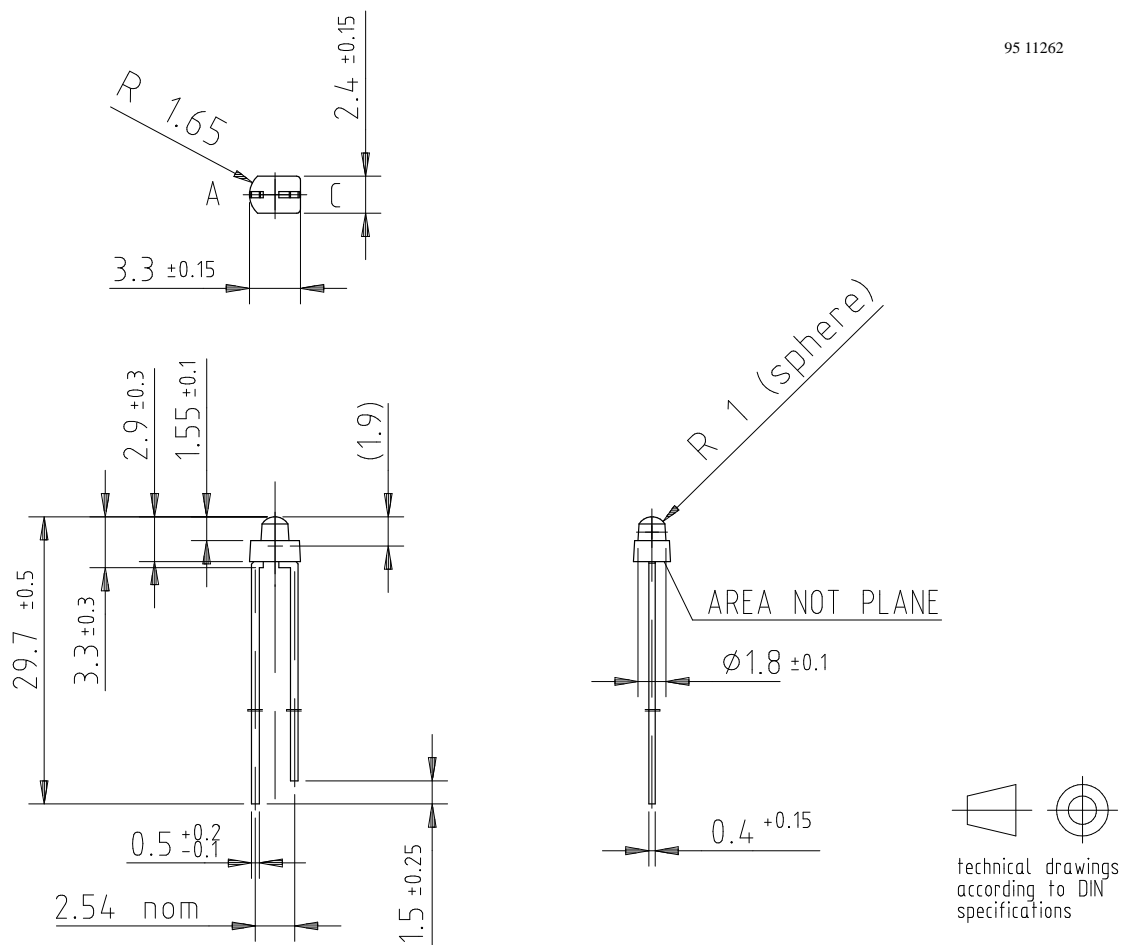

Figure 25. Relative Luminous Intensity vs. Wavelength

Dimensions in mm



Ozone Depleting Substances Policy Statement

It is the policy of **TEMIC TELEFUNKEN microelectronic GmbH** to

1. Meet all present and future national and international statutory requirements.
2. Regularly and continuously improve the performance of our products, processes, distribution and operating systems with respect to their impact on the health and safety of our employees and the public, as well as their impact on the environment.

It is particular concern to control or eliminate releases of those substances into the atmosphere which are known as ozone depleting substances (ODSs).

The Montreal Protocol (1987) and its London Amendments (1990) intend to severely restrict the use of ODSs and forbid their use within the next ten years. Various national and international initiatives are pressing for an earlier ban on these substances.

TEMIC TELEFUNKEN microelectronic GmbH semiconductor division has been able to use its policy of continuous improvements to eliminate the use of ODSs listed in the following documents.

1. Annex A, B and list of transitional substances of the Montreal Protocol and the London Amendments respectively
2. Class I and II ozone depleting substances in the Clean Air Act Amendments of 1990 by the Environmental Protection Agency (EPA) in the USA
3. Council Decision 88/540/EEC and 91/690/EEC Annex A, B and C (transitional substances) respectively.

TEMIC can certify that our semiconductors are not manufactured with ozone depleting substances and do not contain such substances.

We reserve the right to make changes to improve technical design and may do so without further notice.

Parameters can vary in different applications. All operating parameters must be validated for each customer application by the customer. Should the buyer use TEMIC products for any unintended or unauthorized application, the buyer shall indemnify TEMIC against all claims, costs, damages, and expenses, arising out of, directly or indirectly, any claim of personal damage, injury or death associated with such unintended or unauthorized use.

TEMIC TELEFUNKEN microelectronic GmbH, P.O.B. 3535, D-74025 Heilbronn, Germany
Telephone: 49 (0)7131 67 2831, Fax number: 49 (0)7131 67 2423