

## Resistor LED for 12 V Supply Voltage

Color	Type	Technology	Angle of Half Intensity $\pm\varphi$
High efficiency red	TLRH5420	GaAsP on GaP	30°
Yellow	TLRY5420	GaAsP on GaP	
Green	TLRG5420	GaP on GaP	

### Description

These devices are developed for the automotive industry with special requirements as for EMC (electro magnetic compatibility) in motor vehicles with 12 V supply voltage.

They are resistant against transient conduction (high voltage spikes) and interferences by conduction and coupling.

The TLR.542. series contains an integrated resistor for current limiting in series with the LED chip. This allows the lamp to be driven from a 12 V source without an external current limiter.

Available colors are red, yellow and green. These tinted diffused lamps provide a wide off-axis viewing angle.

These LEDs are intended for space critical applications such as automobile instrument panels, switches and others which are driven from a 12 V source.

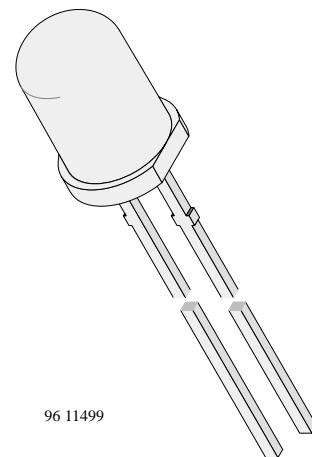

### Features

- With current limiting resistor for 12 V
- EMC specified (DIN 40 839)
- Resistant against transient high voltage spikes
- Cost effective: save space and resistor cost
- Standard  $\varnothing$  5 mm (T-1 $\frac{3}{4}$ ) package
- Wide viewing angle
- Luminous intensity categorized
- Yellow and green color categorized

### Applications

Status light in cars

OFF / ON indicator in cars

Background illumination for switches

Off/On indicator in switches

## TLR.542.

### Absolute Maximum Ratings

$T_{amb} = 25^{\circ}\text{C}$ , unless otherwise specified

**TLRH5420 , TLR5420 , TLRG5420**

Parameter	Test Conditions	Symbol	Value	Unit
Reverse voltage		$V_R$	6	V
Forward voltage	$T_{amb} \leq 65^{\circ}\text{C}$	$V_F$	16	V
Power dissipation	$T_{amb} \leq 65^{\circ}\text{C}$	$P_V$	240	mW
Junction temperature		$T_j$	100	$^{\circ}\text{C}$
Storage temperature range		$T_{stg}$	-55 to +100	$^{\circ}\text{C}$
Soldering temperature	$t \leq 5$ s, 2 mm from body	$T_{sd}$	260	$^{\circ}\text{C}$
Thermal resistance junction/ambient		$R_{thJA}$	150	K/W

### EMC Characteristics (DIN 40 839)

**TLRH5420 , TLR5420 , TLRG5420**

These LEDs are specially tested for EMC. Tests, testconditions, measurement equipment and limit values are specified in DIN 40 839 (part 1). The results for this resistor LED referring to DIN 40 839 are:

Test Impulse	Grade of Sharpness	Function Condition
1	IV	C
2	IV	C
3a	IV	A
3b	IV	A
4	IV	C
5	III	C

### Optical and Electrical Characteristics

$T_{amb} = 25^{\circ}\text{C}$ , unless otherwise specified

**High efficiency red (TLRH5420)**

Parameter	Test Conditions	Type	Symbol	Min	Typ	Max	Unit
Luminous intensity	$V_F = 12$ V		$I_V$	1.6	4		mcd
Dominant wavelength	$V_F = 12$ V		$\lambda_d$	612		625	nm
Peak wavelength	$V_F = 12$ V		$\lambda_p$		635		nm
Angle of half intensity	$V_F = 12$ V		$\phi$		$\pm 30$		deg
Forward current	$V_S = 12$ V		$I_F$		10	12	mA
Breakdown voltage	$I_R = 10$ $\mu\text{A}$		$V_{BR}$	6	70		V
Junction capacitance	$V_R = 0$ , $f = 1$ MHz		$C_j$		50		pF

**Yellow (TLRY5420)**

Parameter	Test Conditions	Type	Symbol	Min	Typ	Max	Unit
Luminous intensity	$V_F = 12\text{ V}$		$I_V$	1.6	4		mcd
Dominant wavelength	$V_F = 12\text{ V}$		$\lambda_d$	581		594	nm
Peak wavelength	$V_F = 12\text{ V}$		$\lambda_p$		585		nm
Angle of half intensity	$V_F = 12\text{ V}$		$\phi$		$\pm 30$		deg
Forward current	$V_S = 12\text{ V}$		$I_F$		10	12	mA
Breakdown voltage	$I_R = 10\text{ }\mu\text{A}$		$V_{BR}$	6	70		V
Junction capacitance	$V_R = 0, f = 1\text{ MHz}$		$C_j$		50		pF

**Green (TLRG5420)**

Parameter	Test Conditions	Type	Symbol	Min	Typ	Max	Unit
Luminous intensity	$V_F = 12\text{ V}$		$I_V$	1.6	4		mcd
Dominant wavelength	$V_F = 12\text{ V}$		$\lambda_d$	562		575	nm
Peak wavelength	$V_F = 12\text{ V}$		$\lambda_p$		565		nm
Angle of half intensity	$V_F = 12\text{ V}$		$\phi$		$\pm 30$		deg
Forward current	$V_S = 12\text{ V}$		$I_F$		10	12	mA
Breakdown voltage	$I_R = 10\text{ }\mu\text{A}$		$V_{BR}$	6	70		V
Junction capacitance	$V_R = 0, f = 1\text{ MHz}$		$C_j$		50		pF

## Typical Characteristics ( $T_{amb} = 25^{\circ}C$ , unless otherwise specified)

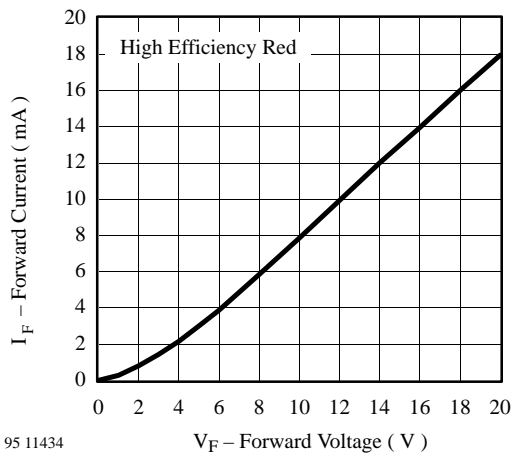

Figure 1. Forward Current vs. Forward Voltage

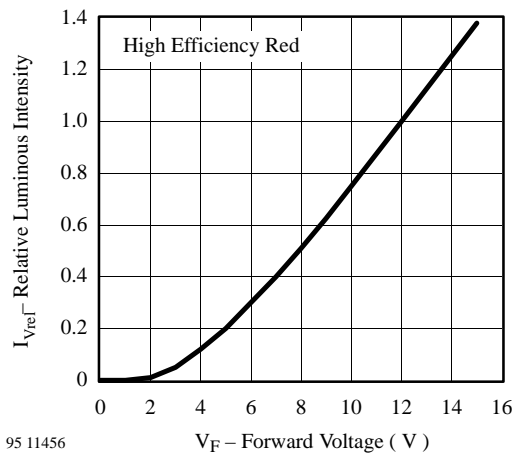

Figure 4. Relative Luminous Intensity vs. Forward Voltage

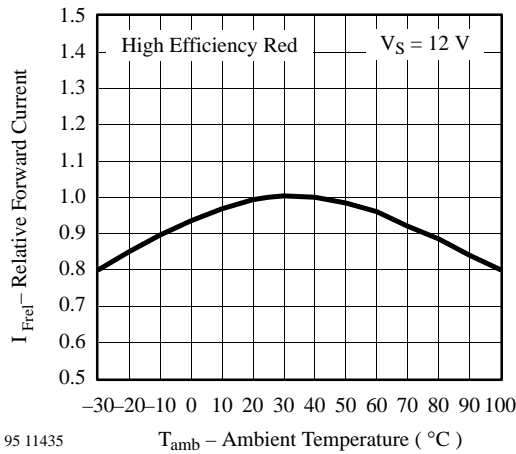

Figure 2. Relative Forward Current vs. Ambient Temperature

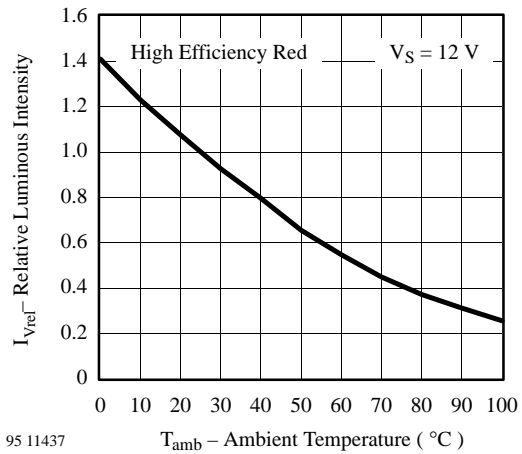

Figure 5. Rel. Luminous Intensity vs. Ambient Temperature

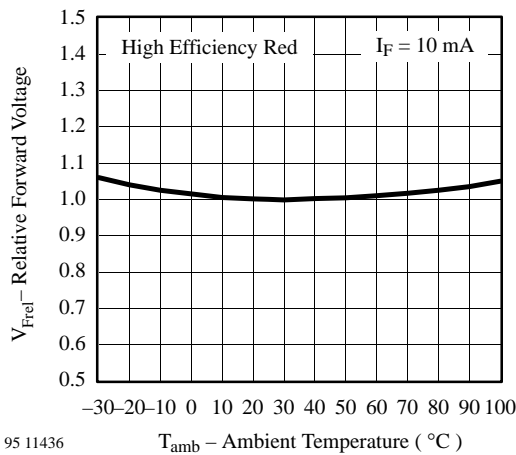

Figure 3. Relative Forward Voltage vs. Ambient Temperature

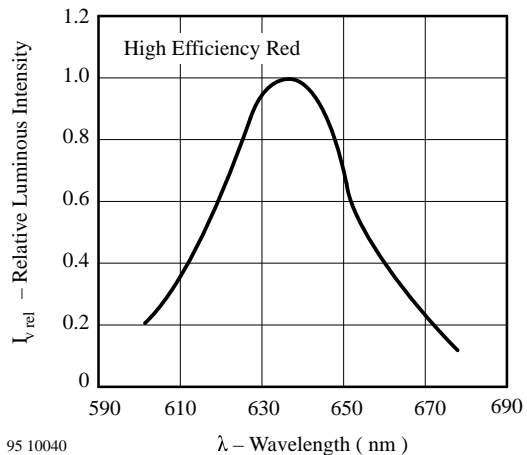

Figure 6. Relative Luminous Intensity vs. Wavelength

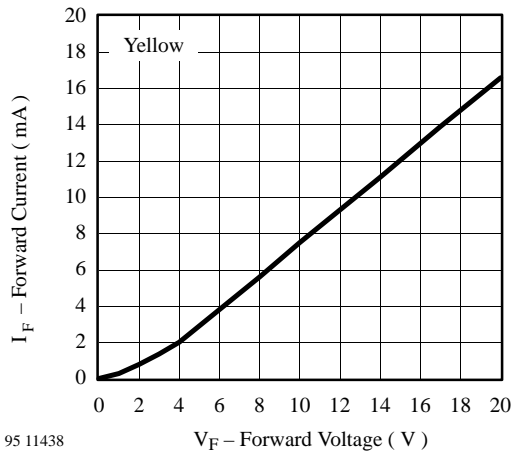

Figure 7. Forward Current vs. Forward Voltage

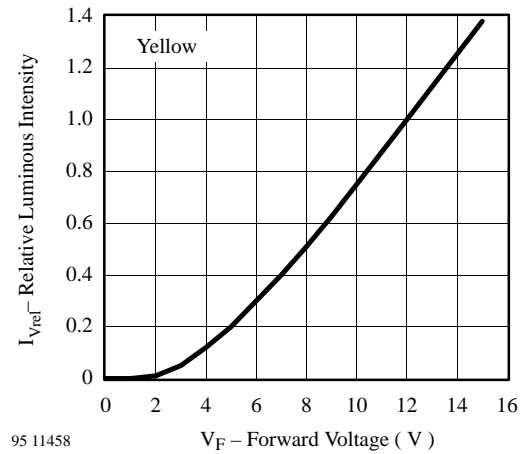

Figure 10. Relative Luminous Intensity vs. Forward Voltage

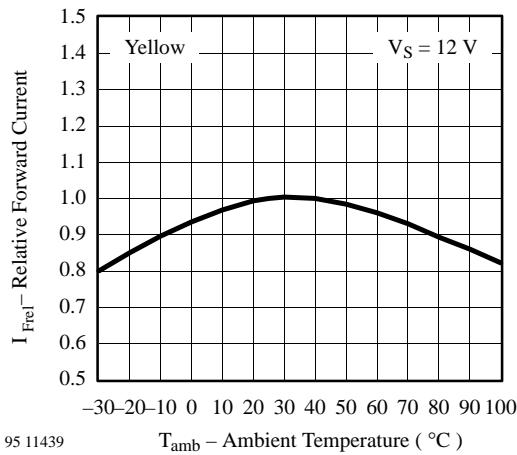

Figure 8. Relative Forward Current vs. Ambient Temperature

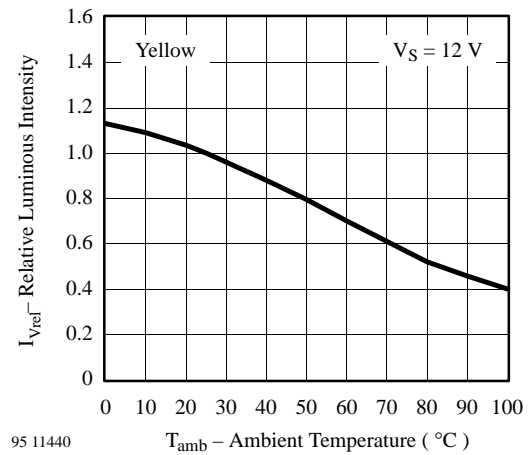

Figure 11. Rel. Luminous Intensity vs. Ambient Temperature

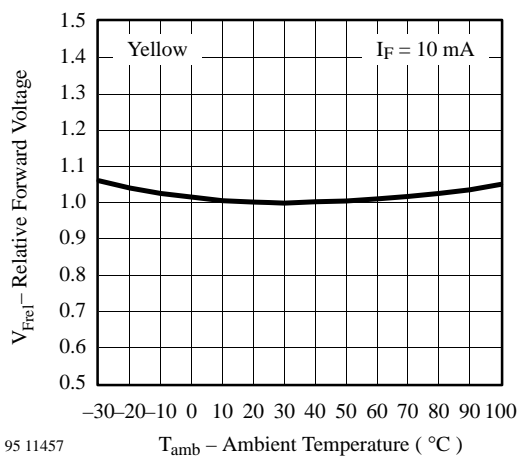

Figure 9. Relative Forward Voltage vs. Ambient Temperature

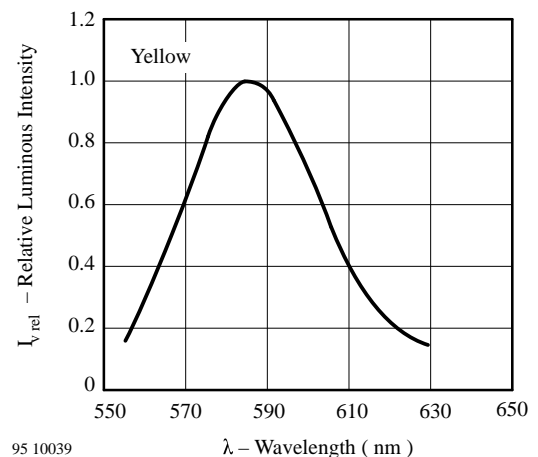
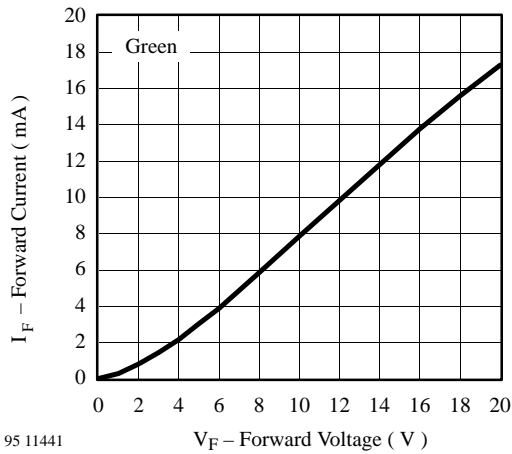
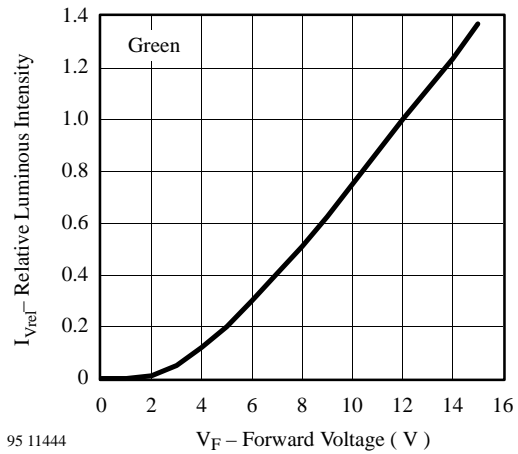

Figure 12. Relative Luminous Intensity vs. Wavelength



95 11441

Figure 13. Forward Current vs. Forward Voltage



95 11444

Figure 16. Relative Luminous Intensity vs. Forward Voltage

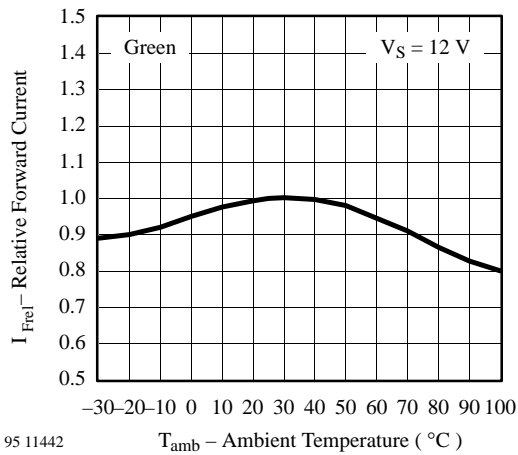

95 11442

Figure 14. Relative Forward Current vs. Ambient Temperature

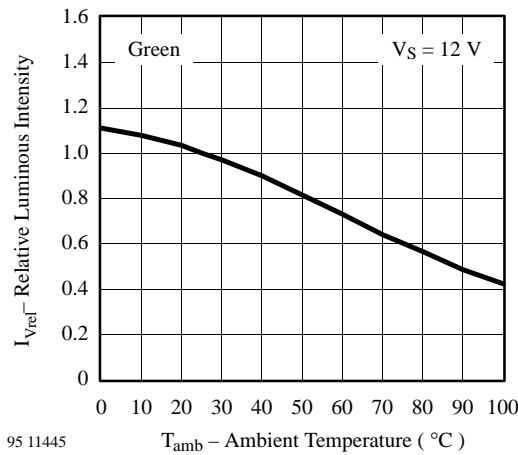

95 11445

Figure 17. Rel. Luminous Intensity vs. Ambient Temperature

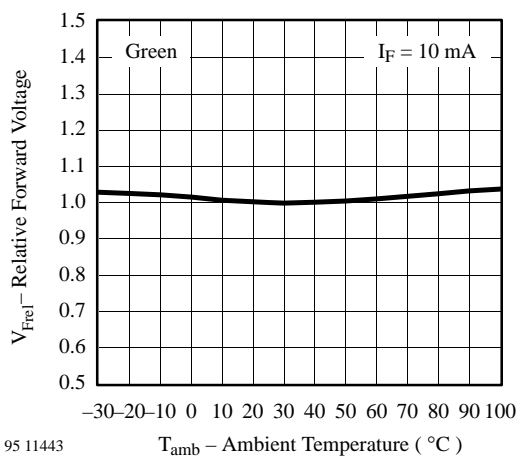

95 11443

Figure 15. Relative Forward Voltage vs. Ambient Temperature

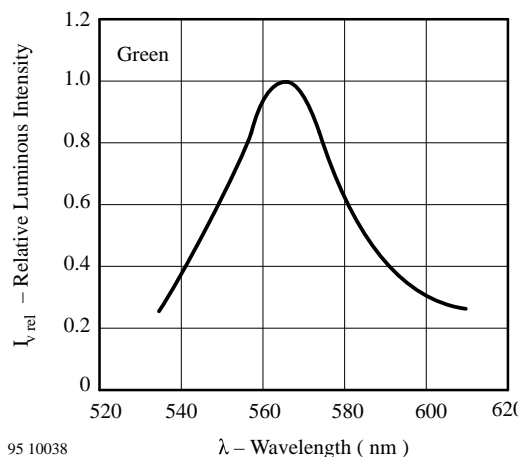

95 10038

Figure 18. Relative Luminous Intensity vs. Wavelength

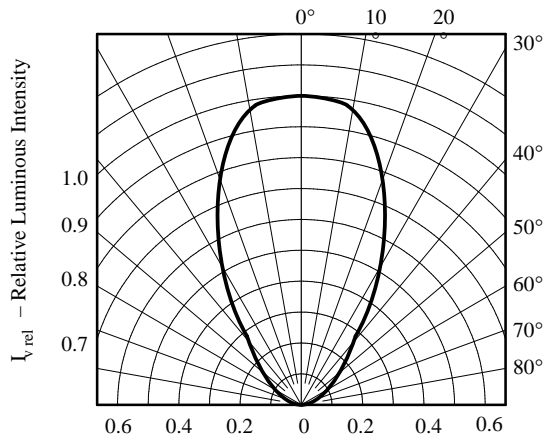

95 10042

Figure 19. Rel. Luminous Intensity vs. Angular Displacement

## Dimensions in mm

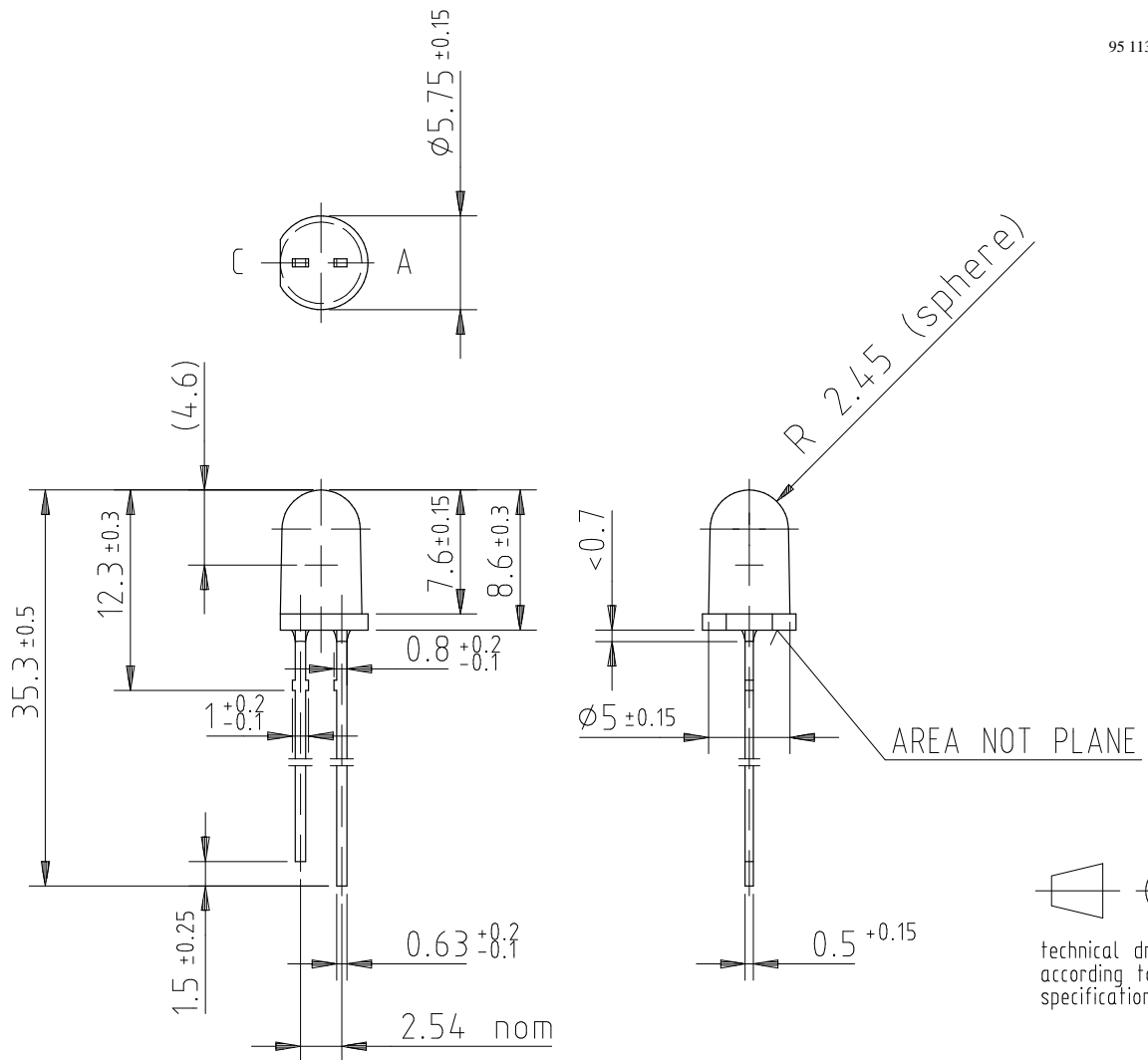

95 11328

## Ozone Depleting Substances Policy Statement

It is the policy of **TEMIC TELEFUNKEN microelectronic GmbH** to

1. Meet all present and future national and international statutory requirements.
2. Regularly and continuously improve the performance of our products, processes, distribution and operating systems with respect to their impact on the health and safety of our employees and the public, as well as their impact on the environment.

It is particular concern to control or eliminate releases of those substances into the atmosphere which are known as ozone depleting substances (ODSs).

The Montreal Protocol (1987) and its London Amendments (1990) intend to severely restrict the use of ODSs and forbid their use within the next ten years. Various national and international initiatives are pressing for an earlier ban on these substances.

**TEMIC TELEFUNKEN microelectronic GmbH** semiconductor division has been able to use its policy of continuous improvements to eliminate the use of ODSs listed in the following documents.

1. Annex A, B and list of transitional substances of the Montreal Protocol and the London Amendments respectively
2. Class I and II ozone depleting substances in the Clean Air Act Amendments of 1990 by the Environmental Protection Agency (EPA) in the USA
3. Council Decision 88/540/EEC and 91/690/EEC Annex A, B and C (transitional substances) respectively.

**TEMIC** can certify that our semiconductors are not manufactured with ozone depleting substances and do not contain such substances.

**We reserve the right to make changes to improve technical design and may do so without further notice.**

Parameters can vary in different applications. All operating parameters must be validated for each customer application by the customer. Should the buyer use TEMIC products for any unintended or unauthorized application, the buyer shall indemnify TEMIC against all claims, costs, damages, and expenses, arising out of, directly or indirectly, any claim of personal damage, injury or death associated with such unintended or unauthorized use.

TEMIC TELEFUNKEN microelectronic GmbH, P.O.B. 3535, D-74025 Heilbronn, Germany  
Telephone: 49 (0)7131 67 2831, Fax number: 49 (0)7131 67 2423