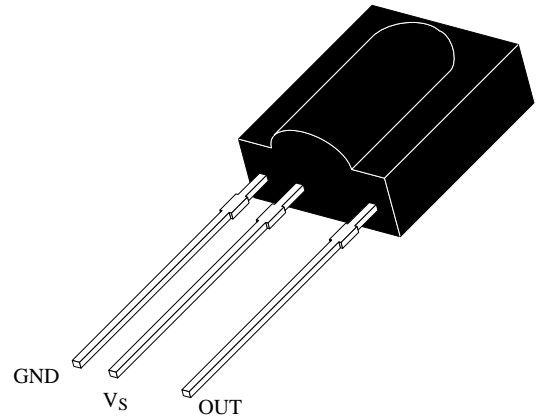

**Photo Module for PCM Remote Control Systems**

**Available types for different carrier frequencies**

Type	f <sub>0</sub>	Type	f <sub>0</sub>
TFMS2300	30 kHz	TFMS2330	33 kHz
TFMS2360	36 kHz	TFMS2370	36.7 kHz
TFMS2380	38 kHz	TFMS2400	40 kHz
TFMS2560	56 kHz		



94 8691

**Description**

The TFMS2..0 is a miniaturized receiver for infrared remote control systems. PIN diode and preamplifier are assembled on lead frame, the epoxy package is designed as IR filter.

The demodulated output signal can directly be decoded by a microprocessor. The main benefit is the reliable function even in disturbed ambient and the protection against uncontrolled output pulses.

**Features**

- Photo detector and preamplifier in one package
- Receiver module for transmission codes with long bursts ( $N \geq 20$  pulses per bit)
- Enhanced integration time against neon light disturbances
- Output active low
- Internal filter for PCM frequency
- Reduced duty cycle for improved immunity against switchmode fluorescent lamps
- Improved shielding against electric field disturbance
- 5 Volt supply voltage
- TTL and CMOS compatibility
- Low power consumption (typical 2.5 mW)

**Block Diagram**

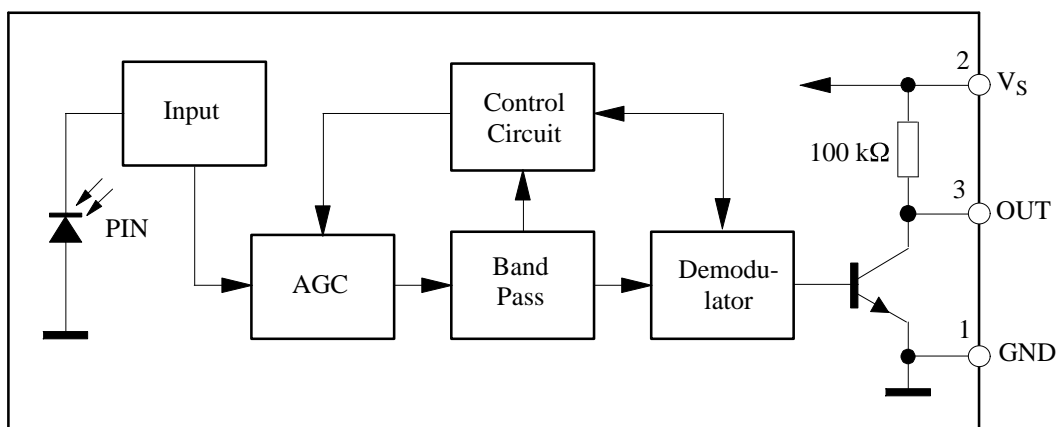

94 9148

## Absolute Maximum Ratings

$T_{amb} = 25^{\circ}\text{C}$

Parameter	Test Conditions	Symbol	Value	Unit
Supply Voltage	(Pin 2)	$V_S$	-0.3...6.0	V
Supply Current	(Pin 2)	$I_S$	5	mA
Output Voltage	(Pin 3)	$V_O$	-0.3...6.0	V
Output Current	(Pin 3)	$I_O$	5	mA
Junction Temperature		$T_j$	100	$^{\circ}\text{C}$
Storage Temperature Range		$T_{stg}$	-25...+85	$^{\circ}\text{C}$
Operating Temperature Range		$T_{amb}$	-25...+85	$^{\circ}\text{C}$
Power Consumption	( $T_{amb} \leq 85^{\circ}\text{C}$ )	$P_{tot}$	50	mW
Soldering Temperature	$t \leq 10\text{ s}$	$T_{sd}$	260	$^{\circ}\text{C}$

## Basic Characteristics

$T_{amb} = 25^{\circ}\text{C}$

Parameter	Test Conditions	Symbol	Min	Typ	Max	Unit
Supply Current (Pin 2)	$V_S = 5\text{ V}, E_v = 0$	$I_{SD}$	0.4	0.5	0.8	mA
	$V_S = 5\text{ V}, E_v = 40\text{ klx}$ , sunlight	$I_{SH}$		1.0		mA
Transmission Distance	$E_v = 0$ , test signal see fig.7, IR diode TSIP5201, $I_F = 0.4\text{ A}$	$d$		35		m
Output Voltage Low (Pin 3)	$I_{OSL} = 0.5\text{ mA}, E_e = 0.7\text{ mW/m}^2$ , $f = f_{0.7}$ , test signal see fig.7	$V_{OSL}$			250	mV
Irradiance	Test signal see fig.7	$E_{e\ min}$		0.35	0.5	$\text{mW/m}^2$
Irradiance	Test signal see fig.7	$E_{e\ max}$	20			$\text{W/m}^2$
Directivity	Angle of half transmission distance	$\phi_{1/2}$		$\pm 55$		deg

## Application Circuit

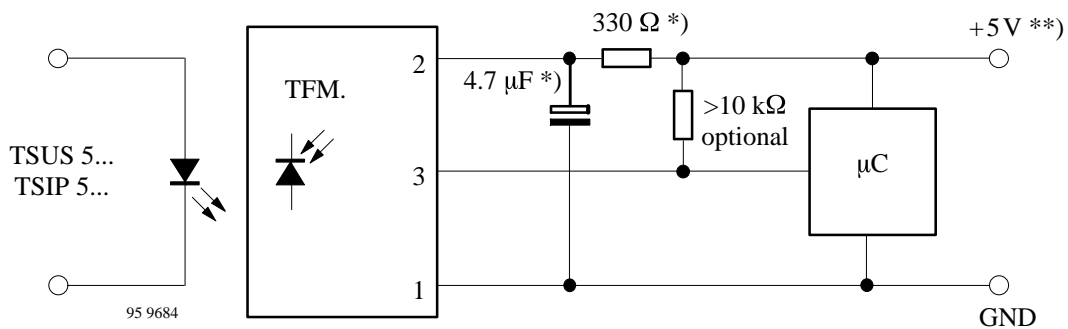

\*) only necessary to suppress power supply disturbances

\*\*\*) tolerated supply voltage range :  $4.5\text{ V} < V_S < 5.5\text{ V}$

**Typical Characteristics** ( $T_{amb} = 25^{\circ}C$  unless otherwise specified)

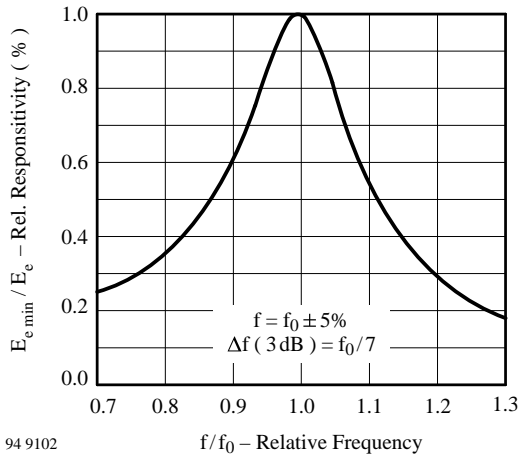

Figure 1. Frequency Dependence of Responsivity

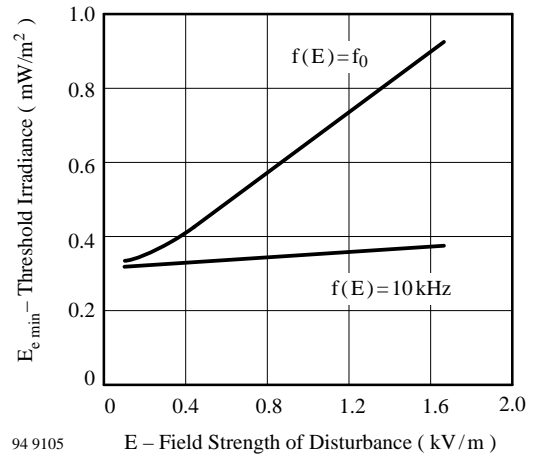

Figure 4. Sensitivity vs. Electric Field Disturbances

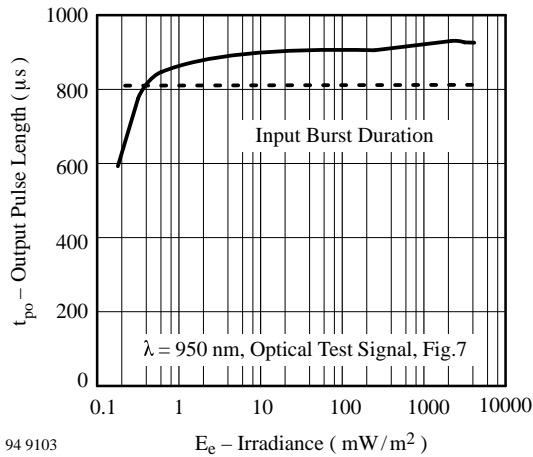

Figure 2. Sensitivity in Dark Ambient

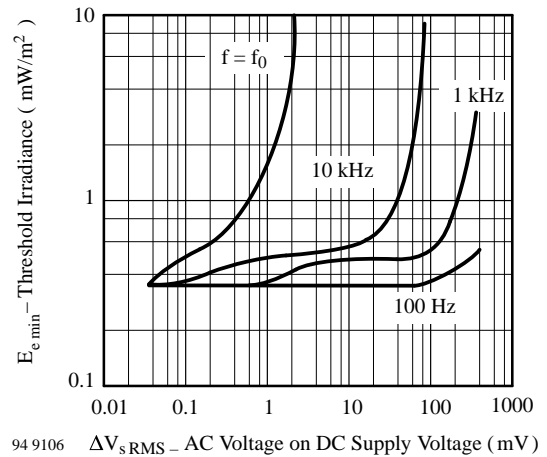

Figure 5. Sensitivity vs. Supply Voltage Disturbances

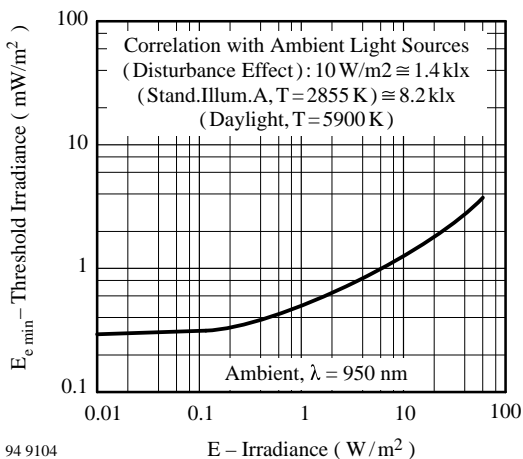

Figure 3. Sensitivity in Bright Ambient

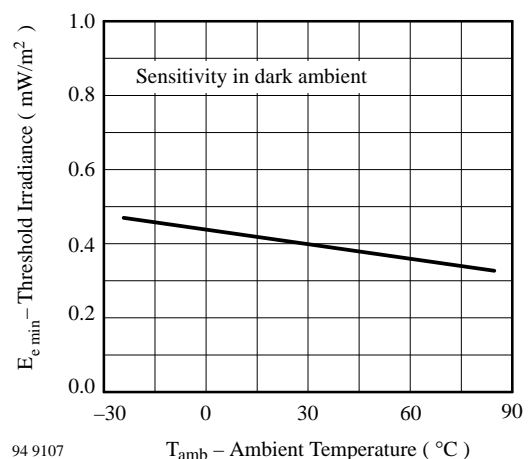

Figure 6. Sensitivity vs. Ambient Temperature

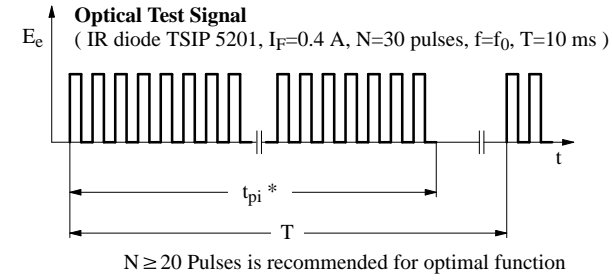

Figure 7. Output Function

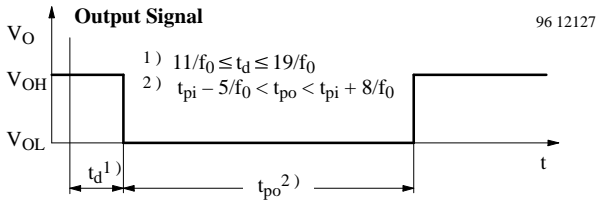

Figure 8. Output Function

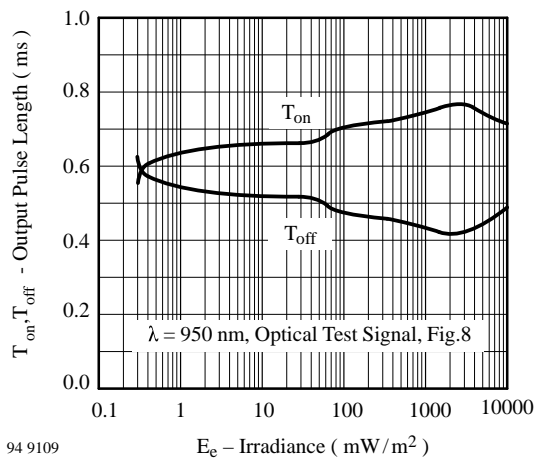

Figure 9. Output Pulse Diagram

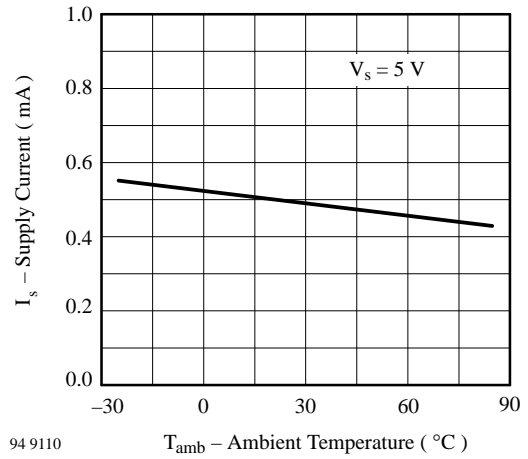

Figure 10. Supply Current vs. Ambient Temperature

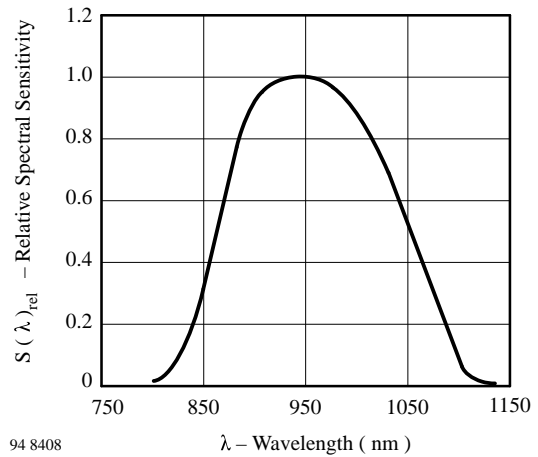

Figure 11. Spectral Response

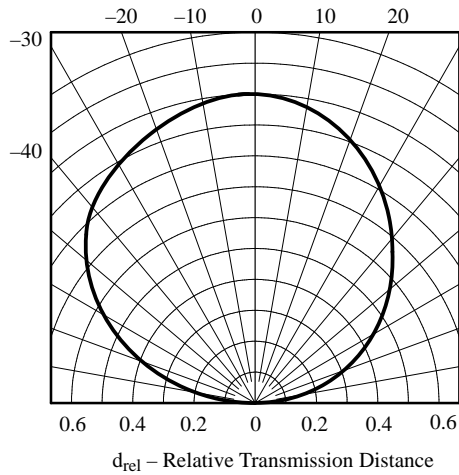

Figure 12. Vertical Directivity  $\phi_y$

94 8152

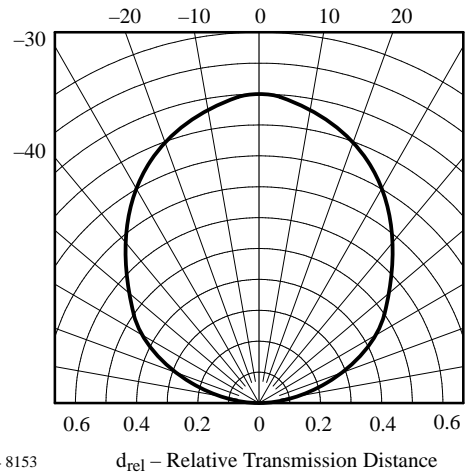
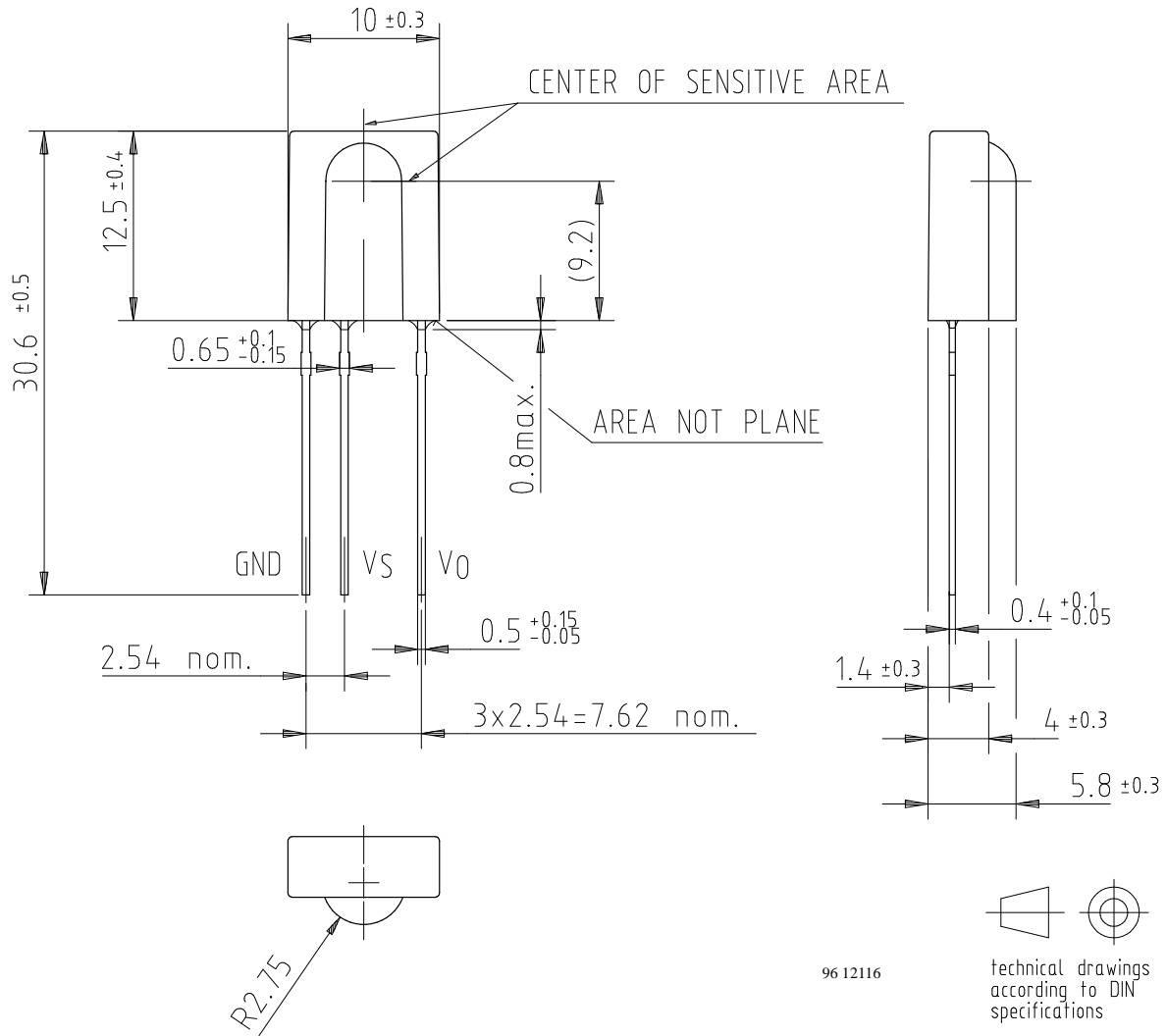

Figure 13. Horizontal Directivity  $\phi_x$

94 8153

**Dimensions in mm**



## Ozone Depleting Substances Policy Statement

It is the policy of **TEMIC TELEFUNKEN microelectronic GmbH** to

1. Meet all present and future national and international statutory requirements.
2. Regularly and continuously improve the performance of our products, processes, distribution and operating systems with respect to their impact on the health and safety of our employees and the public, as well as their impact on the environment.

It is particular concern to control or eliminate releases of those substances into the atmosphere which are known as ozone depleting substances (ODSs).

The Montreal Protocol (1987) and its London Amendments (1990) intend to severely restrict the use of ODSs and forbid their use within the next ten years. Various national and international initiatives are pressing for an earlier ban on these substances.

**TEMIC TELEFUNKEN microelectronic GmbH** semiconductor division has been able to use its policy of continuous improvements to eliminate the use of ODSs listed in the following documents.

1. Annex A, B and list of transitional substances of the Montreal Protocol and the London Amendments respectively
2. Class I and II ozone depleting substances in the Clean Air Act Amendments of 1990 by the Environmental Protection Agency (EPA) in the USA
3. Council Decision 88/540/EEC and 91/690/EEC Annex A, B and C (transitional substances) respectively.

**TEMIC** can certify that our semiconductors are not manufactured with ozone depleting substances and do not contain such substances.

**We reserve the right to make changes to improve technical design and may do so without further notice.**

Parameters can vary in different applications. All operating parameters must be validated for each customer application by the customer. Should the buyer use TEMIC products for any unintended or unauthorized application, the buyer shall indemnify TEMIC against all claims, costs, damages, and expenses, arising out of, directly or indirectly, any claim of personal damage, injury or death associated with such unintended or unauthorized use.

TEMIC TELEFUNKEN microelectronic GmbH, P.O.B. 3535, D-74025 Heilbronn, Germany  
Telephone: 49 (0)7131 67 2831, Fax number: 49 (0)7131 67 2423