

**STEREO CASSETTE PLAYER AND
MOTOR SPEED CONTROLLER**

- WIDE OPERATING SUPPLY VOLTAGE (1.8V to 6V)
- HIGH OUTPUT POWER (30mW/32Ω/3V)
- LOW DISTORTION DC VOLUME CONTROL
- NO BOUCHEROT CELL
- LOW QUIESCENT CURRENT (15mA)
- NO INPUT CAPACITORS FOR PREAMPLIFIERS
- LOW MOTOR REFERENCE VOLTAGE (200mV)

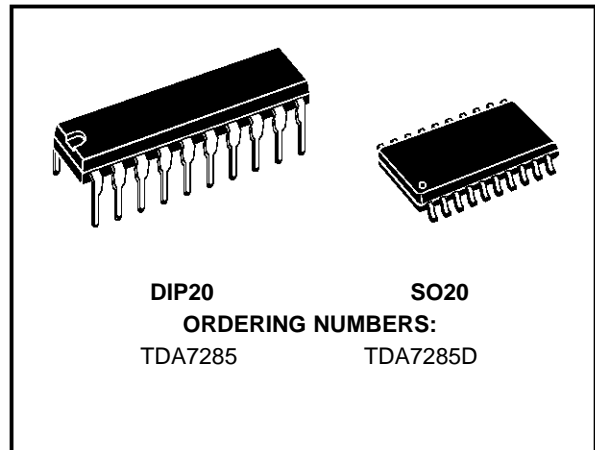

DESCRIPTION

The TDA7285 is a monolithic integrated circuit designed for the portable players market and assembled in a plastic DIP20 and SO20. The internal functions are: preamplifier, DC volume control, headphone driver and motor speed controller.

control, headphone driver and motor speed controller.

BLOCK DIAGRAM

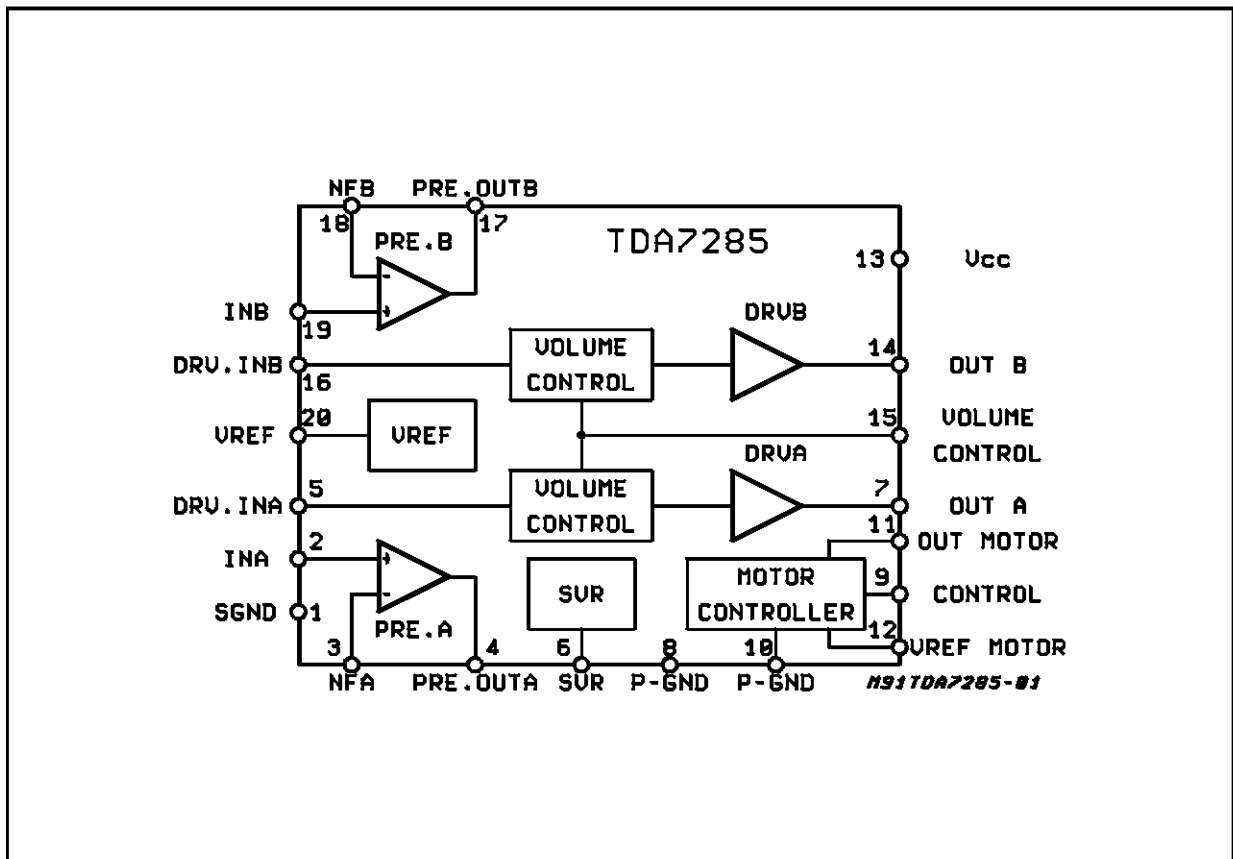

PIN CONNECTION (Top view)

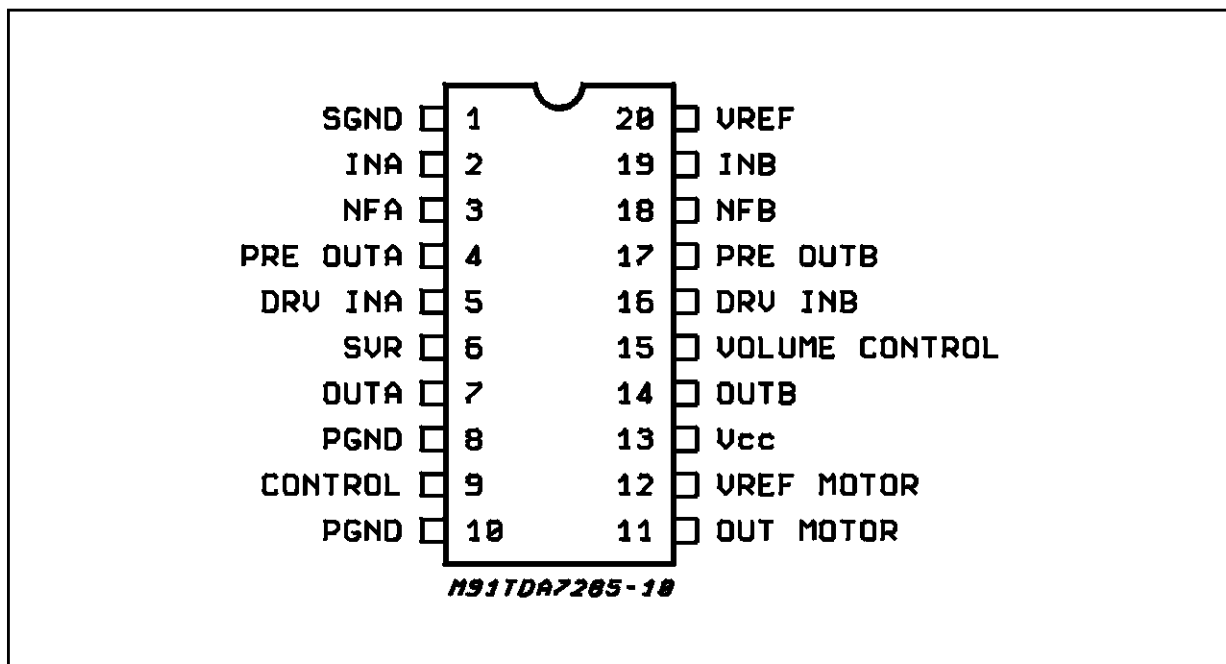

ABSOLUTE MAXIMUM RATINGS

Symbol	Parameter	Value	Unit
V_S	Supply Voltage	8	V
I_{Omax}	Maximum Output Current	70	mA
$I_{m\ max}$	Maximum Motor Current	700	mA
P_{tot}	Total Power Dissipation $T_{amb} = 90^\circ\text{C}$	0.9	W
T_{op}	Operating Temperature	-20 to +70	$^\circ\text{C}$
T_{stg}, T_j	Storage and Junction Temperature	-40 to 150	$^\circ\text{C}$

THERMAL DATA

Symbol	Description	SO20	DIP20	Unit
$R_{th\ j-amb}$	Thermal Resistance Junction-ambient	150	100	$^\circ\text{C}/\text{W}$

DC CHARACTERISTICS ($T_{amb} = 25^\circ\text{C}$; $V_S = 3\text{V}$; $R_L = 32\Omega$ (Headphone) and $R_L = 10\text{K}\Omega$ (Preamplifier); $V_i = 0$; VOL. Control = V_{ref}).

Terminal No	1	2	3	4	5	6	7	8	9	10	11	12	13	14	15	16	17	18	19	20
Term. Volt. (V)	0	1.5	1.5	1.5	1.5	2.7	1.4	0	2.8	0	1.6	3	3	1.4	1.5	1.5	1.5	1.5	1.5	1.5

ELECTRICAL CHARACTERISTICS ($V_S = 3V$; $R_L = 32\Omega$, Vol. Control = $2/3 V_{ref}$ (pin 20); $T_{amb} = 25^\circ C$; $f = 1KHz$; unless otherwise specified)

Symbol	Parameter	Test Condition	Min.	Typ.	Max.	Unit
V_S	Supply Range		1.8		6	V
I_d	Total Quiescent Drain Current			15	22	mA

PLAYBACK AMPLIFIER

G_{vo}	Open Loop Gain			70		dB
G_v	Close Loop Gain			33		dB
V_O	Output Voltage	THD = 1%	600	750		mV
THD	Total Harmonic Distortion	$V_O = 330mV_{rms}$		0.05	0.25	%
I_b	Bias Current			3		μA
C_t	Cross Talk	$R_S = 2.2K\Omega$; $V_O = 330mV_{rms}$		74		dB
e_n	Total Input Noise	$R_S = 2.2K\Omega$; $B = 22Hz$ to $22KHz$		1.2		μV
SVR1	Ripple Rejection	$R_S = 2.2K\Omega$; $V_r = 100mV_{rms}$ $f = 100Hz$; $C_{SVR} = 100\mu F$		50		dB

HEADPHONE DRIVER

V_{DC}	Output DC Voltage			1.4		V
P_O	Output Power	THD = 10%	20	30		mW
P_{O1}	Transient Output Power	THD = 10% $R_L = 16\Omega$		50		mW
G_v	Close Loop Gain	$P_O = 5mW$		31		dB
	Volume Control range		66	75		dB
THD	Total Harmonic Distortion	$P_O = 5mW$		0.3	1	%
C_t	Cross Talk	$P_O = 5mW$; $R_S = 10K\Omega$		50		dB
SVR2	Ripple Rejection	$R_S = 600\Omega$; $V_r = 100mV$ $f = 100Hz$; $C_{SVR} = 100\mu F$		47		dB

MOTOR SPEED CONTROL

V_{ref}	Motor Reference Voltage (pin 12)		0.18	0.20	0.22	V
K	Shunt Ratio	$I_m = 100mA$	45	50	55	-
V_{sat}	Residual Voltage	$I_m = 100mA$		0.13	0.30	V
$\frac{\Delta V_{ref}}{V_{ref}} / \Delta V_S$	Line Regulation	$I_m = 100mA$; $V_S = 1.8$ to $6V$		0.20	0.8	%/V
$\frac{\Delta K}{K} / \Delta V_S$	Voltage Characteristics of Shunt Ratio	$I_m = 100mA$; $V_S = 1.8$ to $6V$		0.80	3	%/V
$\frac{\Delta V_{ref}}{V_{ref}} / \Delta I_m$	Load Regulation	$I_m = 30$ to $200mA$		0.015	0.08	%/mA
$\frac{\Delta K}{K} / \Delta I_m$	Current Characteristics of Shunt Ratio	$I_m = 30$ to $200mA$		0.03	0.1	%/mA
$\frac{\Delta V_{ref}}{V_{ref}} / \Delta T_{amb}$	Temperature Characteristics of Reference Voltage	$I_m = 100mA$ $T_{amb} = -20$ to $+60^\circ C$		0.04		%/°C
$\frac{\Delta K}{K} / \Delta T_{amb}$	Temperature Characteristics of Shunt Ratio	$I_m = 100mA$ $T_{amb} = -20$ to $+60^\circ C$		0.02		%/°C

Figure 1: Test and Application Circuit

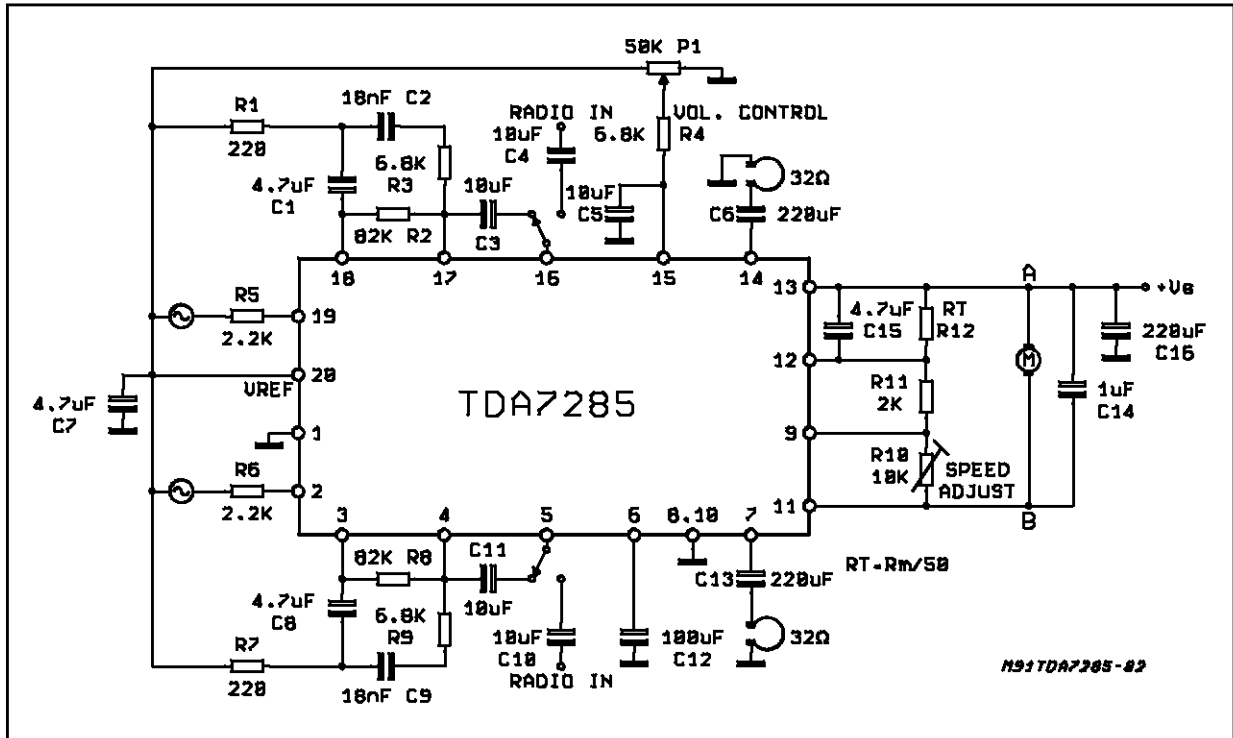

Figure 2: P.C. Board and Component Layout of the Circuit of Figure 2 (1:1 scale)

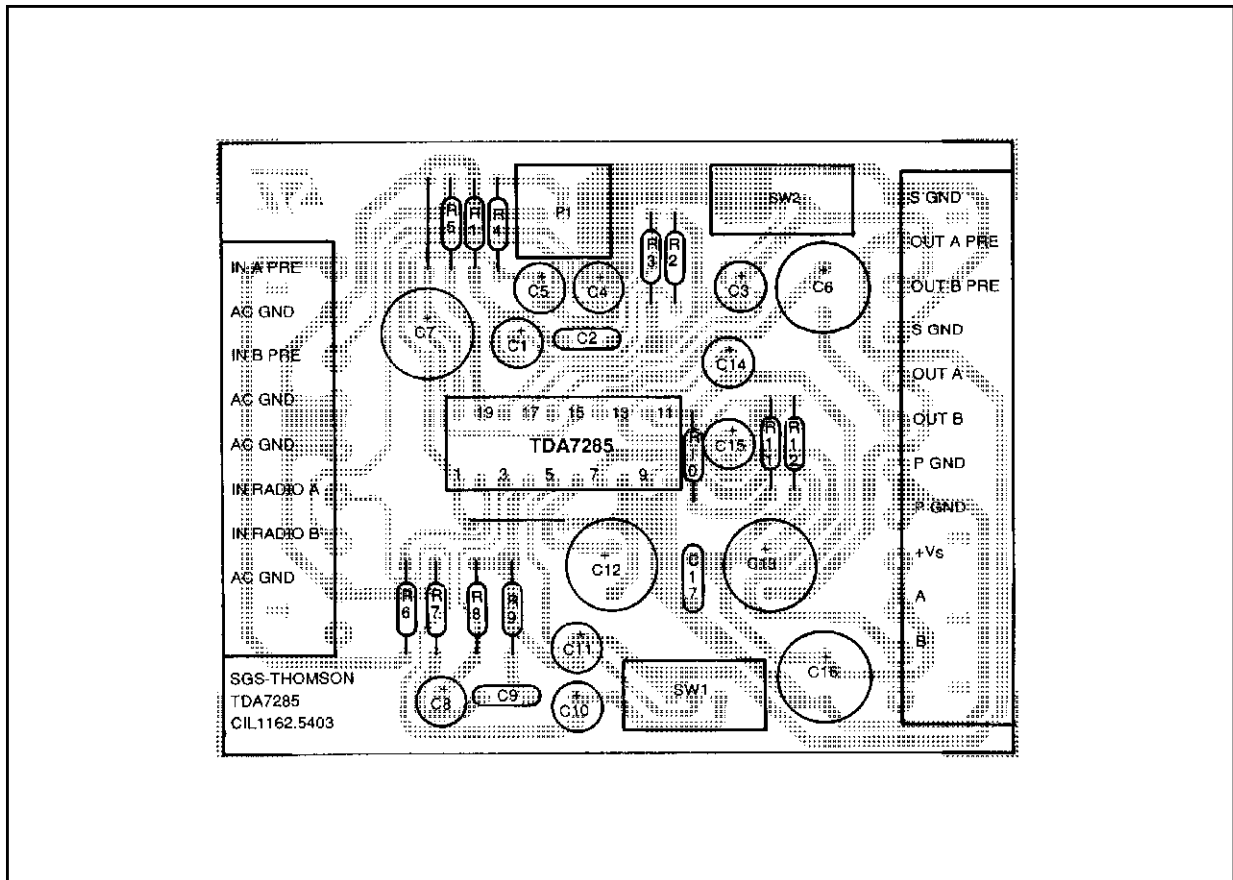

Figure 3: Quiescent Drain Current vs. Supply Voltage

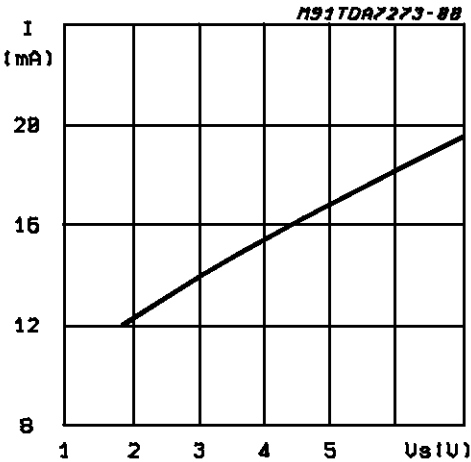

Figure 4: Reference voltage $V_{S/2}$ (pin 20) vs. Supply Voltage

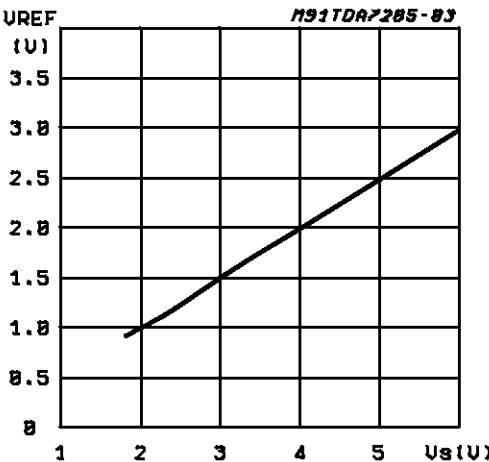

Figure 5: Closed Loop Gain vs. Frequency (PREAMPLIFIER)

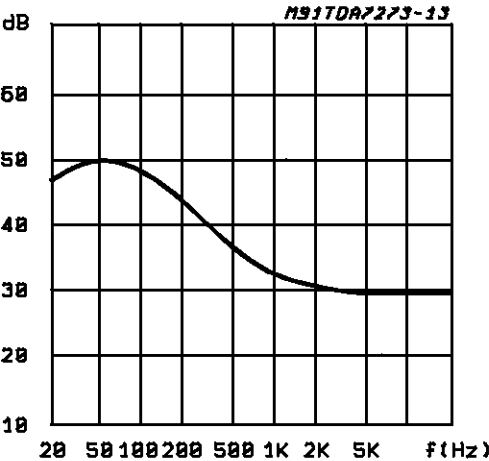

Figure 6: Distortion vs. Frequency (PREAMPLIFIER)

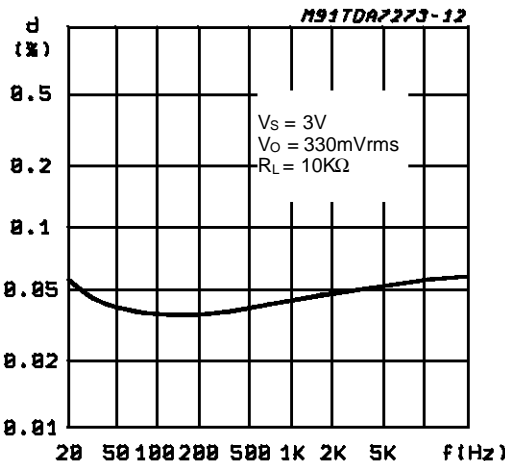

Figure 7: Supply Voltage Rejection vs. Frequency (PREAMPLIFIER)

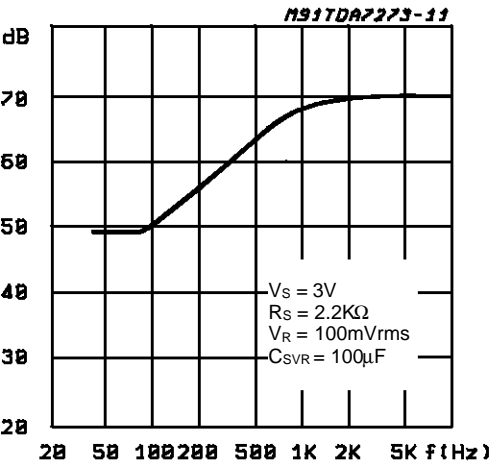

Figure 8: Quiescent Output Voltage vs. Supply Voltage (DRIVER)

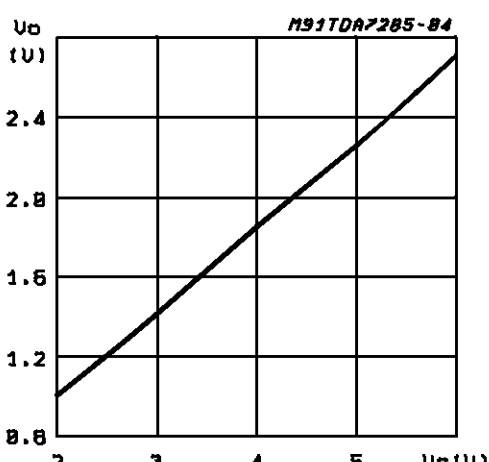

Figure 9: Closed Loop Gain vs. Frequency (DRIVER)

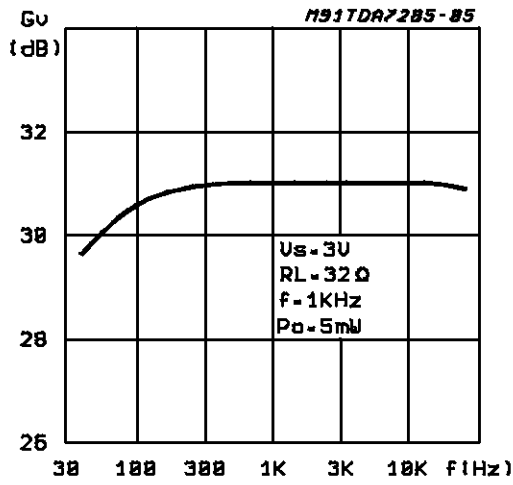

Figure 10: Output Power vs. Supply Voltage (DRIVER)

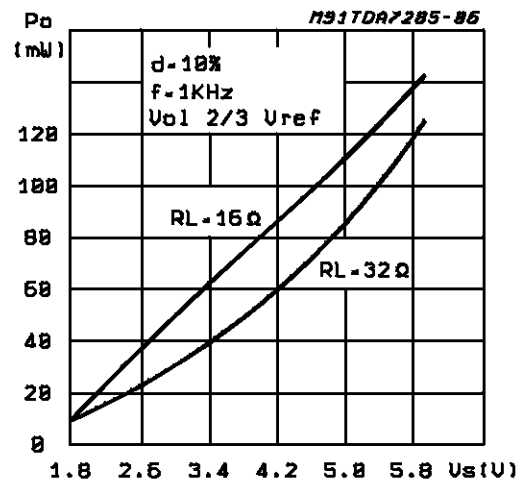

Figure 11: Distortion vs. Output Power (DRIVER)

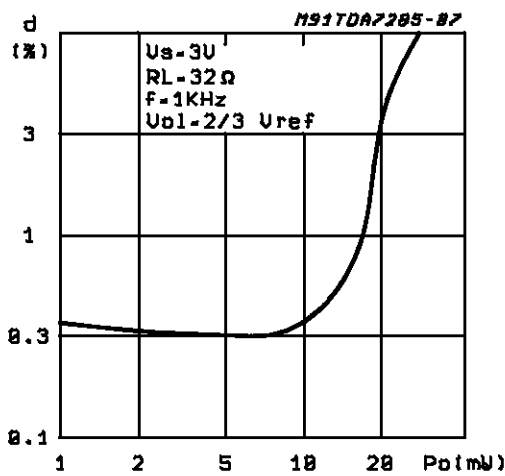

Figure 12: Distortion vs. Frequency (DRIVER)

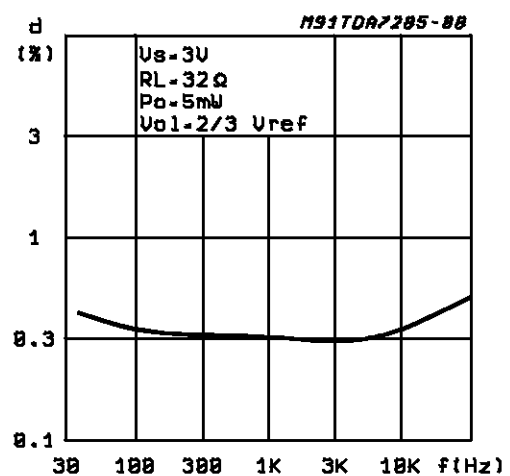

Figure 13: Supply Voltage Rejection vs. Frequency (DRIVER)

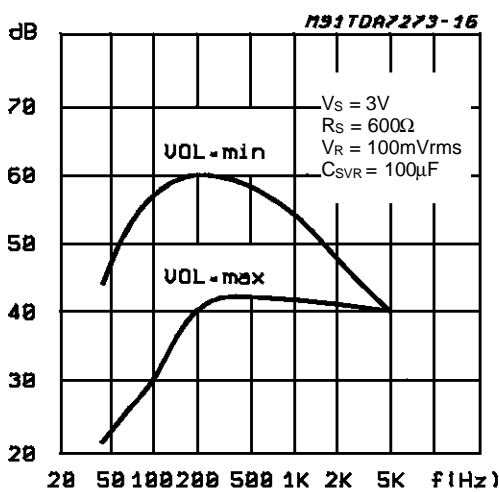

Figure 14: Volume Control (0dB = 10mW; Vs = 3V; Rvol = 50KΩ; RL = 32Ω; f = 1KHz) (DRIVER)

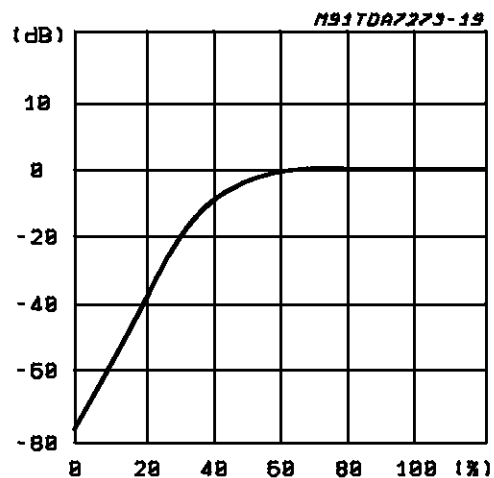

Figure 15: Reference Voltage (Pin 12) vs. Supply Voltage (MOTOR)

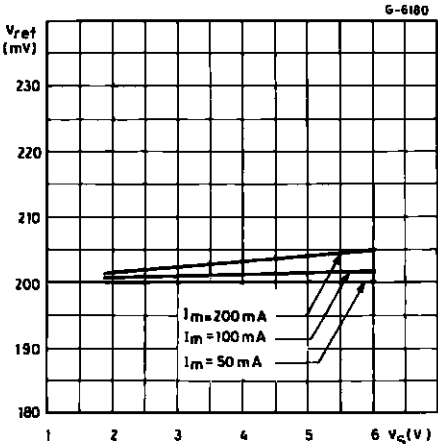

Figure 16: Shunt Ratio vs. Supply Voltage (MOTOR)

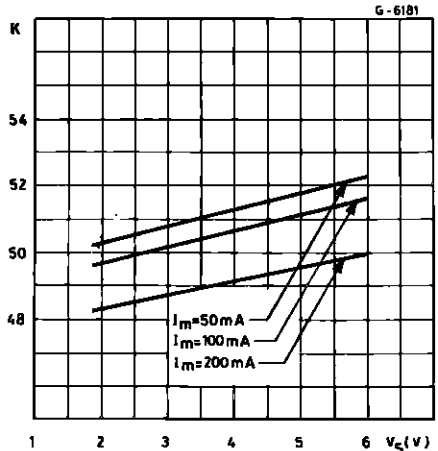

Figure 17: Surt Ratio vs. Load Current (MOTOR)

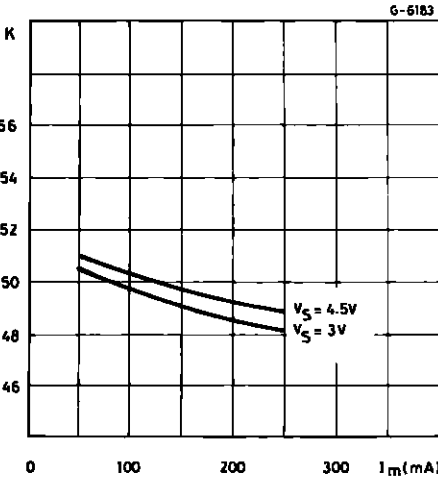

Figure 18: Saturation Voltage vs. Load Current (MOTOR)

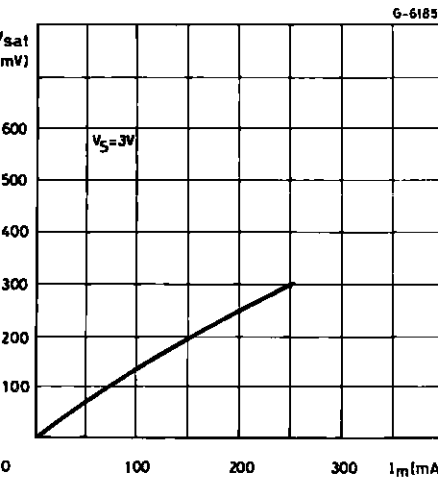

Figure 19: Speed Variations vs. Supply Voltage (MOTOR)

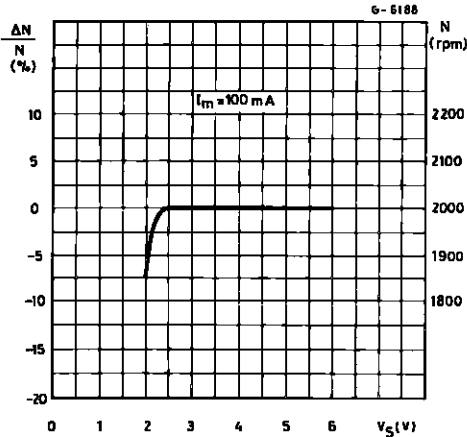
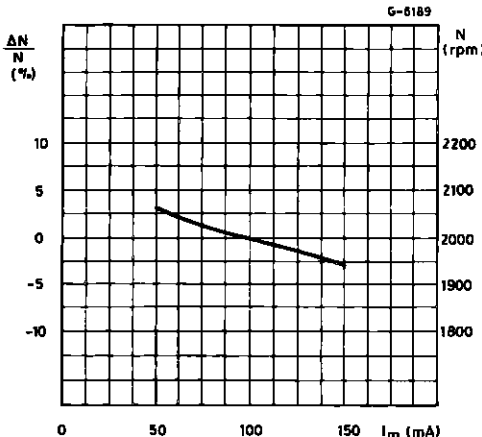
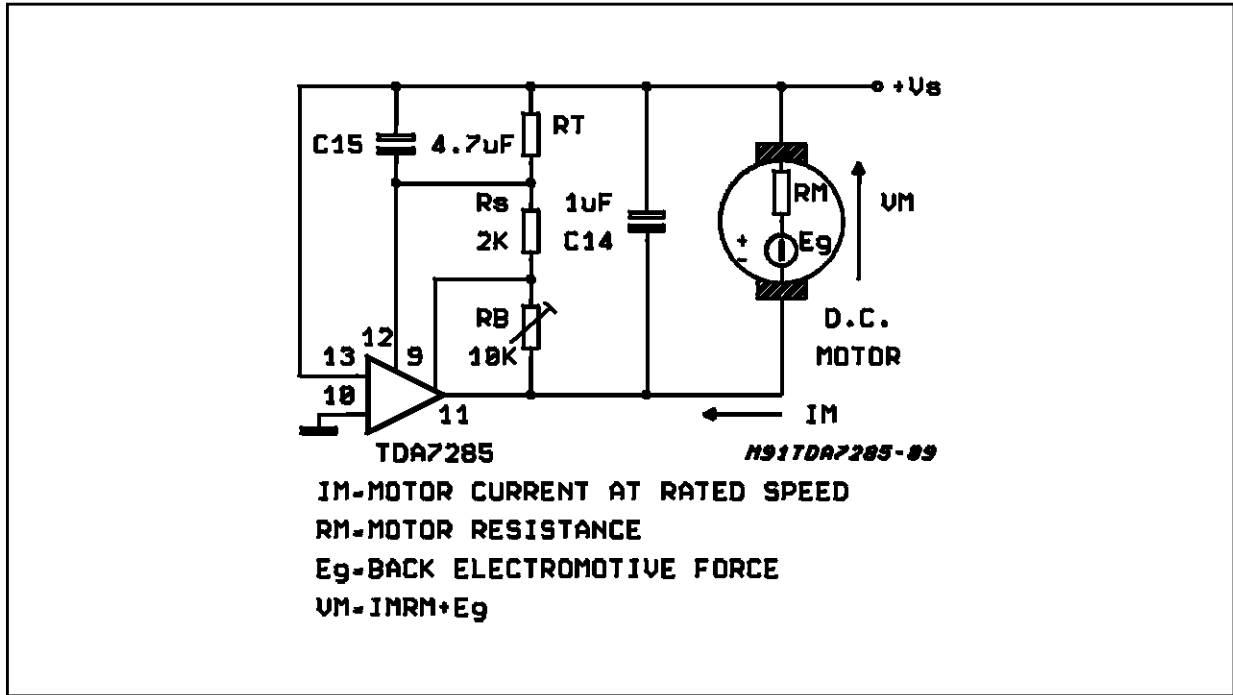

Figure 20: Speed Variations vs. Motor Current (MOTOR)



APPLICATION INFORMATION

Figure 21.



$$E_g = R_T I_d + I_M \left(\frac{R_T}{K} - R_M \right) + V_{ref} \left[1 + \frac{R_b}{R_s} + \frac{R_T}{R_s} \left(1 + \frac{1}{K} \right) \right]$$

R_s has to be adjusted so that the applied voltage V_M is suitable for a given motor, the speed is then linearly adjustable varying R_B .

The value R_T is calculated so that
 $R_{T(max.)} > K_{(min.)} * R_{M(min.)}$
 if $R_{T(max.)} > K * R_M$, instability may occur.
 The values of C_{15} ($4.7\mu F$ typ.) and C_{14} ($1\mu F$ typ.) depend on the type of motor used. C_{15} adjusts WOW and flutter of the system. C_{14} suppresses motor spikes.

SO20 PACKAGE MECHANICAL DATA

DIM.	mm			inch		
	MIN.	TYP.	MAX.	MIN.	TYP.	MAX.
A			2.65			0.104
a1	0.1		0.3	0.004		0.012
a2			2.45			0.096
b	0.35		0.49	0.014		0.019
b1	0.23		0.32	0.009		0.013
C		0.5			0.020	
c1	45 (typ.)					
D	12.6		13.0	0.496		0.512
E	10		10.65	0.394		0.419
e		1.27			0.050	
e3		11.43			0.450	
F	7.4		7.6	0.291		0.299
L	0.5		1.27	0.020		0.050
M			0.75			0.030
S	8 (max.)					

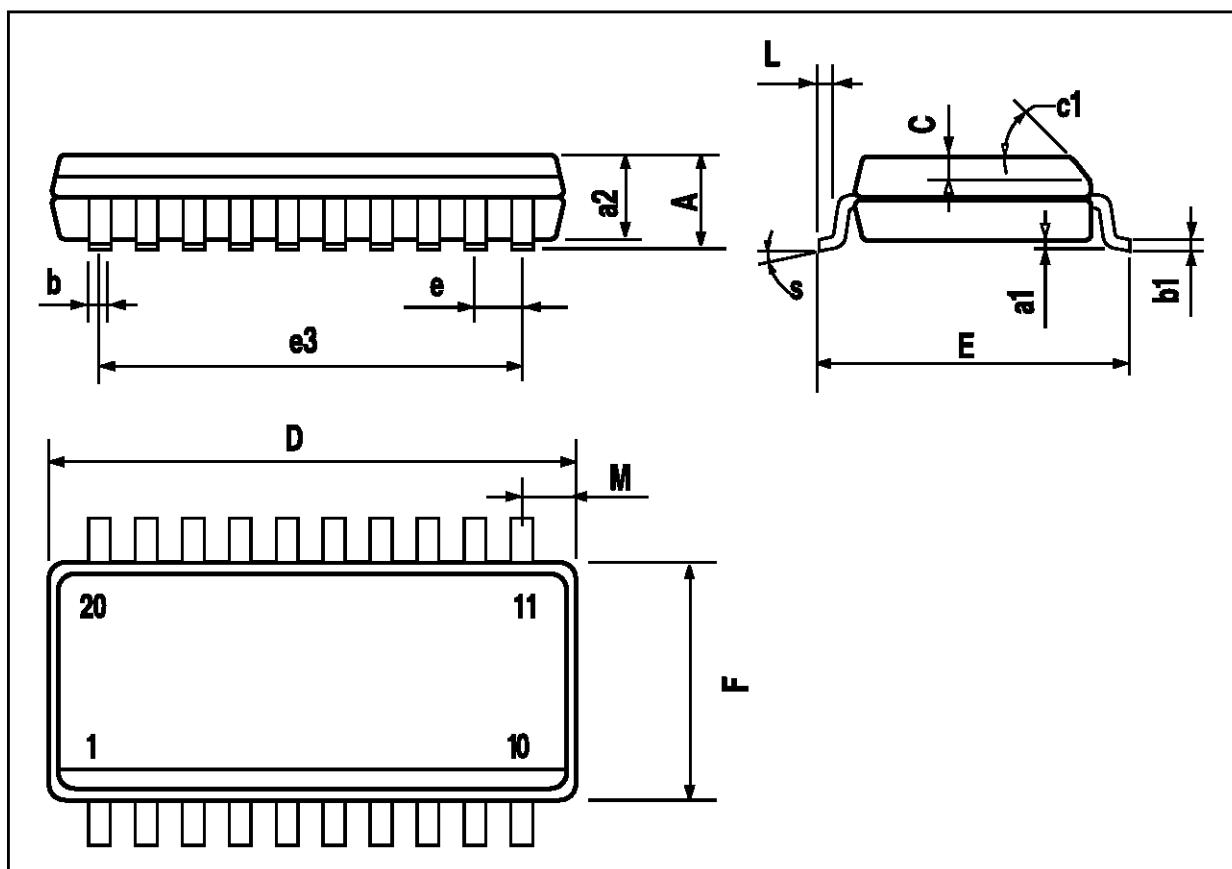

DIP20 PACKAGE MECHANICAL DATA

DIM.	mm			inch		
	MIN.	TYP.	MAX.	MIN.	TYP.	MAX.
a1	0.254			0.010		
B	1.39		1.65	0.055		0.065
b		0.45			0.018	
b1		0.25			0.010	
D			25.4			1.000
E		8.5			0.335	
e		2.54			0.100	
e3		22.86			0.900	
F			7.1			0.280
l			3.93			0.155
L		3.3			0.130	
Z			1.34			0.053

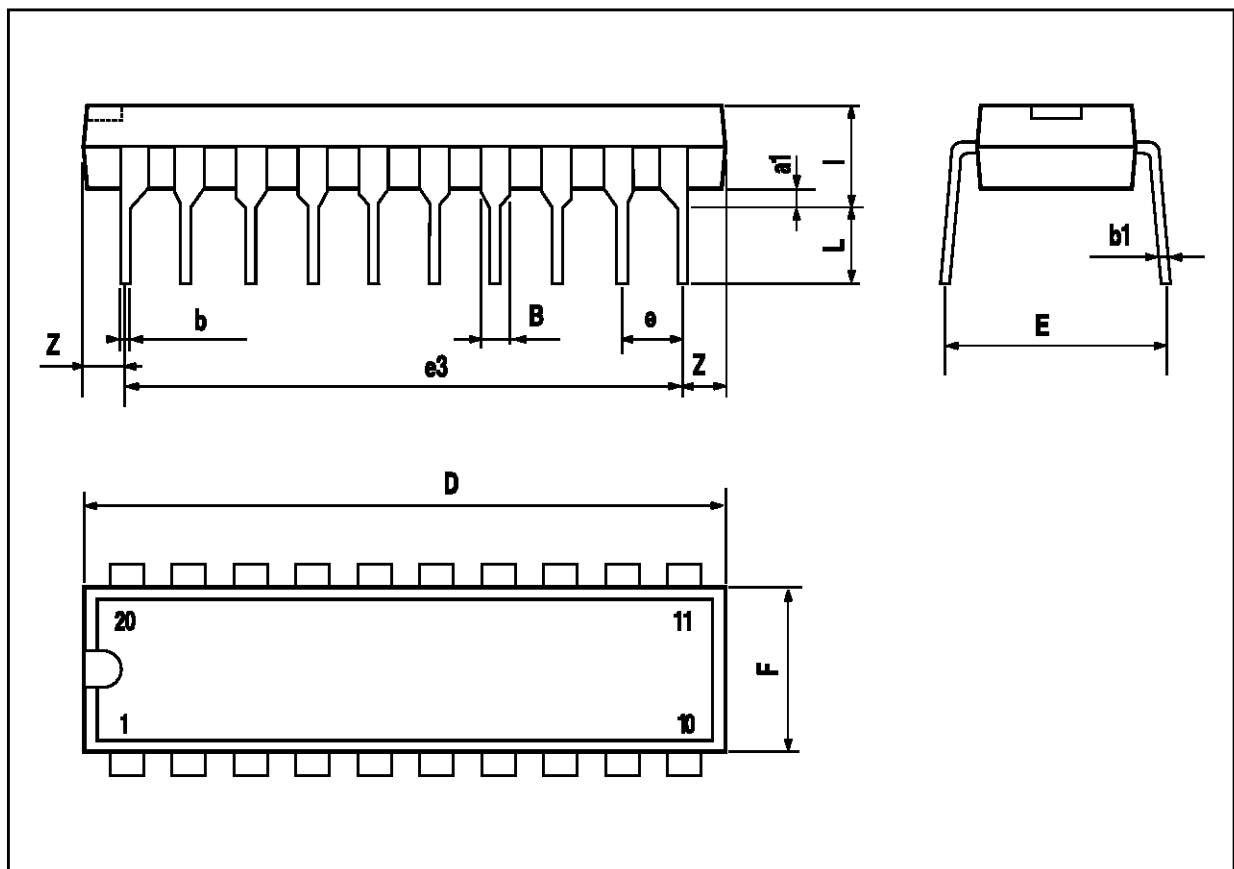

Information furnished is believed to be accurate and reliable. However, SGS-THOMSON Microelectronics assumes no responsibility for the consequences of use of such information nor for any infringement of patents or other rights of third parties which may result from its use. No license is granted by implication or otherwise under any patent or patent rights of SGS-THOMSON Microelectronics. Specification mentioned in this publication are subject to change without notice. This publication supersedes and replaces all information previously supplied. SGS-THOMSON Microelectronics products are not authorized for use as critical components in life support devices or systems without express written approval of SGS-THOMSON Microelectronics.

© 1997 SGS-THOMSON Microelectronics – Printed in Italy – All Rights Reserved

SGS-THOMSON Microelectronics GROUP OF COMPANIES

Australia - Brazil - Canada - China - France - Germany - Hong Kong - Italy - Japan - Korea - Malaysia - Malta - Morocco - The Netherlands - Singapore - Spain - Sweden - Switzerland - Taiwan - Thailand - United Kingdom - U.S.A.