

Transmissive Optical Sensor with Phototransistor Output

Description

This device has a compact construction where the emitting-light sources and the detectors are located face-to-face on the same optical axis.

The operating wavelength is 950 nm. The detector consists of a phototransistor.

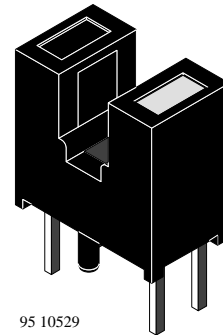

Applications

- Position sensor for shaft encoder
- Detection of opaque material such as paper, IBM cards, magnetic tapes etc.
- Limit switch for mechanical motions in VCR
- General purpose – wherever the space is limited
- End of tape, begin of tape in streamer

Features

- Gap 3 mm
- Package height: 8 mm
- Plastic polycarbonate housing
- Ambient light protected

Pin Connection

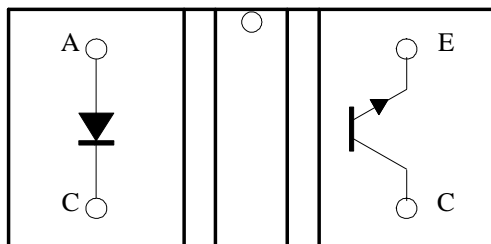

96 11970

Absolute Maximum Ratings

Input (Emitter)

Parameters	Test Conditions	Symbol	Value	Unit
Reverse voltage		V_R	6	V
Forward current		I_F	60	mA
Forward surge current	$t_p \leq 10 \mu s$	I_{FSM}	3	A
Power dissipation	$T_{amb} \leq 25^\circ C$	P_v	100	mW
Junction temperature		T_j	100	$^\circ C$

Output (Detector)

Parameters	Test Conditions	Symbol	Value	Unit
Collector emitter voltage		V_{CEO}	70	V
Emitter collector voltage		V_{ECO}	7	V
Collector current		I_C	100	mA
Power dissipation	$T_{amb} \leq 25^\circ C$	P_v	150	mW
Junction temperature		T_j	100	$^\circ C$

Coupler

Parameters	Test Conditions	Symbol	Value	Unit
Total power dissipation	$T_{amb} \leq 25^\circ C$	P_{tot}	250	mW
Operation temperature range		T_{amb}	-25 to +85	$^\circ C$
Storage temperature range		T_{stg}	-25 to +100	$^\circ C$
Soldering temperature	1.6 mm from case, $t \leq 10 s$	T_{sd}	260	$^\circ C$

Electrical Characteristics

$T_{amb} = 25^\circ C$

Input (Emitter)

Parameters	Test Conditions	Symbol	Min.	Typ.	Max.	Unit
Forward voltage	$I_F = 60 mA$	V_F		1.25	1.5	V
Breakdown voltage	$I_R = 100 \mu A$	$V_{(BR)}$	6			V
Junction capacitance	$V_R = 0, f = 1 MHz$	C_j		50		pF

Output (Detector)

Parameters	Test Conditions	Symbol	Min.	Typ.	Max.	Unit
Collector emitter voltage	$I_C = 1 mA$	V_{CEO}	70			V
Emitter collector voltage	$I_E = 10 \mu A$	V_{ECO}	7			V
Collector dark current	$V_{CE} = 25 V, I_F = 0, E = 0$	I_{CEO}		10	100	nA

Coupler

Parameters	Test Conditions	Symbol	Min.	Typ.	Max.	Unit
Collector current	$V_{CE} = 5 V, I_F = 10 A$	I_C	1.2	2.4		mA
Collector emitter saturation voltage	$I_F = 10 mA, I_C = 1 mA$	V_{CEsat}			0.8	V

Switching Characteristics

See test circuit

Parameters	Test Conditions	Symbol	Min.	Typ.	Max.	Unit
Turn-on time	$I_C = 1 \text{ mA}$, $V_{CE} = 5 \text{ V}$, $R_L = 100 \Omega$	t_{on}		15		μs
Turn-off time	$I_C = 1 \text{ mA}$, $V_{CE} = 5 \text{ V}$, $R_L = 100 \Omega$	t_{off}		10		μs

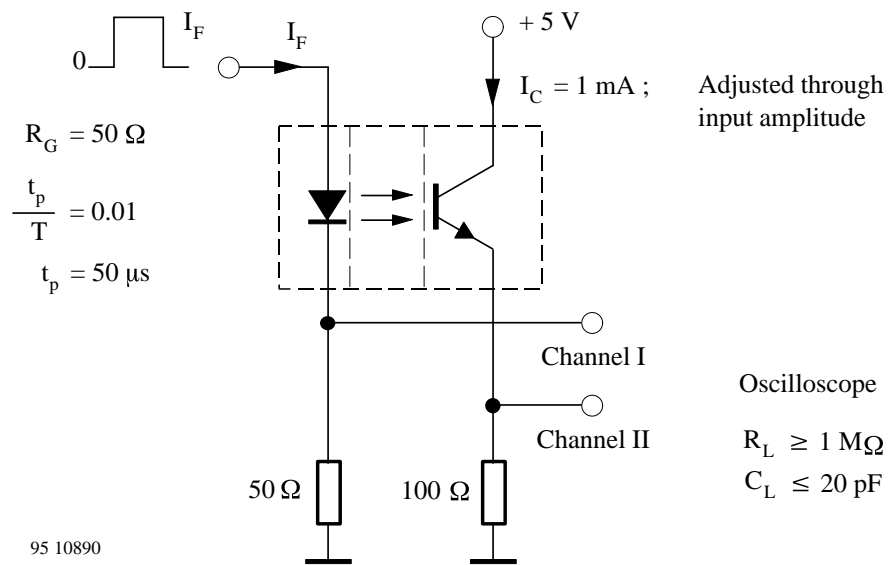

Figure 1. Test circuit

Typical Characteristics ($T_{amb} = 25^{\circ}\text{C}$, unless otherwise specified)

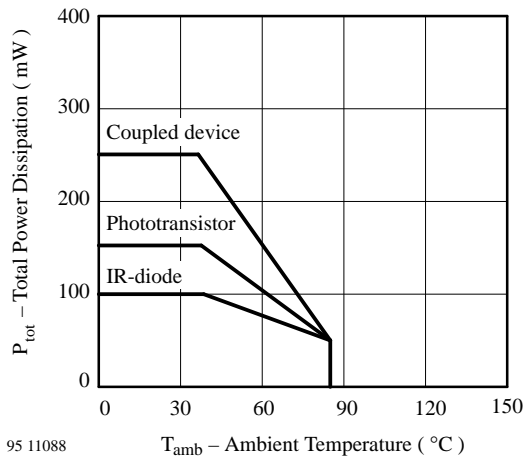

Figure 2. Total Power Dissipation vs. Ambient Temperature

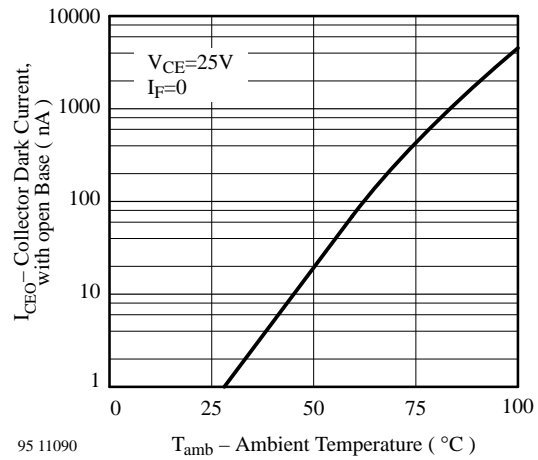

Figure 5. Collector Dark Current vs. Ambient Temperature

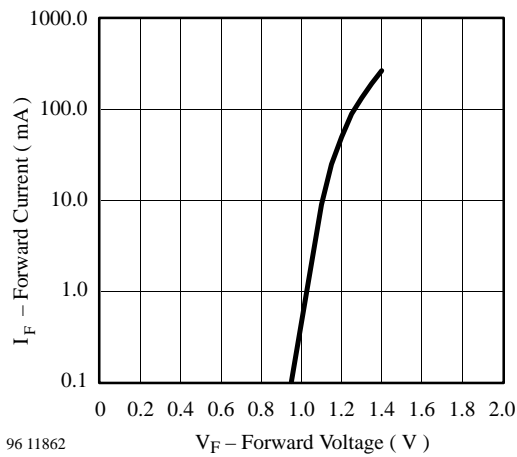

Figure 3. Forward Current vs. Forward Voltage

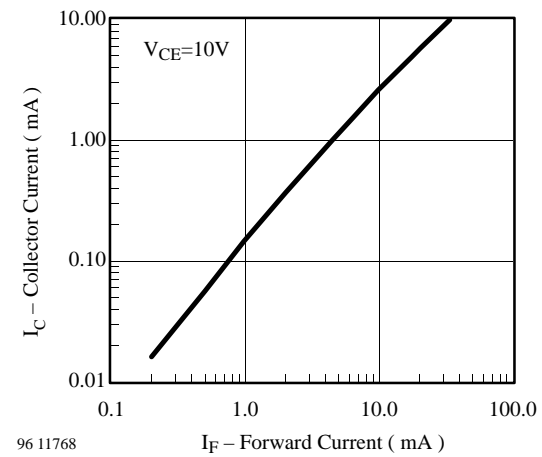

Figure 6. Collector Current vs. Forward Current

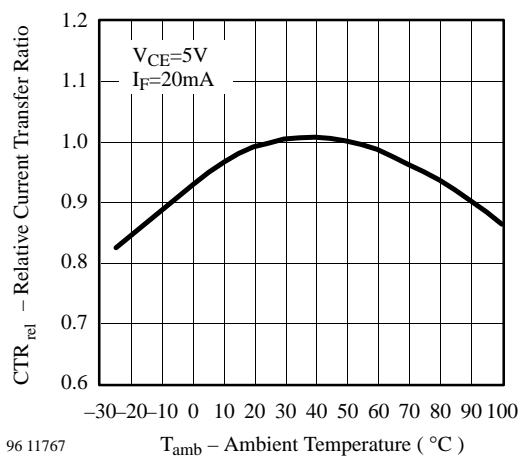

Figure 4. Rel. Current Transfer Ratio vs. Ambient Temperature

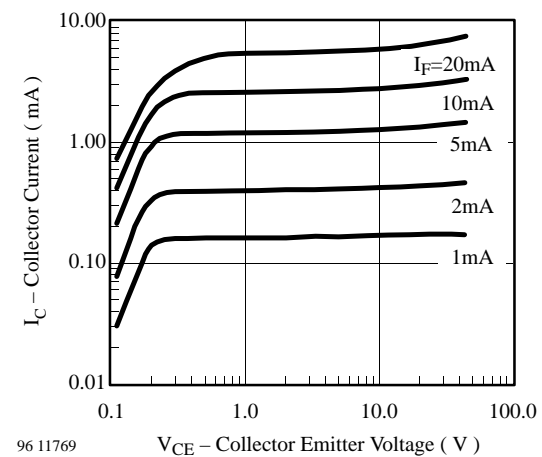

Figure 7. Collector Current vs. Collector Emitter Voltage

Typical Characteristics ($T_{amb} = 25^{\circ}\text{C}$, unless otherwise specified)

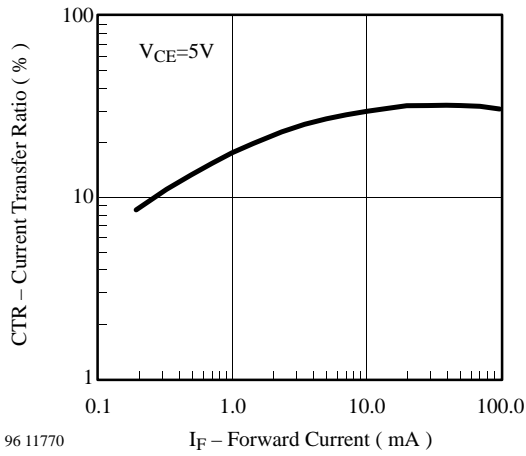

Figure 8. Current Transfer Ratio vs. Forward Current

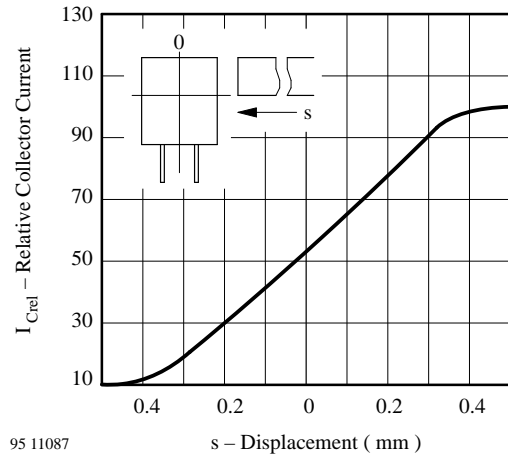

Figure 10. Relative Collector Current vs. Displacement

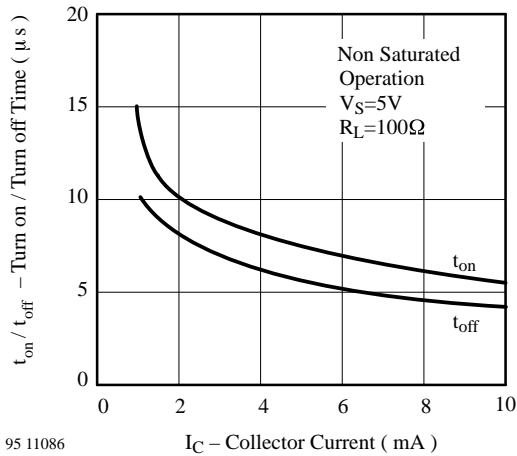
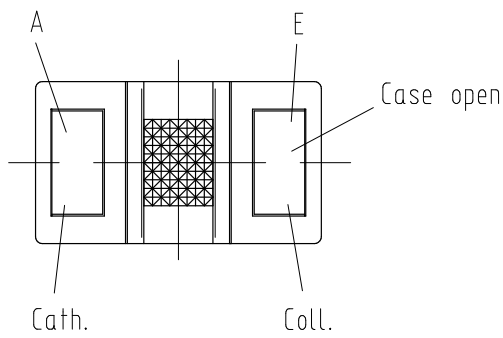
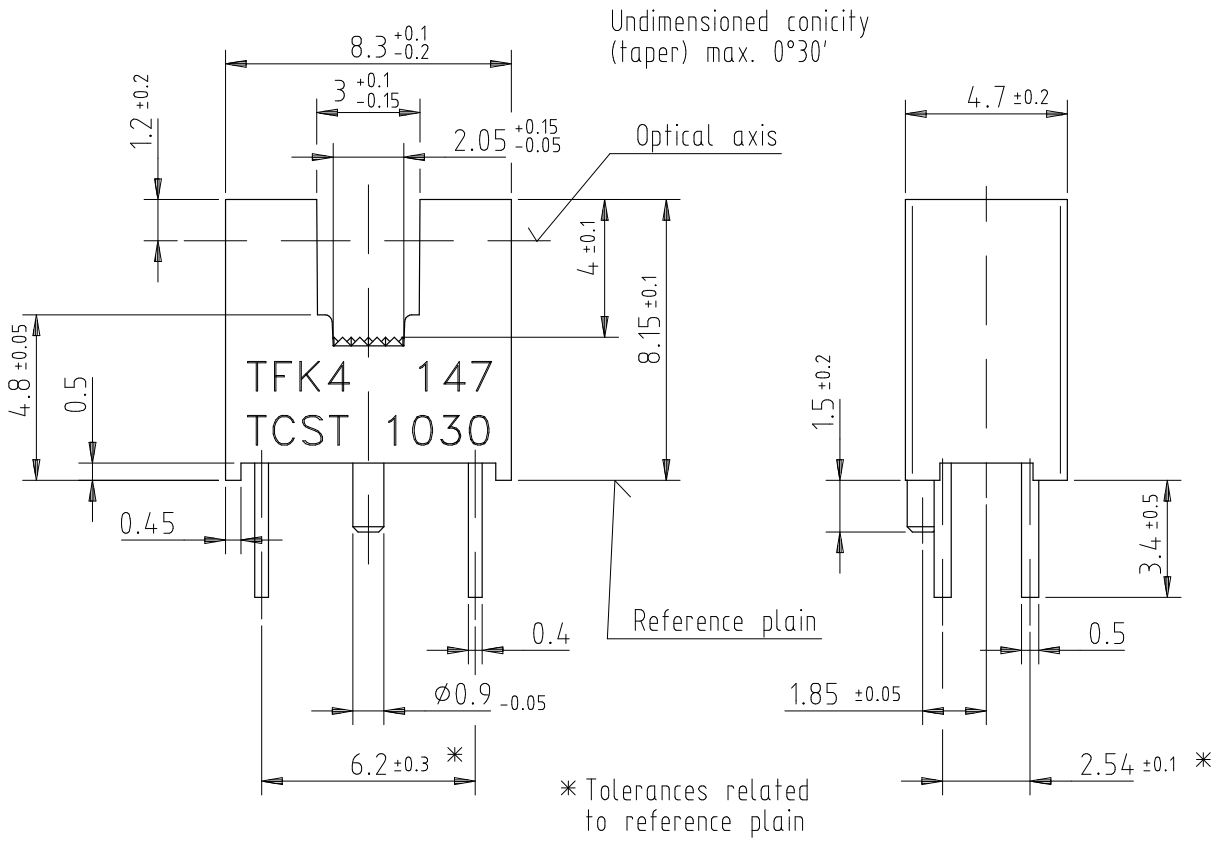

Figure 9. Turn on / off Time vs. Collector Current

Dimensions in mm



technical drawings according to DIN specifications

96 12074

Ozone Depleting Substances Policy Statement

It is the policy of **TEMIC TELEFUNKEN microelectronic GmbH** to

1. Meet all present and future national and international statutory requirements.
2. Regularly and continuously improve the performance of our products, processes, distribution and operating systems with respect to their impact on the health and safety of our employees and the public, as well as their impact on the environment.

It is particular concern to control or eliminate releases of those substances into the atmosphere which are known as ozone depleting substances (ODSs).

The Montreal Protocol (1987) and its London Amendments (1990) intend to severely restrict the use of ODSs and forbid their use within the next ten years. Various national and international initiatives are pressing for an earlier ban on these substances.

TEMIC TELEFUNKEN microelectronic GmbH semiconductor division has been able to use its policy of continuous improvements to eliminate the use of ODSs listed in the following documents.

1. Annex A, B and list of transitional substances of the Montreal Protocol and the London Amendments respectively
2. Class I and II ozone depleting substances in the Clean Air Act Amendments of 1990 by the Environmental Protection Agency (EPA) in the USA
3. Council Decision 88/540/EEC and 91/690/EEC Annex A, B and C (transitional substances) respectively.

TEMIC can certify that our semiconductors are not manufactured with ozone depleting substances and do not contain such substances.

We reserve the right to make changes to improve technical design and may do so without further notice.

Parameters can vary in different applications. All operating parameters must be validated for each customer application by the customer. Should the buyer use TEMIC products for any unintended or unauthorized application, the buyer shall indemnify TEMIC against all claims, costs, damages, and expenses, arising out of, directly or indirectly, any claim of personal damage, injury or death associated with such unintended or unauthorized use.

TEMIC TELEFUNKEN microelectronic GmbH, P.O.B. 3535, D-74025 Heilbronn, Germany
Telephone: 49 (0)7131 67 2831, Fax number: 49 (0)7131 67 2423