

Reflecting small LEDs, directly mountable ($\phi 3.2$ mm)

SLR-325 Series

The SLR-325 series are small 3.2 mm LEDs with a lead pitch of 5 mm which can be directly mounted on a printed circuit board. Two colors and four lens types are available for a total of eight types, and they are suitable for use in a wide variety of applications.

●Features

- 1) Can be directly mounted on a printed circuit board.
- 2) Available on tape to allow mounting using a 5 mm pitch machine without lead forming.
- 3) A low overall height of 5.5 mm makes it possible to design a slim unit.
- 4) Large flange eliminates wobbling after mounting (stable before and after soldering).
- 5) LED arrays at a conventional 4 mm pitch are also possible.
- 6) High reliability.

●Selection guide

Emitting color Lens	Red	Orange	Yellow	Green
	Colored diffused	SLR-325VR	SLR-325DU	SLR-325YY
Colored clear	SLR-325VC	SLR-325DC	SLR-325YC	SLR-325MC

Note: This product is only available on tape.

●Absolute maximum ratings ($T_a = 25^\circ\text{C}$)

Parameter	Symbol	Red	Orange	Yellow	Green	Unit
		SLR-325VR SLR-325VC	SLR-325DU SLR-325DC	SLR-325YY SLR-325YC	SLR-325MG SLR-325MC	
Power dissipation	P_D	60	60	60	75	mW
Forward current	I_F	20	20	20	25	mA
Peak forward current	I_{FP}	60*	60*	60*	60*	mA
Reverse voltage	V_R	3	3	3	3	V
Operating temperature	T_{opr}	-25~+85				$^\circ\text{C}$
Storage temperature	T_{stg}	-30~+100				$^\circ\text{C}$
Soldering temperature	—	260 $^\circ\text{C}$ 5seconds maximum				—

* Pulse width 1ms Duty 1 / 5

●External dimensions (Units: mm)

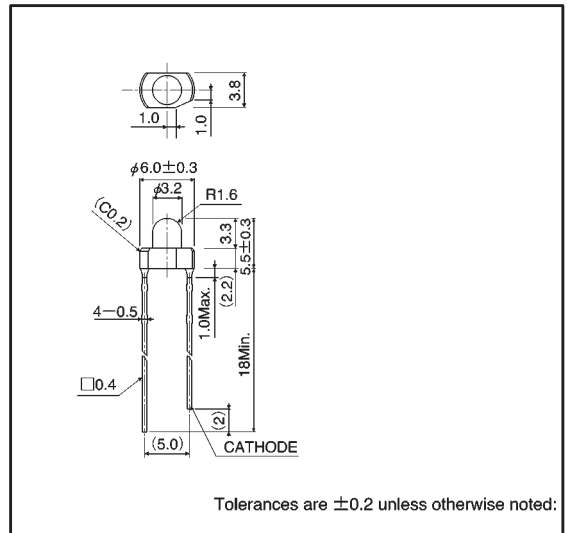

●Electrical and optical characteristics (Ta = 25°C)

Parameter	Symbol	Conditions	Red			Orange			Yellow			Green			Unit
			Min.	Typ.	Max.	Min.	Typ.	Max.	Min.	Typ.	Max.	Min.	Typ.	Max.	
Forward voltage	V _F	I _F =10mA	—	2.0	3.0	—	2.0	3.0	—	2.1	3.0	—	2.1	3.0	V
Reverse current	I _R	V _R =3V	—	—	10	—	—	10	—	—	10	—	—	10	μA
Peak wavelength	λ _P	I _F =10mA	—	650	—	—	610	—	—	585	—	—	563	—	nm
Spectral line half width	Δλ	I _F =10mA	—	40	—	—	40	—	—	40	—	—	40	—	nm
Viewing angle	2θ _{1/2}	Diffused	—	40	—	—	40	—	—	40	—	—	40	—	deg
		Transparent	—	40	—	—	40	—	—	40	—	—	40	—	

●Luminous intensity vs. wavelength

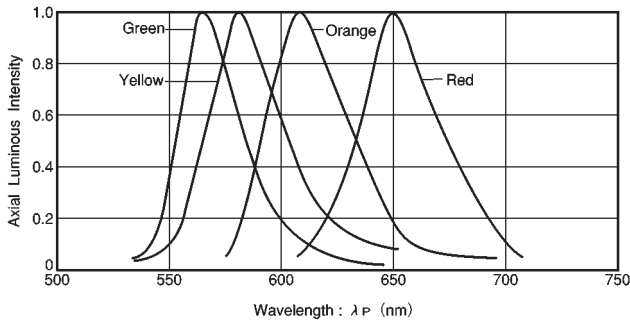

Fig.1

●Luminous intensity

Color	λ _P	Type	Min.	Typ.	Max.	Unit
Red	650	SLR-325VR	3.6	10	—	mcd
		SLR-325VC	5.6	16.0	—	mcd
Orange	610	SLR-325DU	3.6	10	—	mcd
		SLR-325DC	5.6	16.0	—	mcd
Yellow	585	SLR-325YY	2.2	6.3	—	mcd
		SLR-325YC	5.6	16.0	—	mcd
Green	563	SLR-325MG	5.6	16.0	—	mcd
		SLR-325MC	9.0	25.0	—	mcd

Note: Measured at I_F = 10 mA

●Directional pattern

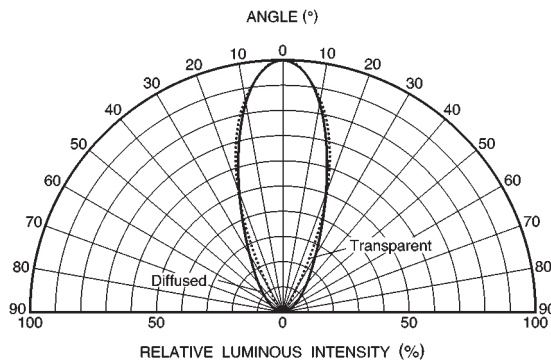

Fig. 2

●Electrical characteristic curves 1 (red)

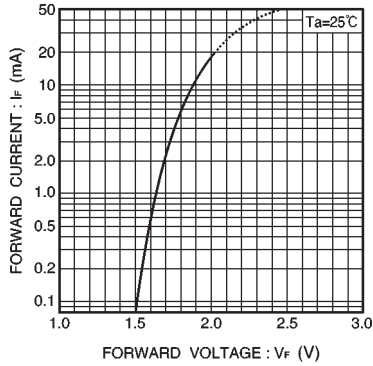

Fig. 3 Forward current vs. forward voltage

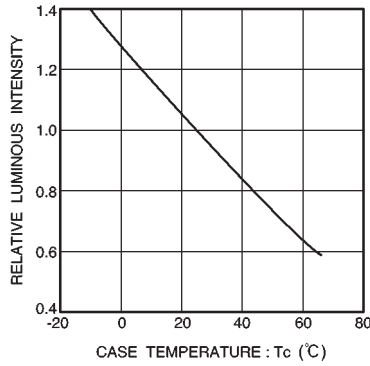

Fig. 4 Luminous intensity vs. case temperature

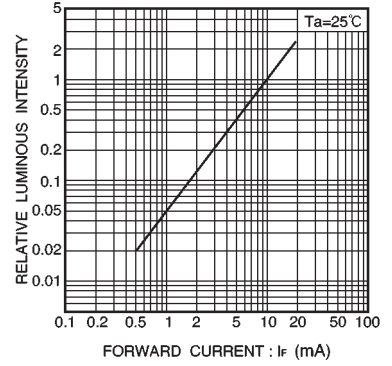

Fig. 5 Luminous intensity vs. forward current

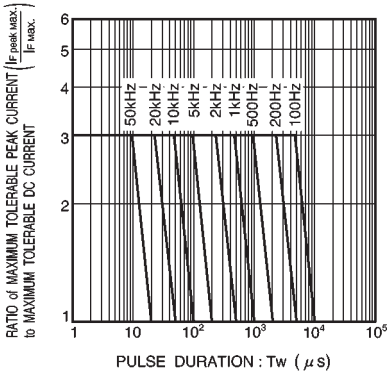

Fig. 6 Maximum tolerable peak current vs. pulse duration

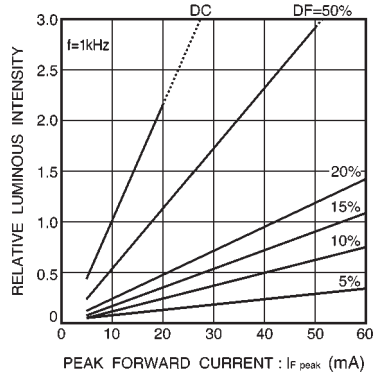

Fig. 7 Luminous intensity vs. peak forward current

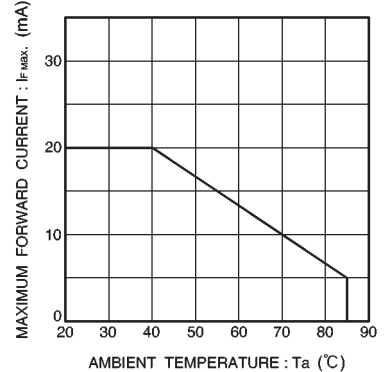

Fig. 8 Maximum forward current vs. ambient temperature

●Electrical characteristic curves 2 (orange)

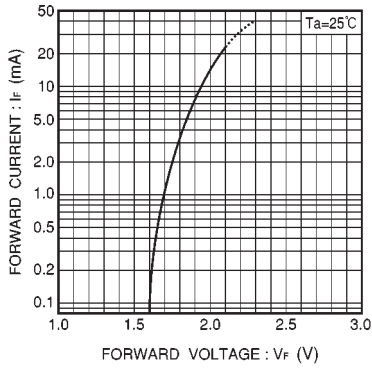

Fig.9 Forward current vs. forward voltage

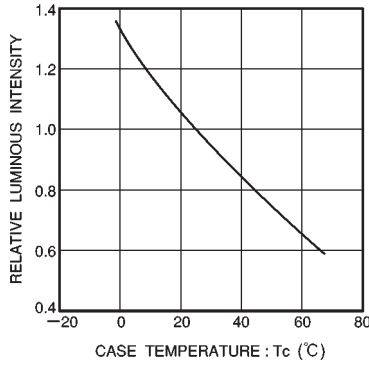

Fig.10 Luminous intensity vs. case temperature

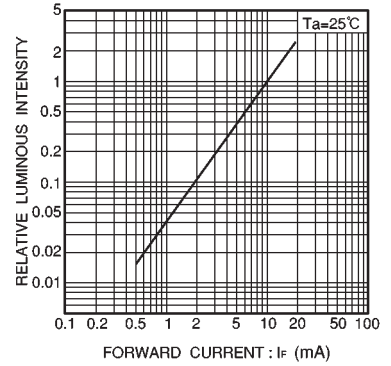

Fig.11 Luminous intensity vs. forward current

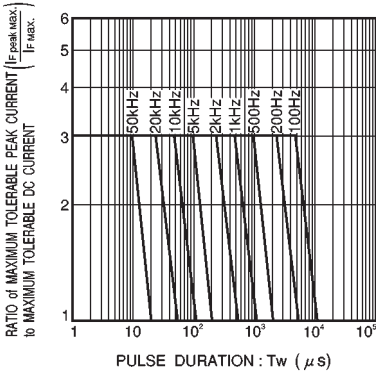

Fig.12 Maximum tolerable peak current vs. pulse duration

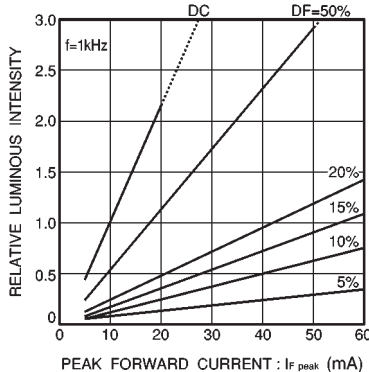

Fig.13 Luminous intensity vs. peak forward current

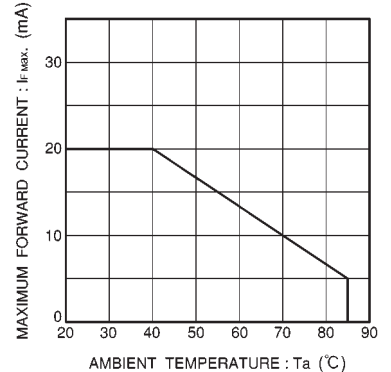

Fig.14 Maximum forward current vs. ambient temperature

● Electrical characteristics 3 (yellow)

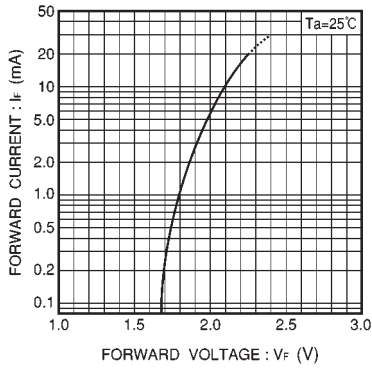

Fig.15 Forward current vs. forward voltage

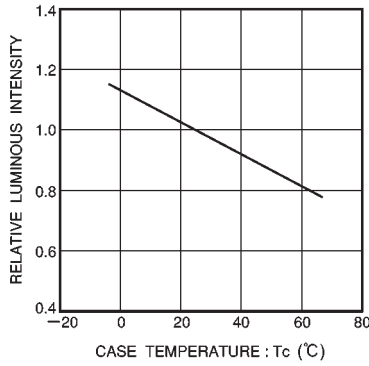

Fig.16 Luminous intensity vs. case temperature

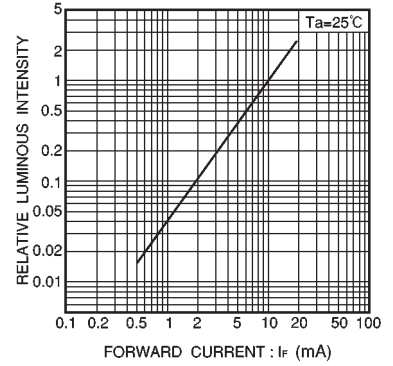

Fig.17 Luminous intensity vs. forward current

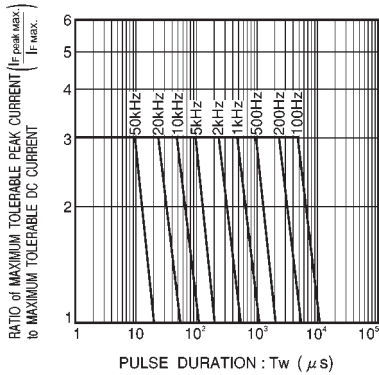

Fig.18 Maximum tolerable peak current vs. pulse duration

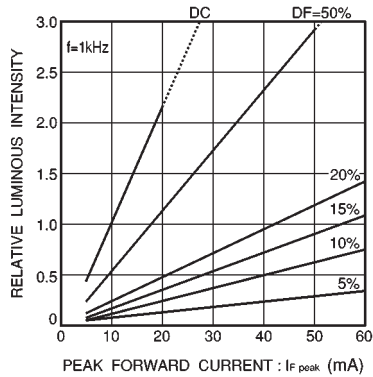

Fig.19 Luminous intensity vs. peak forward current

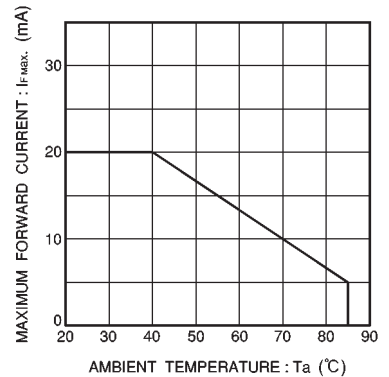

Fig.20 Maximum forward current vs. ambient temperature

●Electrical characteristic curves 4 (green)

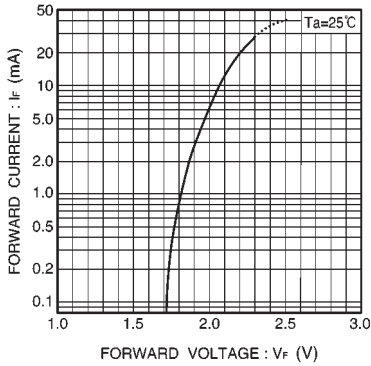

Fig. 21 Forward current vs. forward voltage

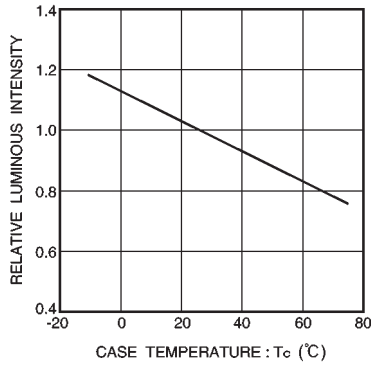

Fig. 22 Luminous intensity vs. case temperature

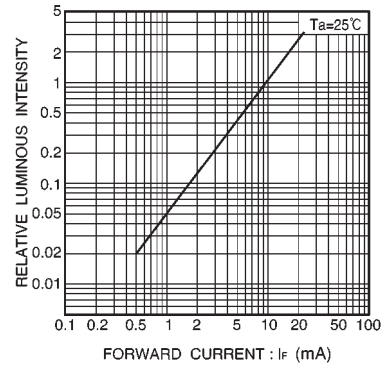

Fig. 23 Luminous intensity vs. forward current

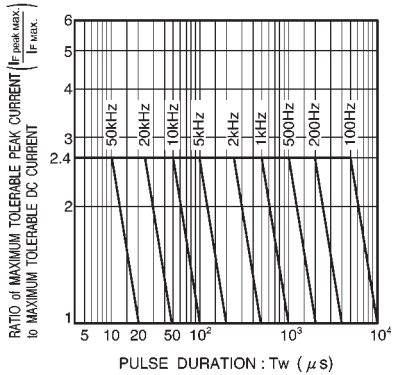

Fig. 24 Maximum tolerable peak current vs. pulse duration

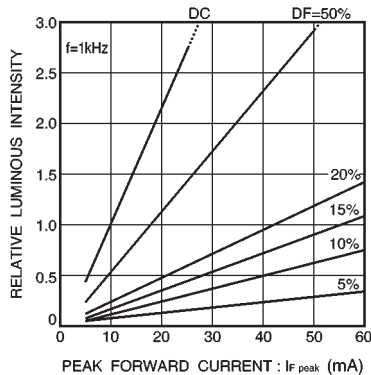

Fig. 25 Luminous intensity vs. peak forward current

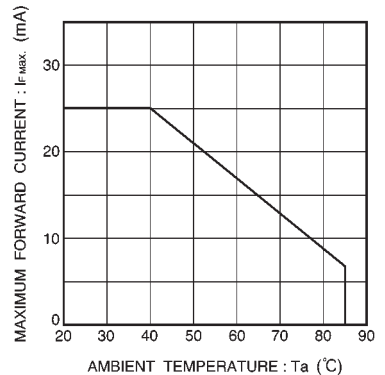

Fig. 26 Maximum forward current vs. ambient temperature