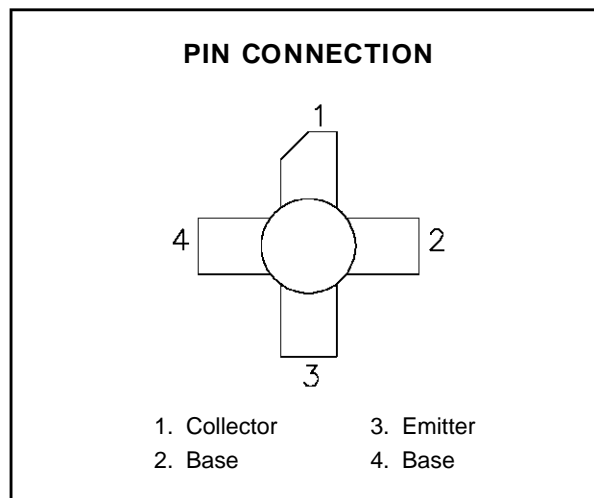
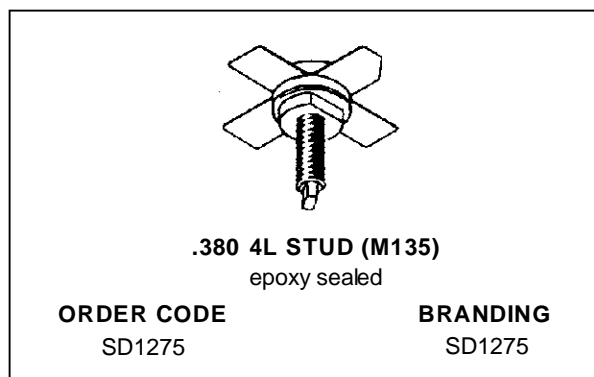

**RF & MICROWAVE TRANSISTORS
VHF MOBILE APPLICATIONS**

- 160 MHz
- 13.6 VOLTS
- COMMON EMITTER
- P_{OUT} = 40 W MIN. WITH 9.0 dB GAIN

DESCRIPTION

The SD1275 is a 13.6 V Class C epitaxial silicon NPN planar transistor designed primarily for VHF communications. The SD1275 utilizes an emitter ballasted die geometry to withstand severe load mismatch conditions.

ABSOLUTE MAXIMUM RATINGS (T_{case} = 25°C)

Symbol	Parameter	Value	Unit
V _{CB0}	Collector-Base Voltage	36	V
V _{CEO}	Collector-Emitter Voltage	16	V
V _{CES}	Collector-Emitter Voltage	36	V
V _{EBO}	Emitter-Base Voltage	4.0	V
I _c	Device Current	8.0	A
P _{DISS}	Power Dissipation	70	W
T _J	Junction Temperature	+200	°C
T _{STG}	Storage Temperature	- 65 to +150	°C

THERMAL DATA

R _{TH(j-c)}	Junction-Case Thermal Resistance	1.2	°C/W
----------------------	----------------------------------	-----	------

SD1275

ELECTRICAL SPECIFICATIONS (T_{case} = 25°C)

STATIC

Symbol	Test Conditions		Value			Unit
			Min.	Typ.	Max.	
BV _{CES}	I _C = 15mA	V _{BE} = 0mA	36	—	—	V
BV _{CEO}	I _C = 50mA	I _B = 0mA	16	—	—	V
BV _{EBO}	I _E = 5mA	I _C = 0mA	4.0	—	—	V
I _{CBO}	V _{CB} = 15V	I _E = 0mA	—	—	5	mA
h _{FE}	V _{CE} = 5V	I _C = 250mA	20	—	—	—

DYNAMIC

Symbol	Test Conditions			Value			Unit
				Min.	Typ.	Max.	
P _{OUT}	f = 160 MHz	P _{IN} = 5.0 W	V _{CE} = 13.6 V	40	—	—	W
G _P	f = 160 MHz	P _{IN} = 5.0 W	V _{CE} = 13.6 V	9	—	—	dB
C _{OB}	f = 1 MHz	V _{CB} = 15 V		—	95	—	pF

TYPICAL PERFORMANCE

POWER GAIN vs FREQUENCY

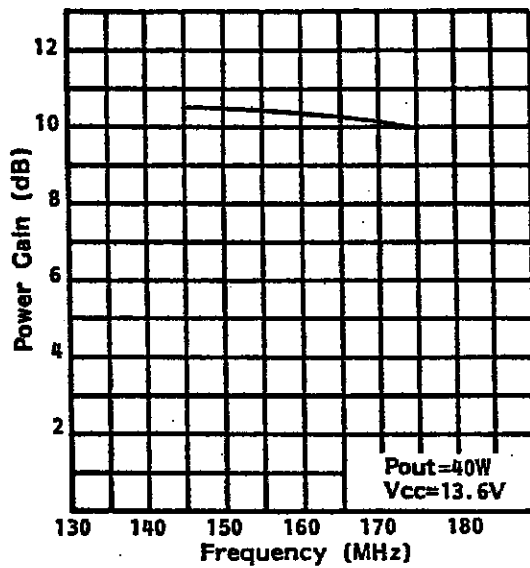

POWER OUTPUT vs POWER INPUT

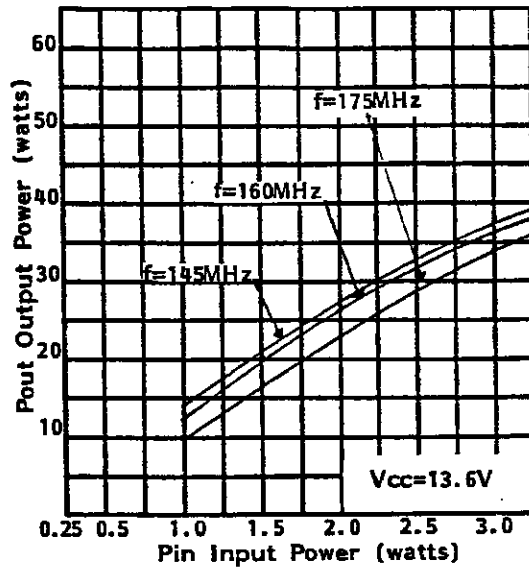

TYPICAL PERFORMANCE (cont'd)

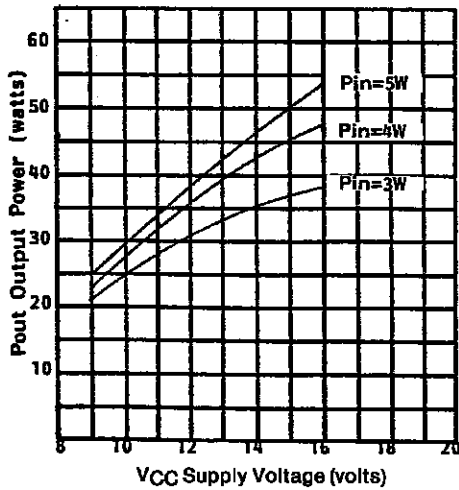
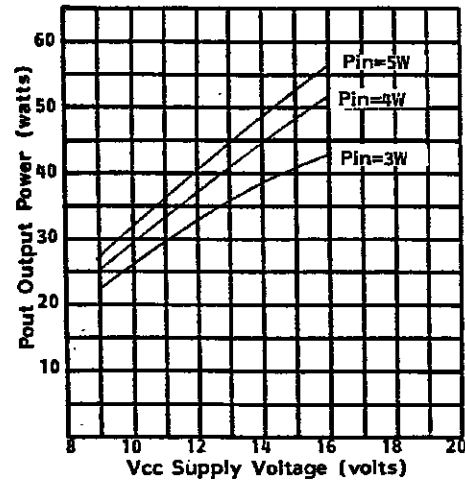
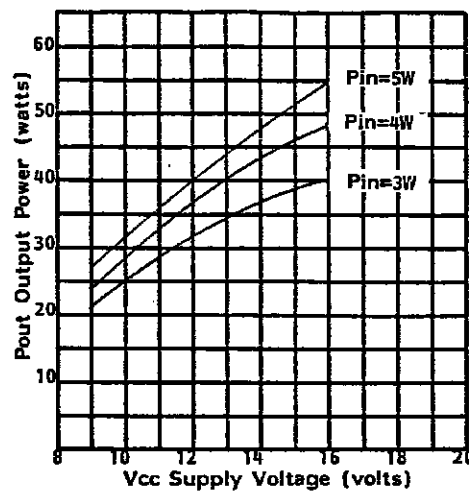
POWER OUTPUT vs SUPPLY VOLTAGE
(175 MHz)POWER OUTPUT vs SUPPLY VOLTAGE
(145 MHz)POWER OUTPUT vs SUPPLY VOLTAGE
(160 MHz)

IMPEDANCE DATA

FREQ.	Z _{IN} (Ω)	Z _{CL} (Ω)
160 MHz	1.0 + j 0.4	2.3 + j 0.1

P_{IN} = 3.0 W
V_{CE} = 12.5 V

PACKAGE MECHANICAL DATA

Ref.: Dwg. No.12-0135

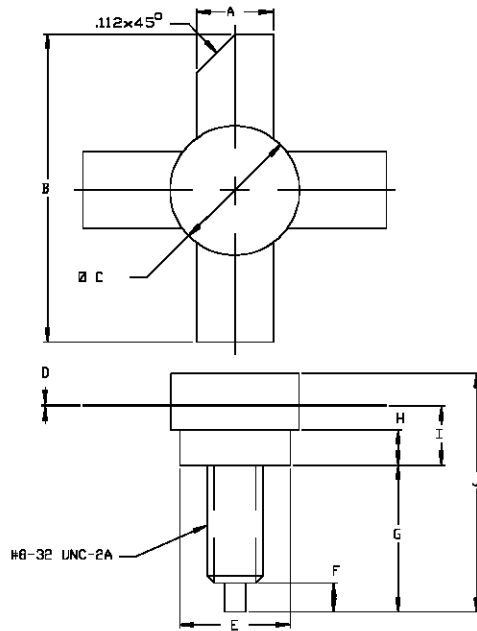

SGS-THOMSON MICROELECTRONICS		
	MINIMUM Inches/mm	MAXIMUM Inches/mm
A	.220/5,59	.230/5,84
B	.980/24,89	
C	.370/9,40	.385/9,78
D	.004/0,10	.007/0,18
E	.320/8,13	.330/8,38
F	.100/2,54	.130/3,30
G	.450/11,43	.490/12,45
H	.090/2,29	.100/2,54
I	.155/3,94	.175/4,45
J		.750/19,05

Information furnished is believed to be accurate and reliable. However, SGS-THOMSON Microelectronics assumes no responsibility for the consequences of use of such information nor for any infringement of patents or other rights of third parties which may results from its use. No license is granted by implication or otherwise under any patent or patent rights of SGS-THOMSON Microelectronics. Specifications mentioned in this publication are subject to change without notice. This publication supersedes and replaces all information previously supplied. SGS-THOMSON Microelectronics products are not authorized for use as critical components in life support devices or systems without express written approval of SGS-THOMSON Microelectronics.

© 1994 SGS-THOMSON Microelectronics - All Rights Reserved

SGS-THOMSON Microelectronics GROUP OF COMPANIES
 Australia - Brazil - France - Germany - Hong Kong - Italy - Japan - Korea - Malaysia - Malta - Morocco - The Netherlands -
 Singapore - Spain - Sweden - Switzerland - Taiwan - Thailand - United Kingdom - U.S.A