

DATA SHEET

SAA5281

**Integrated Video input processor
and Teletext decoder (IVT1.8*)**

Preliminary specification
Supersedes data of June 1994
File under Integrated Circuits, IC02

1996 Nov 04

Integrated Video input processor and Teletext decoder (IVT1.8*)

SAA5281

FEATURES

- Complete Teletext and VPS decoding in a single package
- Built-in 8K × 8 memory for up to 8 page storage
- Enhanced mode allows 7 Fasttext pages and 8 pages of TOP to be captured
- Ability to request only subtitle pages
- Acquisition and decoding of VPS data
- Data valid output available to indicate reception of error-free VPS or packet 8/30/2 data
- Software and hardware compatible with SAA5246 and SAA5248
- Meshing display within boxes
- Separate data checking algorithms and pointers for each acquisition channel
- 24 : 18 Hamming checker
- Automatic packet 26 extension character processing
- Indication of Line 23 for external use
- 13.5 MHz clock output to drive external microcontroller
- Detection of Spanish transmissions to disable flicker-stopper
- Compatible with Philips' one-chip TV IC (TDA836X) for scan-locking applications.



DESCRIPTION

The IVT1.8* is a single-chip Teletext decoder IC for decoding 625-line based World System Teletext transmissions. The device is based on IVT1.0VPS and has reception facilities for the 5 MHz biphasic VPS signal. It is intended for use in video recorders, in particular to implement the VPT facility (VCR programming via Teletext). With suitable software both VPT standards (EBU PDC System A and System B) can be accommodated to allow operation from any European VPT transmission. Automatic processing of packet 26 transmissions is also possible. No external memory is required as an 8K × 8 DRAM is included on-chip for up to 8 page storage. An enhanced mode allows 7 Fasttext pages to be stored, with one chapter used to store extension packets.

QUICK REFERENCE DATA

SYMBOL	PARAMETER	MIN.	TYP.	MAX.	UNIT
V _{DD}	supply voltage	4.5	5.0	5.5	V
I _{DD}	supply current	–	75	150	mA
V _{sync}	sync voltage amplitude	0.1	0.3	0.6	V
V _{vid(p-p)}	video input voltage amplitude (peak-to-peak value)	0.7	1.0	1.4	V
f _{xtal}	crystal frequency	–	27	–	MHz
T _{amb}	operating ambient temperature	–20	–	+70	°C

ORDERING INFORMATION

TYPE NUMBER	PACKAGE		
	NAME	DESCRIPTION	VERSION
SAA5281P	DIP48	plastic shrink dual in-line package; 32 leads (400 mil)	SOT240-1
SAA5281ZP	SDIP52	plastic shrink dual in-line package; 52 leads (600 mil)	SOT247-1
SAA5281GP	QFP64	plastic quad flat package; 64 leads (lead length 1.95 mm); body 14 × 20 × 2.8 mm	SOT319-2

Integrated Video input processor and Teletext decoder (IVT1.8*)

SAA5281

BLOCK DIAGRAM

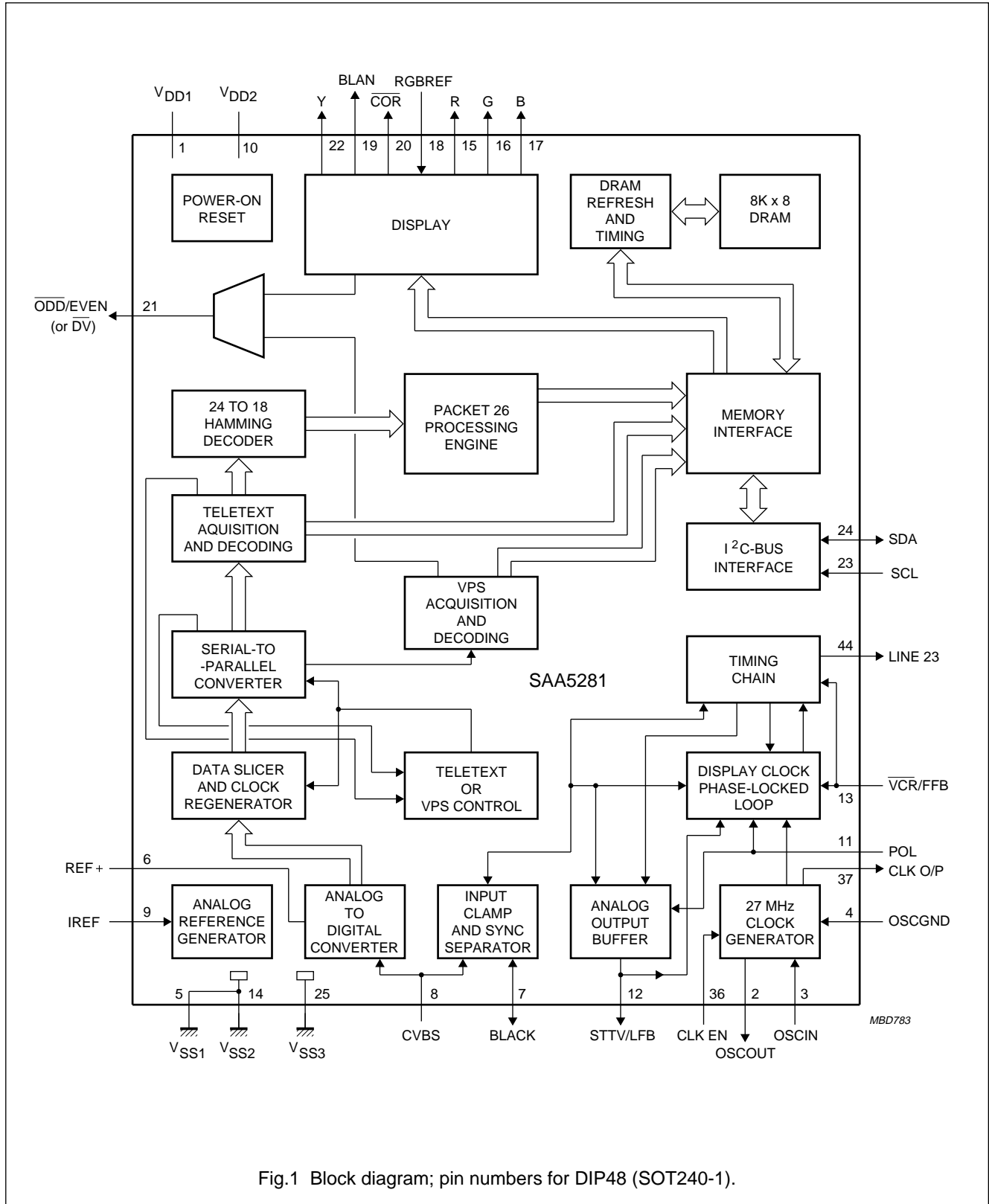

Fig.1 Block diagram; pin numbers for DIP48 (SOT240-1).

Integrated Video input processor and Teletext decoder (IVT1.8*)

SAA5281

PINNING

SYMBOL	PIN			DESCRIPTION
	SOT240-1	SOT247-1	SOT319-2	
V _{DD1}	1	52	11	+5 V supply 1
OSCO _{UT}	2	1	13	27 MHz crystal oscillator output
OSCI _N	3	2	14	27 MHz crystal oscillator input
OSCG _{ND}	4	3	15	0 V crystal oscillator ground
V _{SS1}	5	4 and 5	16	0 V ground
REF ₊	6	6	18	positive reference voltage for ADC; this pin should be connected to ground via a 100 nF capacitor
BLACK	7	8	19	video black level storage input/output; this pin should be connected to ground via a 100 nF capacitor
CVBS	8	9	20	composite video input; a positive-going 1 V (peak-to-peak) input is required, connected via a 100 nF capacitor
IREF	9	10	21	reference current input, connected to ground via a 27 kΩ resistor
V _{DD2}	10	11	22	+5 V supply 2
POL	11	12	23	STTV/LFB/FFB polarity selection input
STTV/LFB	12	13	24	sync to TV output line flyback input; function controlled by an internal register bit (scan sync mode)
VCR/FFB	13	14	27	PLL time constant switch/field input; function controlled by an internal register bit (scan sync mode)
V _{SS2}	14	15	28	0 V ground; connected to V _{SS1} for normal operation
R	15	16	30	dot rate character output of the RED colour information
G	16	17	32	dot rate character output of the GREEN colour information
B	17	18	33	dot rate character output of the BLUE colour information
RGBREF	18	19	34	input DC voltage to define the output high level on the RGB pins
BLAN	19	20	35	dot rate fast blanking output
COR	20	21	36	programmable output to provide contrast reduction of the TV picture for mixed text and picture displays or when viewing newflash/subtitle pages; open-drain output
ODD/EVEN (or \overline{DV})	21	22	37	in \overline{ODD} /EVEN mode a 25 Hz output synchronized with the CVBS input field sync pulses to produce a non-interlaced display by adjustment of the vertical deflection currents; in \overline{DV} mode a VPT data valid signal is used to indicate reception of error-free VPS or 8/30 format 2 data
Y	22	23	38	dot rate character output of teletext foreground colour information; open-drain output
SCL	23	24	39	serial clock input for I ² C-bus; it can still be driven HIGH during power-down of the device
SDA	24	25	40	serial data port for the I ² C-bus, open-drain output; it can still be driven HIGH during power-down of the device
V _{SS3}	25	26	44	0 V ground

Integrated Video input processor and Teletext decoder (IVT1.8*)

SAA5281

SYMBOL	PIN			DESCRIPTION
	SOT240-1	SOT247-1	SOT319-2	
i.c.	26 to 35, 38 to 43, 45 to 48	27 to 32, 35 to 38, 41 to 46, 48 to 51	1 to 3, 5 to 8, 45 to 53, 55, 61, 63 to 64	internally connected; normally open-circuit
CLK EN	36	39	56	clock enable input to enable the clock output (CLP O/P pin 37); internal pull-down normally disables clock
CLK O/P	37	40	59	13.5 MHz clock output to drive an external microcontroller
LINE 23	44	47	4	output for indication of Line 23 for use with external circuitry
n.c.	–	7, 33, 34	9, 10, 12, 17, 25, 26, 29, 31, 41 to 43, 54, 57, 58, 60, 62	not connected; normally open-circuit

Integrated Video input processor and
Teletext decoder (IVT1.8*)

SAA5281

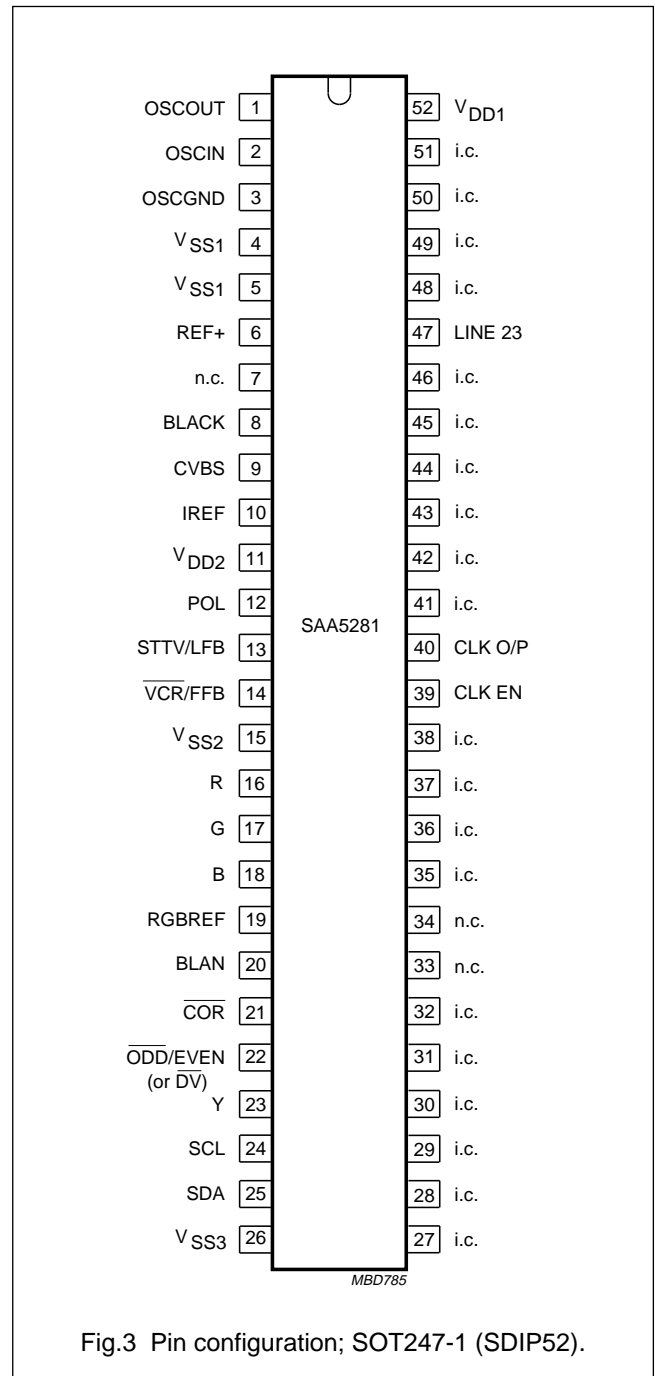
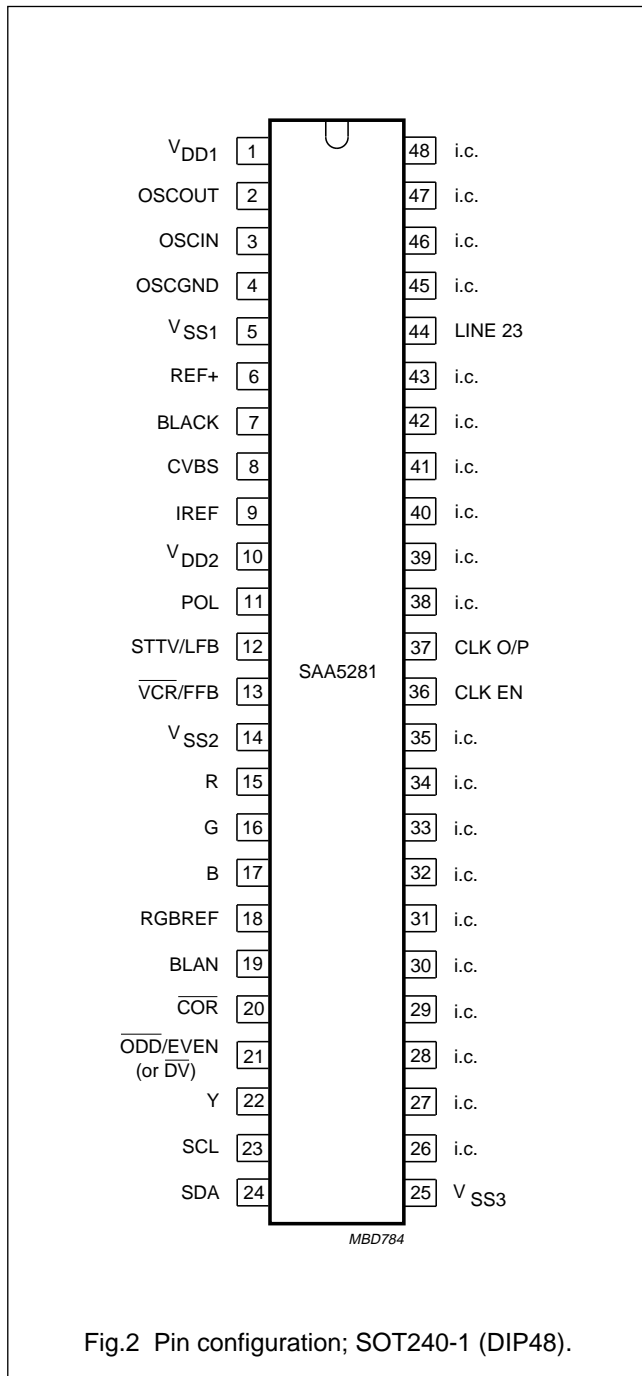

Integrated Video input processor and
Teletext decoder (IVT1.8*)

SAA5281

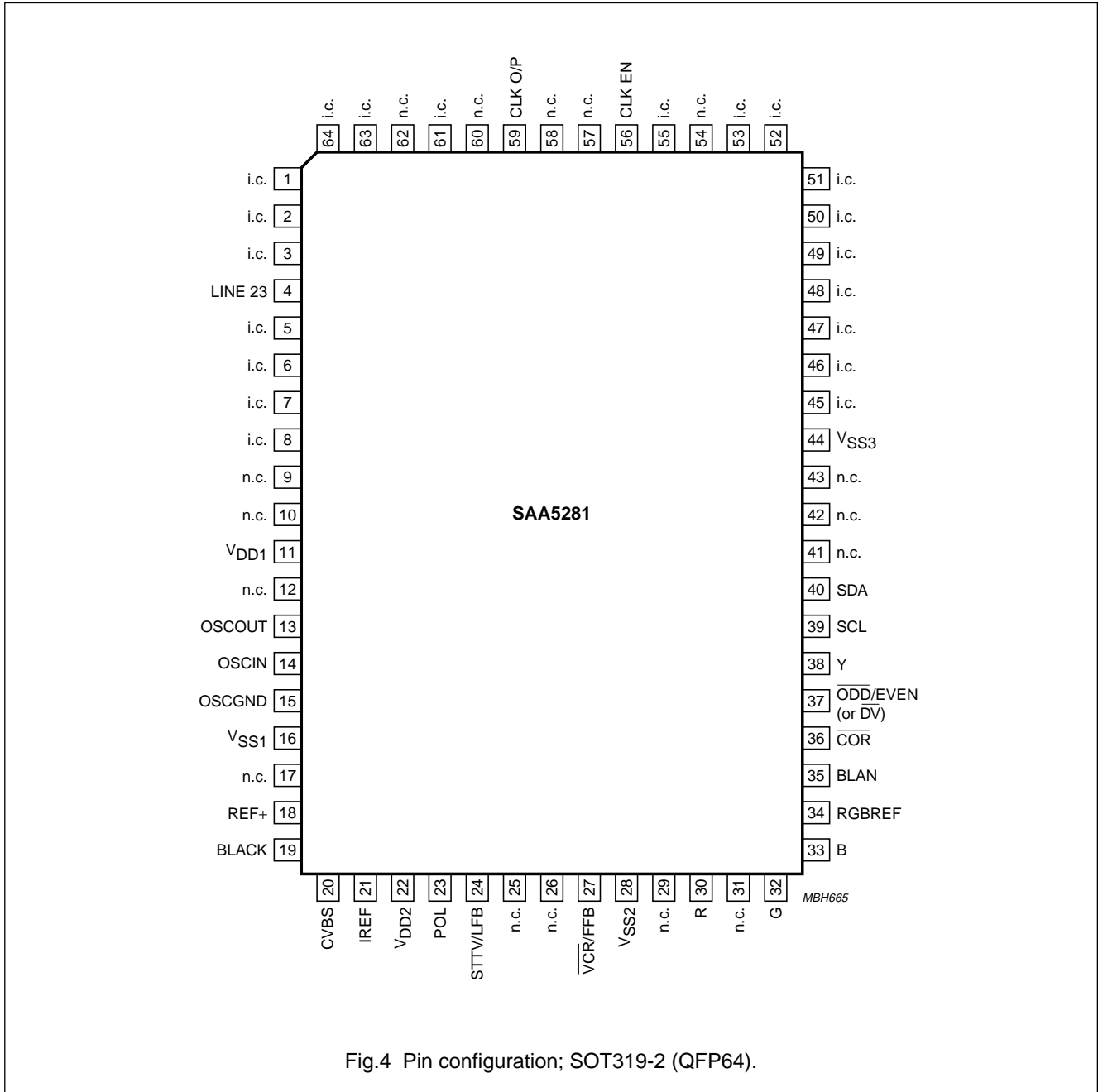

Fig.4 Pin configuration; SOT319-2 (QFP64).

Integrated Video input processor and Teletext decoder (IVT1.8*)

SAA5281

QUALITY AND RELIABILITY

This device will meet Philips Semiconductors General Quality Specification for Business group "Consumer Integrated Circuits SNW-FQ-611-Part E". The principal requirements are shown in Tables 1 to 4.

Group A

Table 1 Acceptance tests per lot

TEST	REQUIREMENTS ⁽¹⁾
Mechanical	cumulative target: <100 ppm
Electrical	cumulative target: <100 ppm

Group B

Table 2 Processability tests (by package family)

TEST	REQUIREMENTS ⁽¹⁾
Solderability	<7% LTPD
Mechanical	<15% LTPD
Solder heat resistance	<15% LTPD

Group C

Table 3 Reliability tests (by process family)

TEST	CONDITIONS	REQUIREMENTS ⁽¹⁾
Operational life	168 hours at $T_j = 150\text{ °C}$	<1500 FPM; equivalent to <100 FITS at $T_j = 70\text{ °C}$
Humidity life	temperature, humidity, bias 1000 hours, 85 °C, 85% RH (or equivalent test)	<2000 FPM
Temperature cycling performance	$T_{stg(min)}$ to $T_{stg(max)}$	<2000 FPM

Table 4 Reliability tests (by device type)

TEST	CONDITIONS	REQUIREMENTS ⁽¹⁾
ESD and latch-up	ESD Human body model 2000 V, 100 pF, 1.5 k Ω	<15% LTPD
	ESD Machine model 200 V, 200 pF, 0 Ω	<15% LTPD
	latch-up 100 mA, $1.5 \times V_{DD}$ (absolute maximum)	<15% LTPD

Notes to Tables 1 to 4

- ppm = fraction of defective devices, in parts per million.
LTPD = Lot Tolerance Percent Defective.
FPM = fraction of devices failing at test condition, in Failures Per Million.
FITS = Failures In Time Standard.

Integrated Video input processor and Teletext decoder (IVT1.8*)

SAA5281

LIMITING VALUES

In accordance with Absolute Maximum Rating System (IEC 134).

SYMBOL	PARAMETER	MIN.	MAX.	UNIT
V_{DD}	supply voltage (all supplies)	-0.3	+6.5	V
V_I	input voltage (any input)	-0.3	$V_{DD} + 0.5$	V
V_O	output voltage (any output)	-0.3	$V_{DD} + 0.5$	V
I_O	output current (each output)	-	± 10	mA
I_{IOK}	DC input or output diode current	-	± 20	mA
T_{amb}	operating ambient temperature	-20	+70	°C

CHARACTERISTICS

 $V_{DD} = 5\text{ V} \pm 10\%$; $T_{amb} = -20$ to $+70\text{ °C}$; pin numbers refer DIP48 package; unless otherwise specified.

SYMBOL	PARAMETER	CONDITIONS	MIN.	TYP.	MAX.	UNIT
Supplies						
V_{DD}	supply voltage		4.5	5.0	5.5	V
I_{DDtot}	total supply current		-	75	150	mA
Inputs						
CVBS						
V_{sync}	sync voltage amplitude		0.1	0.3	0.6	V
$V_{burst(p-p)}$	colour burst amplitude (peak-to-peak value)		0.0	0.3	4.0	V
$t_{d(sync)}$	delay from CVBS to TCS output from STTV buffer (nominal video, average of leading/trailing edge)		-150	0	+150	ns
$\Delta t_{d(sync)}$	change in sync delay between all black and all white video input at nominal levels		0	-	25	ns
$V_{vid(p-p)}$	video input voltage amplitude (peak-to-peak value)		0.7	1.0	1.4	V
$V_{dat(text)}$	teletext data voltage amplitude		0.29	0.46	0.71	V
$\Delta f/f$	display PLL capture range		± 7	-	-	%
Z_{source}	source impedance		-	-	250	Ω
V_I	input switching voltage level of sync separator		1.7	2.0	2.3	V
Z_I	input impedance		2.5	5.0	-	k Ω
C_I	input capacitance		-	-	10	pF
IREF						
R_{gnd}	resistor to ground		-	27	-	k Ω
V_i	input voltage		-	$0.5V_{DD}$	-	V

Integrated Video input processor and Teletext decoder (IVT1.8*)

SAA5281

SYMBOL	PARAMETER	CONDITIONS	MIN.	TYP.	MAX.	UNIT
POL						
V _{IL}	LOW level input voltage		-0.3	-	+0.8	V
V _{IH}	HIGH level input voltage		2.0	-	V _{DD} + 0.5	V
I _{LI}	input leakage current	V _I = 0 to V _{DD}	-10	-	+10	μA
C _I	input capacitance		-	-	10	pF
LFB						
V _{IL}	LOW level input voltage		-0.3	-	tbF	V
V _{IH}	HIGH level input voltage		tbF	-	V _{DD} + 0.5	V
I _{LI}	input leakage current	V _I = 0 to V _{DD}	-10	-	+10	μA
I _{Imax}	maximum input current	note 1	-1	-	+1	mA
t _{dLFB}	delay between LFB front edge and input video line sync		-	250	-	ns
VCR/FFB						
V _{IL}	LOW level input voltage		-0.3	-	+0.8	V
V _{IH}	HIGH level input voltage		2.0	-	V _{DD} + 0.5	V
I _{LI}	input leakage current	V _I = 0 to V _{DD}	-10	-	+10	μA
I _{Imax}	maximum input current	note 1	-1	-	+1	mA
RGBREF						
V _{IL}	LOW level input voltage		-0.3	-	V _{DD}	V
I _{LI}	input leakage current	V _I = 0 to V _{DD}	-10	-	+10	μA
SCL						
V _{IL}	LOW level input voltage		-0.3	-	+1.5	V
V _{IH}	HIGH level input voltage		3.0	-	V _{DD} + 0.5	V
I _{LI}	input leakage current	V _I = 0 to V _{DD}	-10	-	+10	μA
C _I	input capacitance		-	-	10	pF
f _{clk}	clock frequency		0	-	100	kHz
t _r	input rise time	between 10% and 90%	-	-	2	μs
t _f	input fall time	between 90% and 10%	-	-	2	μs
Inputs/outputs						
CRYSTAL OSCILLATOR (OSCIN; OSCOUT)						
V _{osc(p-p)}	oscillator voltage amplitude (peak-to-peak value)		-	1.0	-	V
G _v	small signal voltage gain		-	1.0	-	
G _m	mutual conductance		5.0	-	-	mS
C _I	input capacitance		-	-	10	pF
C _{fb}	feedback capacitance		-	1	-	pF

Integrated Video input processor and Teletext decoder (IVT1.8*)

SAA5281

SYMBOL	PARAMETER	CONDITIONS	MIN.	TYP.	MAX.	UNIT
BLACK						
C_{black}	storage capacitor to ground		–	100	–	nF
V_{black}	black level voltage for nominal sync amplitude		1.8	2.15	2.5	V
I_{LI}	input leakage current	$V_I = 0$ to V_{DD}	–10	–	+10	μ A
SDA (OPEN-DRAIN INPUT/OUTPUT)						
V_{IL}	LOW level input voltage		–0.3	–	+1.5	V
V_{IH}	HIGH level input voltage		3.0	–	$V_{DD} + 0.5$	V
V_{OL}	LOW level output voltage	$I_{OL} = 3$ mA	0	–	0.5	V
I_{LI}	input leakage current	$V_I = 0$ to V_{DD}	–10	–	+10	μ A
C_I	input capacitance		–	–	10	pF
C_L	load capacitance		–	–	400	pF
t_r	input rise time	between 10% and 90%	–	–	2	μ s
t_f	input fall time	between 90% and 10%	–	–	2	μ s
t_f	output fall time	between 3 V and 1 V	–	–	200	ns
Outputs						
STTV						
G_{sttv}	gain of STTV relative to video input		0.9	1.0	1.1	
V_{tcs}	TCS voltage amplitude		0.2	0.3	0.45	V
ΔV_{tcs}	DC shift between TCS output and nominal video output		–	–	0.15	V
I_O	output drive current		–	–	3.0	mA
C_L	load capacitance		–	–	100	pF
R, G AND B						
V_{OL}	LOW level output voltage	$I_{OL} = 2$ mA	0	–	0.2	V
V_{OH}	HIGH level output voltage	$I_{OH} = -1.6$ mA; $V_{RGBREF} < V_{DD} - 2$ V; note 2	$V_{RGBREF} - 0.25$	V_{RGBREF}	$V_{RGBREF} + 0.5$	V
$ Z_o $	output impedance		–	–	200	Ω
C_L	load capacitance		–	–	50	pF
t_r	output rise time	between 10% and 90%	–	–	20	ns
t_f	output fall time	between 90% and 10%	–	–	20	ns
BLAN						
V_{OL}	LOW level output voltage	$I_{OL} = 1.6$ mA	0	–	0.4	V
V_{OH}	HIGH level output voltage	$I_{OH} = -0.2$ mA	1.1	–	–	V
		$I_{OH} = 0$ mA	–	–	2.8	V
C_L	load capacitance		–	–	50	pF
t_r	output rise time	between 10% and 90%	–	–	20	ns
t_f	output fall time	between 90% and 10%	–	–	20	ns

Integrated Video input processor and Teletext decoder (IVT1.8*)

SAA5281

SYMBOL	PARAMETER	CONDITIONS	MIN.	TYP.	MAX.	UNIT
$\overline{\text{ODD/EVEN}}$ OR $\overline{\text{DV}}$						
V_{OL}	LOW level output voltage	$I_{OL} = 1.6 \text{ mA}$	0	–	0.4	V
V_{OH}	HIGH level output voltage	$I_{OH} = -1.6 \text{ mA}$	$V_{DD} - 0.4$	–	V_{DD}	V
C_L	load capacitance		–	–	120	pF
t_r	output rise time	between 0.6 V and 2.2 V	–	–	50	ns
t_f	output fall time	between 0.6 V and 2.2 V	–	–	50	ns
$\overline{\text{COR}}$ AND Y (OPEN-DRAIN OUTPUTS)						
V_{OH}	HIGH level pull-up output voltage		–	–	V_{DD}	V
V_{OL}	LOW level output voltage	$I_{OL} = 2 \text{ mA}$	0	–	0.4	V
		$I_{OL} = 5 \text{ mA}$	0	–	1.0	V
C_L	load capacitance		–	–	25	pF
t_f	output fall time	load resistor of 1.2 k Ω to V_{DD} ; measured between $V_{DD} - 0.5 \text{ V}$ and 1.5 V	–	–	50	ns
I_{LO}	output leakage current	$V_I = 0 \text{ to } V_{DD}$	-10	–	+10	μA
t_{skew}	skew delay between display outputs R, G, B, COR, Y and BLAN		–	–	20	ns
I²C-bus timing (see Fig.5)						
t_{LOW}	SCL clock LOW time		4.0	–	–	μs
t_{HIGH}	SCL clock HIGH time		4.0	–	–	μs
$t_{SU;DAT}$	data set-up time		250	–	–	ns
$t_{HD;DAT}$	data hold time		170	–	–	ns
$t_{SU;STO}$	set-up time from clock HIGH to STOP		4.0	–	–	μs
t_{BUF}	START set-up time following a STOP		4.0	–	–	μs
$t_{HD;STA}$	START hold time		4.0	–	–	μs
$t_{SU;STA}$	START set-up time following a clock LOW-to-HIGH transition		4.0	–	–	μs

Notes

1. This current is the maximum allowed into the inputs when line and field flyback signals are connected to these inputs. Series current limiting resistors must be used to limit the input currents to $\pm 1 \text{ mA}$.
2. Voltage level V_{OH} for R, G and B outputs is taken to be the mean value during the output HIGH time. If higher R, G and B voltage V_{OH} levels are required RGBREF voltage level may be raised and a pull-up resistor used at each of these pins provided current specification (I_{OL}) is not exceeded.

Integrated Video input processor and Teletext decoder (IVT1.8*)

SAA5281

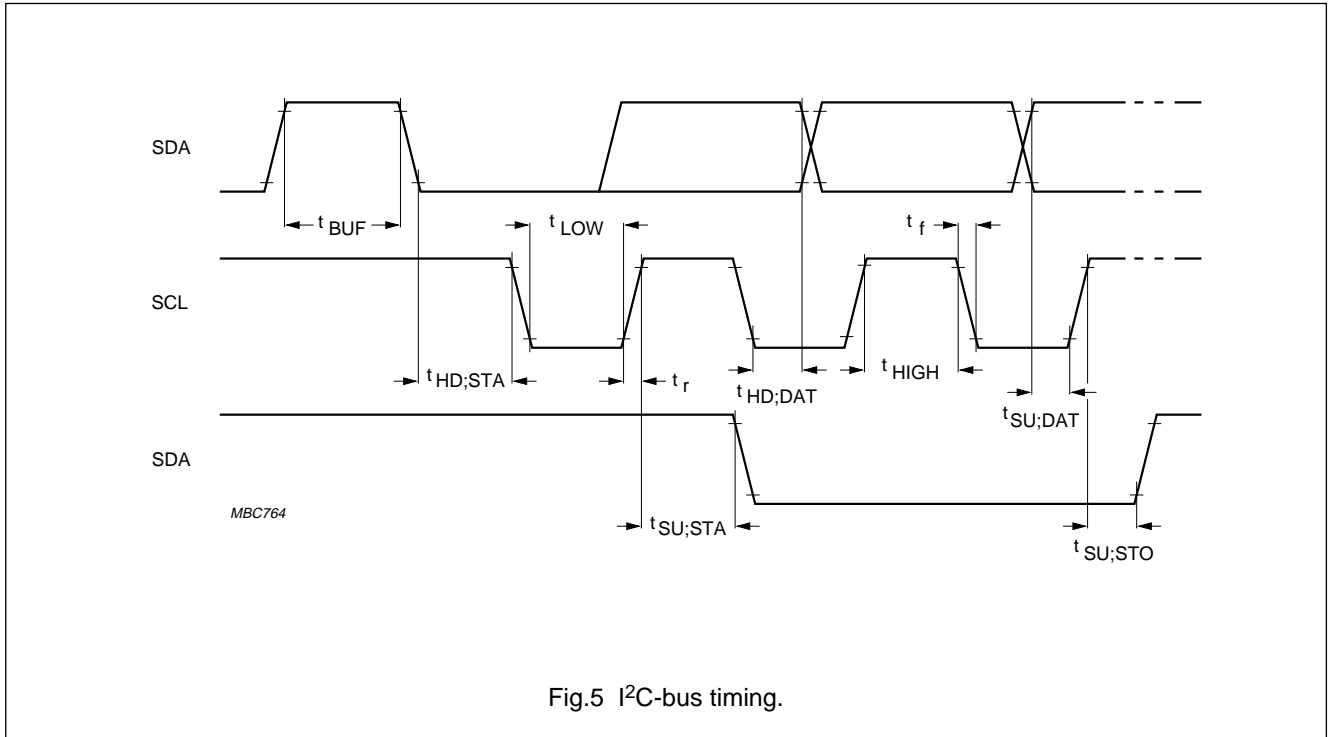
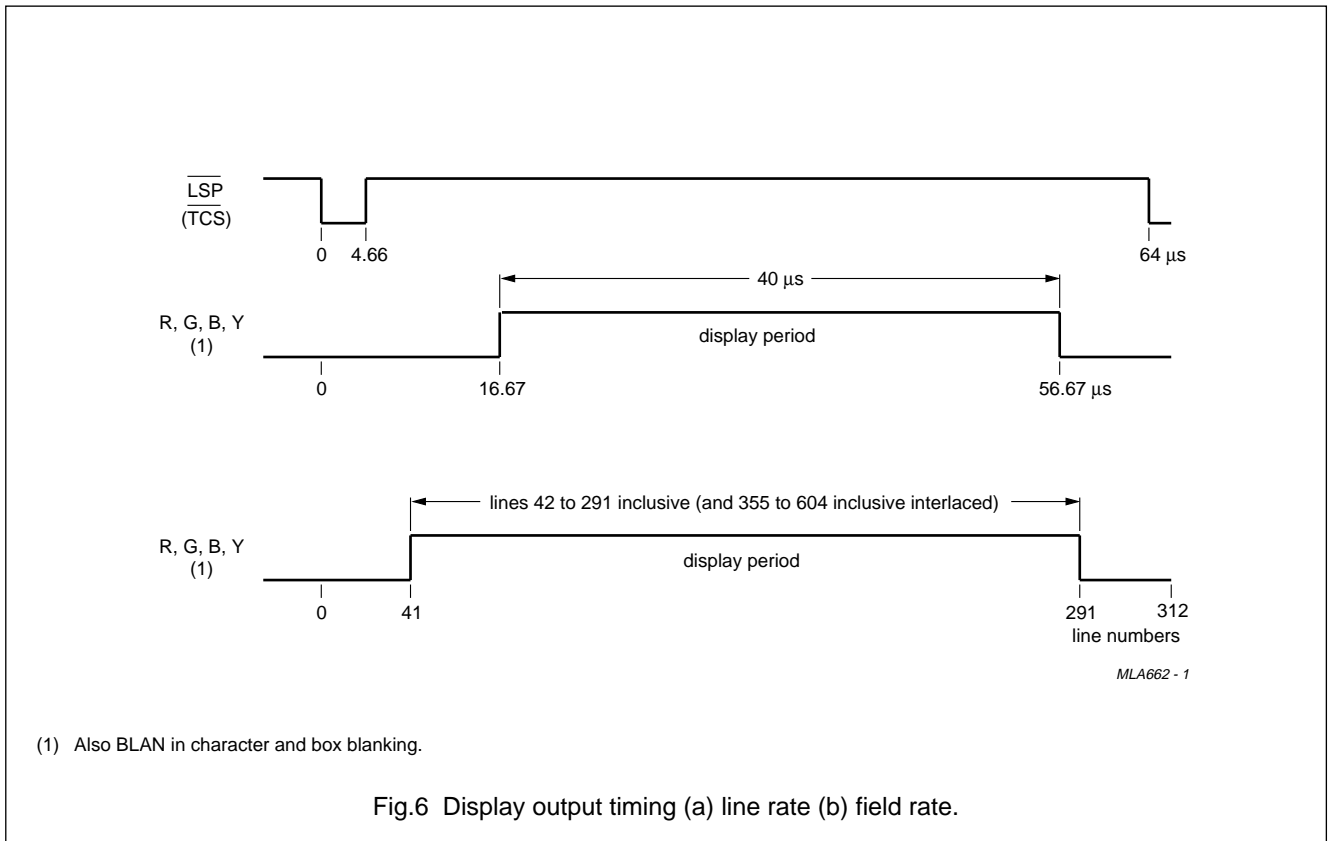

Fig.5 I²C-bus timing.

TIMING CHAIN



(1) Also BLAN in character and box blanking.

Fig.6 Display output timing (a) line rate (b) field rate.

Integrated Video input processor and Teletext decoder (IVT1.8*)

SAA5281

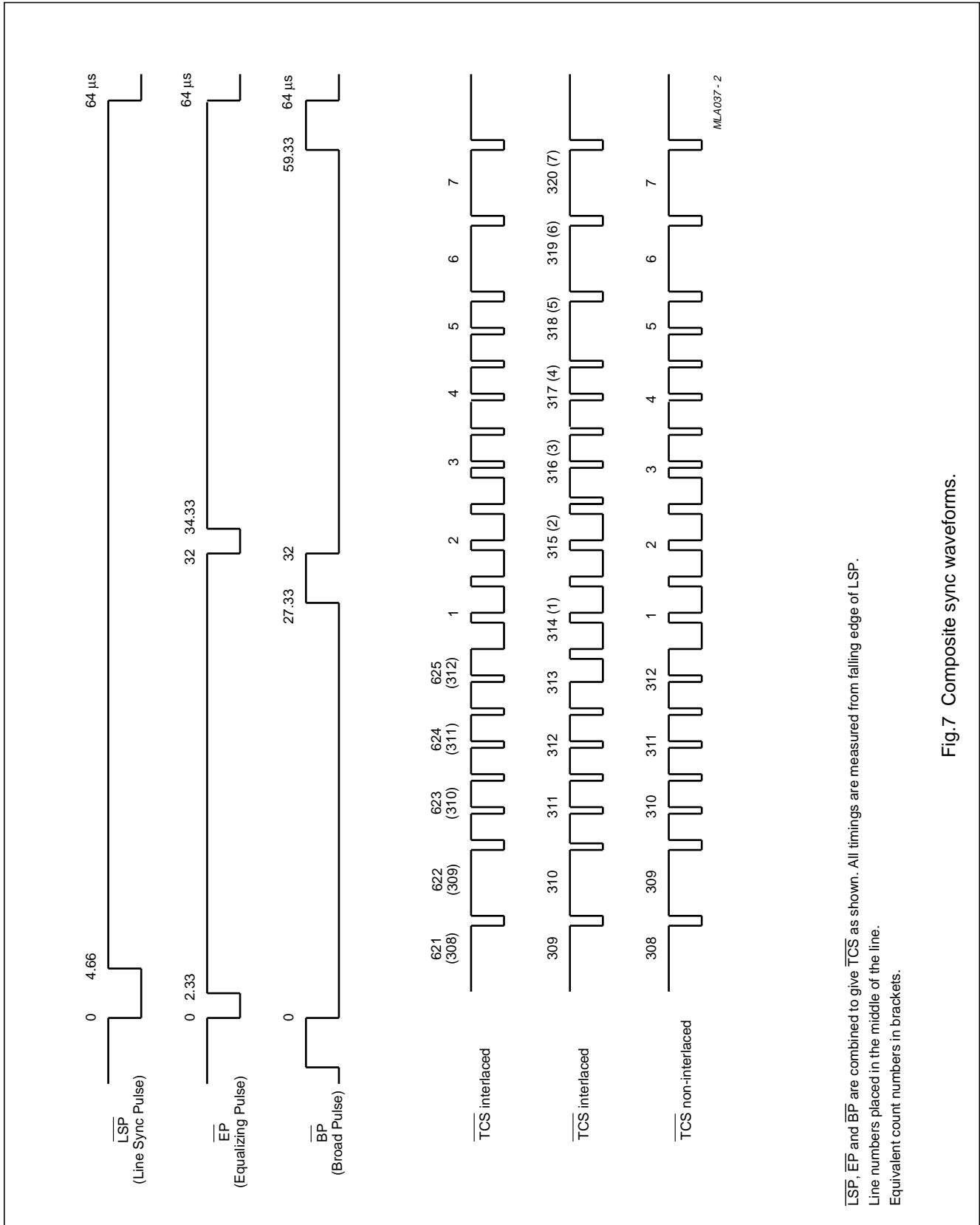

LSP, EP and BP are combined to give TCS as shown. All timings are measured from falling edge of LSP. Line numbers placed in the middle of the line. Equivalent count numbers in brackets.

Fig.7 Composite sync waveforms.

Integrated Video input processor and
Teletext decoder (IVT1.8*)

SAA5281

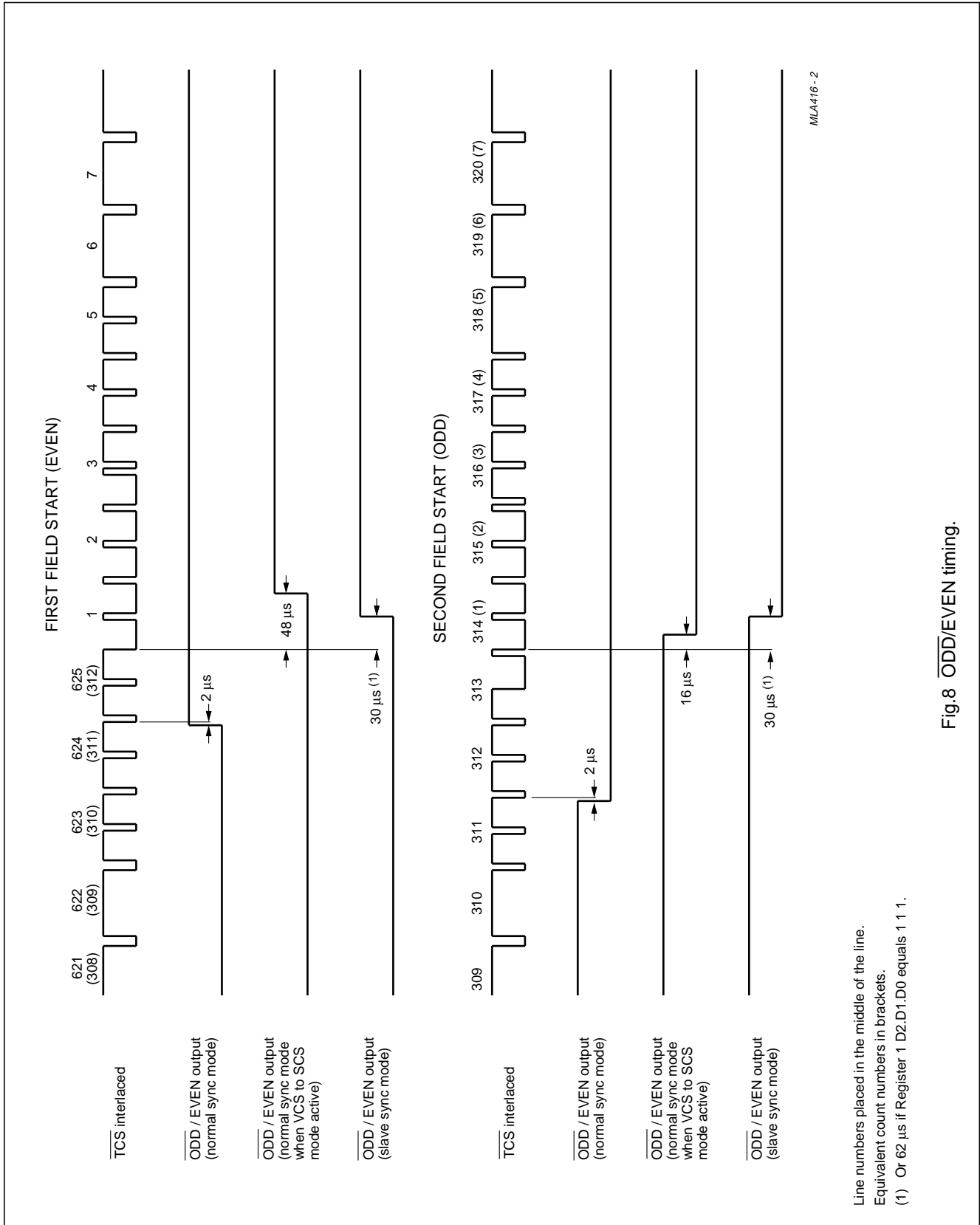

Fig.8 ODD/EVEN timing.

Line numbers placed in the middle of the line.
Equivalent count numbers in brackets.
(1) Or 62 μs if Register 1 D2.D1.D0 equals 1 1 1.

Integrated Video input processor and Teletext decoder (IVT1.8*)

SAA5281

ON-CHIP MEMORY

Page memory organization

The organization of the page memory is illustrated by Fig.9. The IVT1.8* provides an additional row as compared with first generation decoders; this brings the display format up to 40 characters by 25 rows. Rows 0 to 23 form the teletext page; row 24 is the extra row available for software generated status messages and FLOF/FASTEXT prompt information.

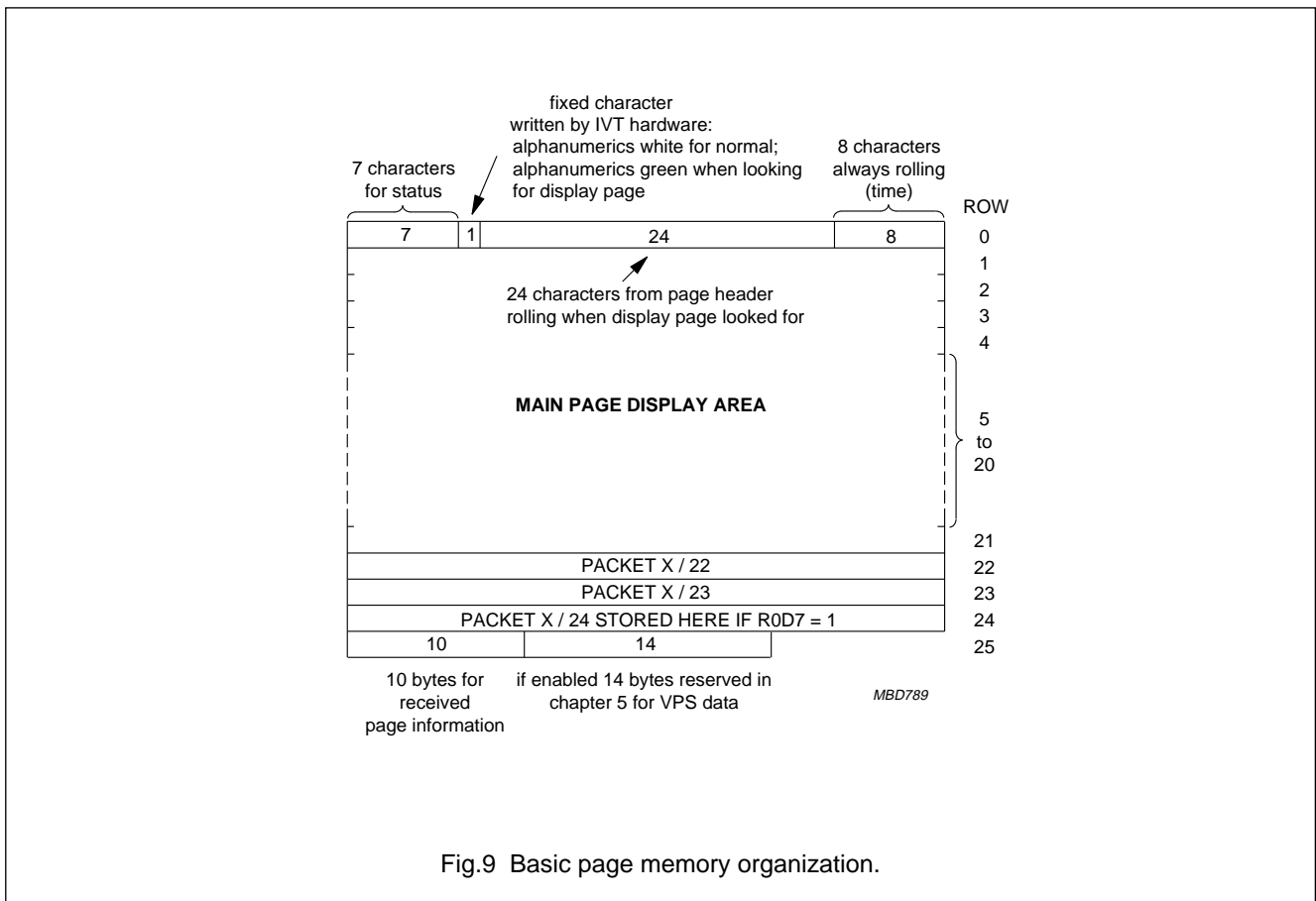

Fig.9 Basic page memory organization.

REMARK TO Fig.9

Row 0

Row 0 is for the page header. The first seven characters (0 to 6) are free for status messages. Character 8 is an alphanumeric white or green control character, written automatically by IVT1.8* to give a green rolling header when a page is being looked for. The last eight characters are for rolling time.

Row 25

The first 10 bytes of row 25 contain control data relating to the received page as shown in Table 5. The remaining 14 bytes are free for use by the microcomputer.

**Integrated Video input processor and
Teletext decoder (IVT1.8*)**

SAA5281

Table 5 Row 25 received control data format

ROW 25										
D0	PU0	PT0	MU0	MT0	HU0	HT0	C7	C11	MAG0	0
D1	PU1	PT1	MU1	MT1	HU1	HT1	C8	C12	MAG1	0
D2	PU2	PT2	MU2	MT2	HU2	C5	C9	C13	MAG2	0
D3	PU3	PT3	MU3	C4	HU3	C6	C10	C14	0	0
D4	HAM.ER	HAM.ER	HAM.ER	HAM.ER	HAM.ER	HAM.ER	HAM.ER	HAM.ER	FOUND	0
D5	0	0	0	0	0	0	0	0	0	PBLF
D6	0	0	0	0	0	0	0	0	0	0
D7	0	0	0	0	0	0	0	0	0	0
Column	0	1	2	3	4	5	6	7	8	9

Table 6 Page number and sub-code for Table 5

BIT NAME	DESCRIPTION
Page number	
MAG	magazine
PU	page units
PT	page tens
PBLF	page being looked for
FOUND	LOW for page has been found
HAM.ER	Hamming error in corresponding byte
Page sub-code	
MU	minutes units
MT	minutes tens
HU	hours units
HT	hours tens
C4 to C14	transmitted control bits

Integrated Video input processor and Teletext decoder (IVT1.8*)

SAA5281

Extension packet memory organization

When in normal extension packet enabled mode the rows of information are organized as illustrated in Fig.10.

Row 23 of the extension page, as shown in Fig.10, contains packet 8/30. Packet 8/30 is mapped into the IVT1.8* memory as follows:

- 8 / 30 / 0 and 8 / 30 / 1 to Chapter 4 Row 23
- 8 / 30 / 2 and 8 / 30 / 3 to Chapter 5 Row 23
- 8 / 30 / 4 to 8 / 30 / 15 to Chapter 6 Row 23.

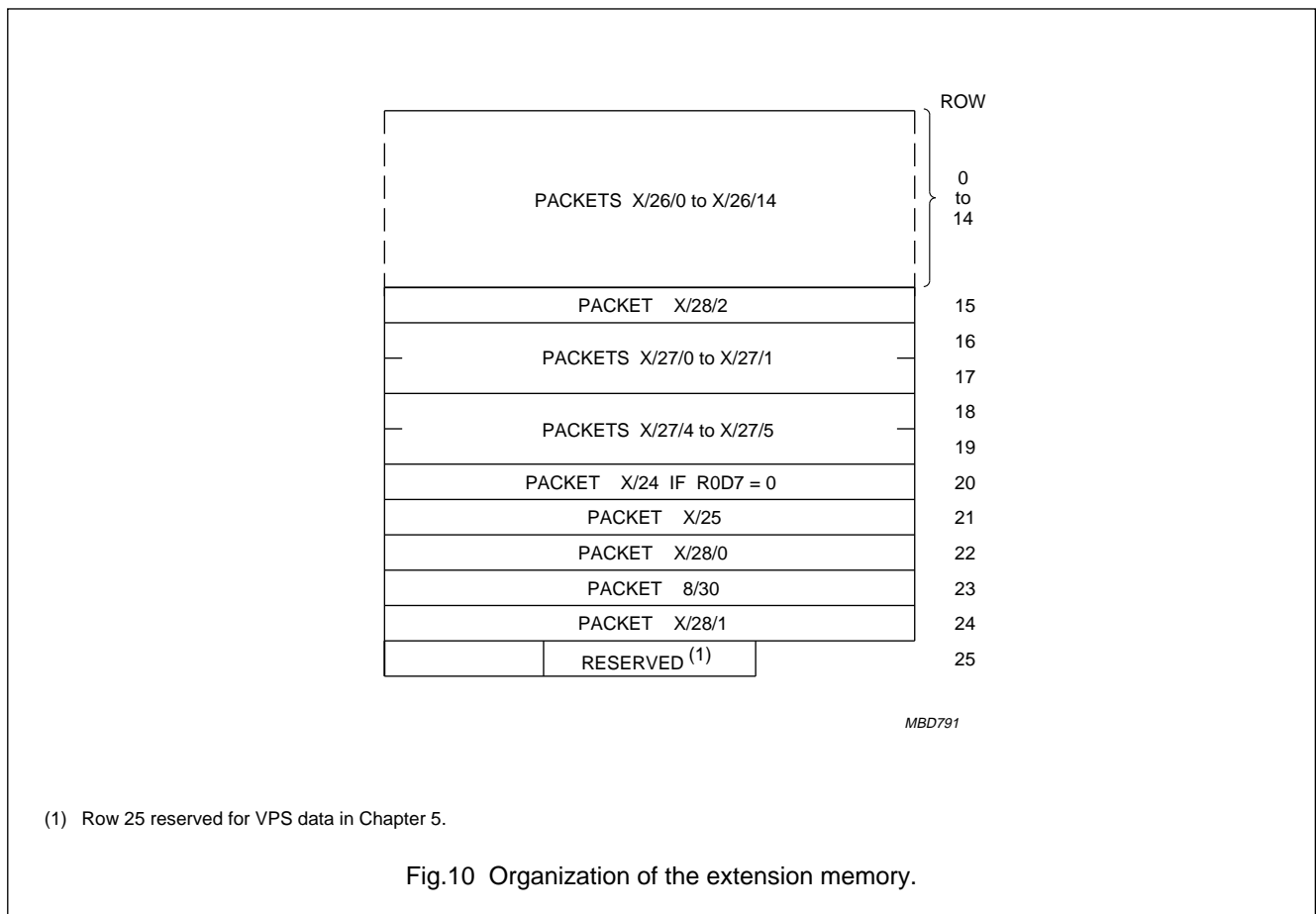

Integrated Video input processor and Teletext decoder (IVT1.8*)

SAA5281

ENHANCED MODE

In enhanced mode, the number of extension packets captured is reduced to the minimum required for FASTEXT operation. The first seven chapters can then be used for storage, using the system of pointers. The arrangement of extension packets is shown in Fig.11.

When in enhanced mode and extension packets are disabled, normal 8-page mode is in operation, but the X/26 engine is enabled (unlike normal 8-page mode).

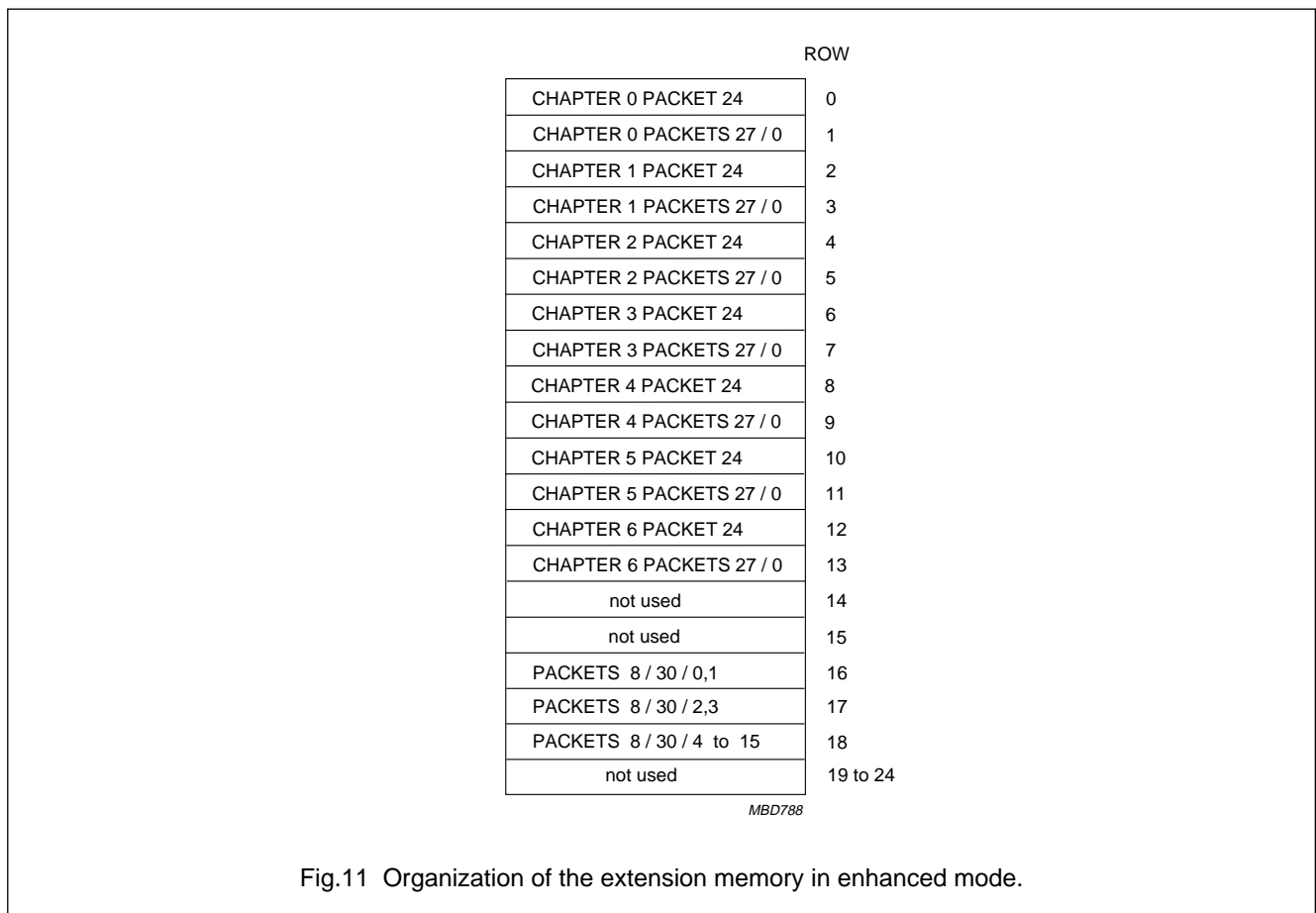

Integrated Video input processor and Teletext decoder (IVT1.8*)

SAA5281

VPT data memory organization

To simplify the software for dual-standard VPT decoders, the VPS data from line 16 is stored in row 25 of Chapter 5 of the page memory, and is aligned to match the packet 8/30 format 2 data as far as possible. The 8/30 format 2 packet is Hamming coded and by setting the appropriate register control bit the data is stored after hardware Hamming correction. There are 4 data bits stored in each column address of memory with an additional Hamming error bit. The data equivalent to the VPS signal is found in columns 12 to 19.

Although the VPS data is not Hamming protected, it is stored with 4 data bits per column address in the same way with an additional biphase error bit. The extra space in Row 25 is allocated to two more Line 16 words.

They are Word 15 (reserved) and Word 4 (Program Source Identification, ASCII sequential) which may be useful for future applications. Details of the memory organization are shown in Fig.12.

The stored data can be read from memory via the I²C-bus in the normal way. Multiple reception/majority error correction of the VPS data is the responsibility of the control software, the device simply stores the data as transmitted after biphase decoding.

As both VPS and 8/30/2 signals are stored in separate memory locations, it is possible to deal with future situations where both System A and System B transmissions may be present on the same TV channel, the defaults and level of service chosen by the control software.

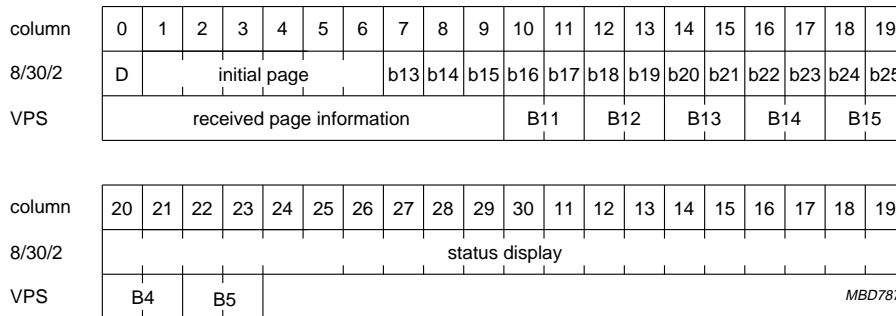

Fig.12 Detailed memory organization.

Integrated Video input processor and
Teletext decoder (IVT1.8*)

SAA5281

Register maps

IVT1.8* mode registers R0 to R13 are shown in Table 7. R0 to R10, R12 and R13 are WRITE only; R11 is READ/WRITE, R11B is read only. Register map (R3), for page requests, is shown in detail in Table 11.

Table 7 Register map (notes 1 to 4)

REGISTER		D7	D6	D5	D4	D3	D2	D1	D0
NAME	No.								
Advanced control	0	X/24 POS	FREE RUN PLL	AUTO ODD/EVEN	DISABLE HDR ROLL	CBB SLAVE SYNC	DISABLE ODD/EVEN	VCR MODE	R11/R11B SELECT
Mode	1	VCS TO SCS	7 + P/ 8-BIT	ACQ ON/OFF	EXT PKT ENABLE	DEW/ FULL FIELD	TCS ON	T1	T0
Page request address	2	HAM CHECK 27, 8/30	BANK SELECT A2	ACQ CCT A1	ACQ CCT A0	0	SC2	SC1	SC0
Page request data	3	-	-	-	PRD4	PRD3	PRD2	PRD1	PRD0
Display chapter	4	-	-	-	-	FREEZE HEADER ONLY	A2	A1	A0
Display control (normal)	5	BKGND OUT	BKGND IN	COR OUT	COR IN	TEXT OUT	TEXT IN	PON OUT	PON IN
Display control (newsflash /subtitle)	6	BKGND OUT	BKGND IN	COR OUT	COR IN	TEXT OUT	TEXT IN	PON OUT	PON IN
Display mode	7	STATUS BTM/TOP	CURSOR ON	CONCEAL/ REVEAL ON	TOP/BTM HALF	SINGLE/ DOUBLE HEIGHT	BOX ON 24	BOX ON 1 to 23	BOX ON 0
Active chapter	8	-	-	-	VPS ENABLE	CLEAR MEM	A2	A1	A0
Cursor row	9	-	-	-	R4	R3	R2	R1	R0
Cursor column	10	-	-	C5	C4	C3	C2	C1	C0
Cursor data	11	D7	D6	D5	D4	D3	D2	D1	D0
Device status	11B	625/525 SYNC	ROM VER R4	ROM VER R3	ROM VER R2	ROM VER R1	ROM VER R0	TEXT SIGNAL QUALITY	VCS SIGNAL QUALITY
Advanced control 2A	12	H3	H2	H1	H0	S3	S2	S1	S0
Advanced control 2B	13	ENHANC MODE	CURSOR FREEZE/ DEVICE IDENT	MESHING ENABLE	VPS ENABLE	POINTS ENABLE	HAM CHECK 24 : 18	DISABLE PKT X/26	AUTO DISPLAY PKT X/24

Integrated Video input processor and Teletext decoder (IVT1.8*)

SAA5281

Notes to Table 7

1. The dash (–) indicates these bits are inactive and must be written to logic 0 for future compatibility.
2. Certain registers are auto-incremented following an I²C-bus transmission byte. These are Register R0 to R3, R4 to R7 and R8 to R12 or R13.
3. All bits in Registers R0 to R13 are cleared to logic 0 on power-up except bits D0 and D1 of Registers R1, R5 and R6 which are set to logic 1.
4. All memory is cleared to space (00100000) on power-up, except Row 0 Column 7 Chapter 0, which is alpha white (00000111) as the acquisition circuit is enabled but all pages are on hold.

Table 8 Register description

REGISTER BIT D0 TO D7	FUNCTION
R0 AVANCED CONTROL - auto-increments to Register 1	
R11/R11B SELECT	Selects reading of R11 if LOW or R11B if HIGH.
VCR MODE	If logic 1 selects short time constant mode of PLL.
DISABLE $\overline{\text{ODD}}$ /EVEN	Forces $\overline{\text{ODD}}$ /EVEN output LOW when logic 1 (see Table 9).
CBB SLAVE SYNC	When set will modify internal slave sync timing to allow connection to sandcastle of Philips one-chip TV IC (TDA8362).
DISABLE HDR ROLL	Stops the display update of rolling time and green rolling header during page requests when logic 1. Time updates on page reception only.
AUTO $\overline{\text{ODD}}$ /EVEN	If logic 1 then $\overline{\text{ODD}}$ /EVEN output only active when no TV picture displayed (see Table 9).
FREE RUN PLL	Will force the display PLL to free run at 6 MHz when logic 1.
X/24 POS	Automatic display of FASTEXT prompt row when logic 1. Will also cause Row 24 data transmitted by packet 26 to be written to display, rather than extension memory.
R1 MODE - auto-increments to Register 2	
T0, T1	Interlace/non-interlace 312/313 line control (see Table 10).
TCS ON	Text composite sync or direct sync select (see Table 10 for FFB mode selection).
$\overline{\text{DEW}}$ /FULL FIELD	Field-flyback or full-channel mode.
EXT PKT ENABLE	Enables reception and storage of extension packets when logic 1.
ACQ $\overline{\text{ON}}$ /OFF	Acquisition circuits turned off when logic 1.
$\overline{7} + \overline{P}$ /8-BIT	7 bits with parity checking or 8-bit mode.
VCS TO SCS	Connects VCS from video sync separator to display field sync detector to enable stable display of 60 Hz status messages when logic 1.
R2 PAGE REQUEST ADDRESS - auto-increments to Register 3	
SC0 to SC2	Start column for page request data (see Table 11).
0	Must be logic 0 for normal operation.
ACQ CCT A0, A1	Selects one of four acquisition circuits.
BANK SELECT A2	Selects bank of four pages being addressed for acquisition.
HAM CHECK 27, 8/30	8/4 Hamming check packet 27 and 8/30 data.
R3 PAGE REQUEST DATA - does not auto-increment	
PRD0 to PRD4	See Table 11.

Integrated Video input processor and Teletext decoder (IVT1.8*)

SAA5281

REGISTER BIT D0 TO D7	FUNCTION
R4 DISPLAY CHAPTER - auto-increments to Register 5	
A0 to A2	Selects one of 8 display chapters.
FREEZE HEADER ONLY	Freezes the rolling header, but (unlike R0D4) allows the time to roll.
R5 NORMAL DISPLAY CONTROL - auto-increments to Register 6	
R6 NEWSFLASH/SUBTITLE DISPLAY CONTROL - auto-increments to Register 7; note 1	
PON	Picture on.
TEXT	Text on.
COR	Contrast reduction on.
BKGND	Background colour on.
R7 DISPLAY MODE - does not auto-increment	
BOX ON 0	Boxing function allowed on Row 0.
BOX ON 1 to 23	Boxing function allowed on Rows 1 to 23.
BOX ON 24	Boxing function allowed on Row 24.
SINGLE/DOUBLE HEIGHT	To display double height text.
TOP/BTM HALF	To select bottom half of page when DOUBLE HEIGHT is logic 1.
CONCEAL/REVEAL ON	To reveal concealed text.
CURSOR ON	To display cursor.
STATUS BTM/TOP	Row 25 displayed above or below the main text.
R8 ACTIVE CHAPTER - auto-increments to Register 9	
A0 to A2	Active chapter for data written to or read from memory via the I ² C-bus.
CLEAR MEM	When set to logic 1, clears the display memory. This bit is automatically reset.
VPS ENABLE	VPS acquisition enabled when logic 1.
R9 CURSOR ROW - auto-increments to Register 10	
R0 to R4	Active row for data written to or read from memory via the I ² C-bus.
R10 CURSOR COLUMN - auto-increments to Register 11 or 11B	
C0 to C5	Active column for data written to or read from memory via the I ² C-bus.
R11 CURSOR DATA - does not auto-increment	
D0 to D7	Data read from/written to memory via I ² C-bus, at location pointed to by R9 and R10. This location automatically increments each time R11 is accessed.
R11B DEVICE STATUS - does not auto-increment	
VCS SIGNAL QUALITY	Indicates that the video signal quality is good and PLL is phase-locked to input video when logic 1.
TEXT SIGNAL QUALITY	If a good teletext signal is being received then logic 1.
ROM VER R0 to R4	Indicated language/ROM variant. For Western European is logic 0. R3 and R4 are set HIGH if R13 D6 is logic 1.
625/525 SYNC	If the input video is a 525 line signal then logic 1.
R12 ADVANCED CONTROL 2A - does not auto-increment	
S0 to S3, H0 to H3	Each acquisition channel can be programmed to process its page in one of four ways as shown in Table 12.

Integrated Video input processor and Teletext decoder (IVT1.8*)

SAA5281

REGISTER BIT D0 TO D7	FUNCTION
R13 ADVANCED CONTROL 2B - does not auto-increment	
AUTO DISPLAY PKT X/24	Status row will show the contents of the row of the extension memory (packet 24) when logic 1.
DISABLE PKT X/26	Output taken from processing engine written to the display memory when logic 0. Operates independent of the acquisition.
HAM CHECK 24 : 18	When logic 1 all packet 26 data is stored in extension memory unchecked.
POINTS ENABLE	Enable for acquisition pointers when logic 1.
VPS ENABLE	VPS acquisition enabled when logic 1.
MESHING ENABLE	Enables meshing display function in box mode.
CURSOR FREEZE/ DEVICE IDENT	When logic 1, cursor position not updated even if active row and column change. This bit will also cause R3 and R4 of the ROM code in Register R11B to be set HIGH. This allows software to identify the device as an IVT1.8*. An internal '1.8 mode' flag is also set, which enables the operation of ROD4, R4D4 and the subtitle bit in R3.
ENHANC MODE	When logic 1, extension packet data is mapped into the last chapter. Only packet 24, 27/0 and 8/30 are stored. Chapters 0 to 6 can then be used for page storage. If extension packets are not enabled, 8 pages are stored as normal, but X/26 engine is enabled.

Note

1. These functions have IN and OUT referring to inside and outside the boxing function respectively.

Table 9 $\overline{\text{ODD}}$ /EVEN selection

$\overline{\text{ODD}}$ EVEN	DISABLE $\overline{\text{ODD}}$ EVEN	RESULT
0	0	$\overline{\text{ODD}}$ /EVEN output continuous
0	1	$\overline{\text{ODD}}$ /EVEN statically LOW
1	1	$\overline{\text{ODD}}$ /EVEN active only when no TV picture displayed
1	1	$\overline{\text{DV}}$ output to indicate reception of error-free 8/30/format 2 packet or VPS line

Table 10 Interlace/non-interlace 312/313 line control and $\overline{\text{ODD}}$ /EVEN field detection option

TCS ON FFB MODE ⁽¹⁾	T1	T0	RESULT
X	0	0	interlaced 312.5/312.5 lines
X	0	1	non-interlaced 312/313 lines (note 2)
X	1	0	non-interlaced 312/313 lines (note 2)
0	1	1	SCS (scan composite sync) mode: FFB leading edge in first broad pulse of field
1	1	1	SCS (scan composite sync) mode: FFB leading edge in second broad pulse of field

Notes

1. X = don't care.
2. Reverts to interlaced mode if a newflash or subtitle is being displayed.

Integrated Video input processor and Teletext decoder (IVT1.8*)

SAA5281

Table 11 Register map for page requests (R3); notes 1 to 6

START COLUMN	PRD4	PRD3	PRD2	PRD1	PRD0
0	DO CARE Magazine	$\overline{\text{HOLD}}$	MAG2	MAG1	MAG0
1	DO CARE Page tens	PT3	PT2	PT1	PT0
2	DO CARE Page units	PU3	PU2	PU1	PU0
3	DO CARE Hours tens	SUBTITLE	X	HT1	HT0
4	DO CARE Hours units	HU3	HU2	HU1	HU0
5	DO CARE Minutes tens	X	MT2	MT1	MT0
6	DO CARE Minutes units	MU3	MU2	MU1	MU0
7	X	X	CH2	CH1	CH0

Notes

1. Abbreviations are as given in Table 6 except for DO CARE bits and CH = chapter address for acquisition chapter.
2. When the DO CARE bit is set to logic 1 this means the corresponding digit is to be taken into account for page requests. If the DO CARE bit is set to logic 0 the digit is ignored. This allows, for example, normal or timed page selection.
3. If $\overline{\text{HOLD}}$ is set LOW, the page is held and not updated.
4. Columns auto-increment on successive I²C-bus transmission bytes.
5. The SUBTITLE bit is only present when the device is in '1.8 mode' (i.e. R13D6 has been set HIGH).
6. X = don't care.

Table 12 Acquisition channel programming

H0 to H3 ⁽¹⁾	S0 to S3 ⁽¹⁾	CHECKING ALGORITHM FOR ACQUISITION CHANNEL X
0	0	7-bit + parity for whole page
0	1	8-bit for whole page
1	0	8/4 Hamming check for whole page
1	1	mixed 8/4 Hamming (columns 0 to 7, 20 to 27) and 7-bit + parity (columns 8 to 19, 28 to 39)

Note

1. These register bits operate in conjunction with $\overline{7+P}$ /8-BIT (Register 1, Bit D6) which will over-ride the choice of data checker if set, setting all channels to 8-bit only. If this bit is not set H0 to H3 and S0 to S3 will determine the data checking (default to 7-bit + parity).

Integrated Video input processor and
Teletext decoder (IVT1.8*)

SAA5281

CLOCK SYSTEMS

Crystal oscillator

The crystal is a conventional Colpitts 3-pin design operating at 27 MHz. The oscillator is sinusoidal and linear, with a controlled output amplitude. This reduces the radiated and conducted level of the 27 MHz fundamental

frequency, and reduces the power dissipation in the quartz crystal. It is capable of oscillating with both fundamental and third overtone mode crystals. External components should be used to suppress the fundamental output of the third overtone as illustrated in Fig.13. The crystal characteristics are given in Table 13.

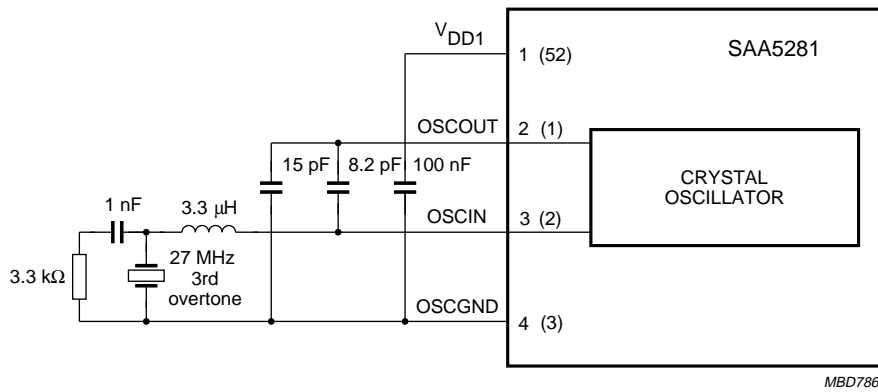

Fig.13 Crystal oscillator application diagram for SOT240-1; pins in parenthesis are for SOT247-1.

Table 13 Crystal characteristics (see Fig.13)

SYMBOL	PARAMETER	TYP.	MAX.	UNIT
Crystal (27 MHz, 3rd overtone)				
C1	series capacitance	1.7	–	pF
C0	parallel capacitance	5.2	–	pF
C _L	load capacitance	20	–	pF
R _r	resonance resistance	–	50	Ω
R1	series resistance	20	–	Ω
X _a	ageing	–	±5 × 10 ⁻⁶	year ⁻¹
X _j	adjustment tolerance	–	±25 × 10 ⁻⁶	
X _d	drift	–	±25 × 10 ⁻⁶	

Integrated Video input processor and Teletext decoder (IVT1.8*)

SAA5281

CHARACTER SETS

The WST specification allows the selection of national character sets via the page header transmission bits, C12 to C14. The basic 96 character sets differ only in 13 national option characters as indicated in the Tables 21, 22 and 23 with reference to their table position in the basic character matrix illustrated in Table 20. The IVT1.8* automatically decodes transmission bits C12 to C14. Tables 14, 15 and 16 illustrate the character matrixes.

Character bytes are listed as transmitted from b1 to b7.

Meshing

This is an alternative method of displaying teletext subtitles, or similar boxed text superimposed on the TV picture and operates by showing reduced contrast TV pictures in place of the (black) background within the boxed area. The Meshing effect is produced by toggling the BLAN signal from IVT at pixel rate. By starting at the same point each field, and toggling the start position each line, a chequered pattern will result. This allows movement to be seen behind the text information. The MESH OFF/ON bit in Register 13 D5 controls this function. Normally at zero, compatibility with IVT1.0 is maintained.

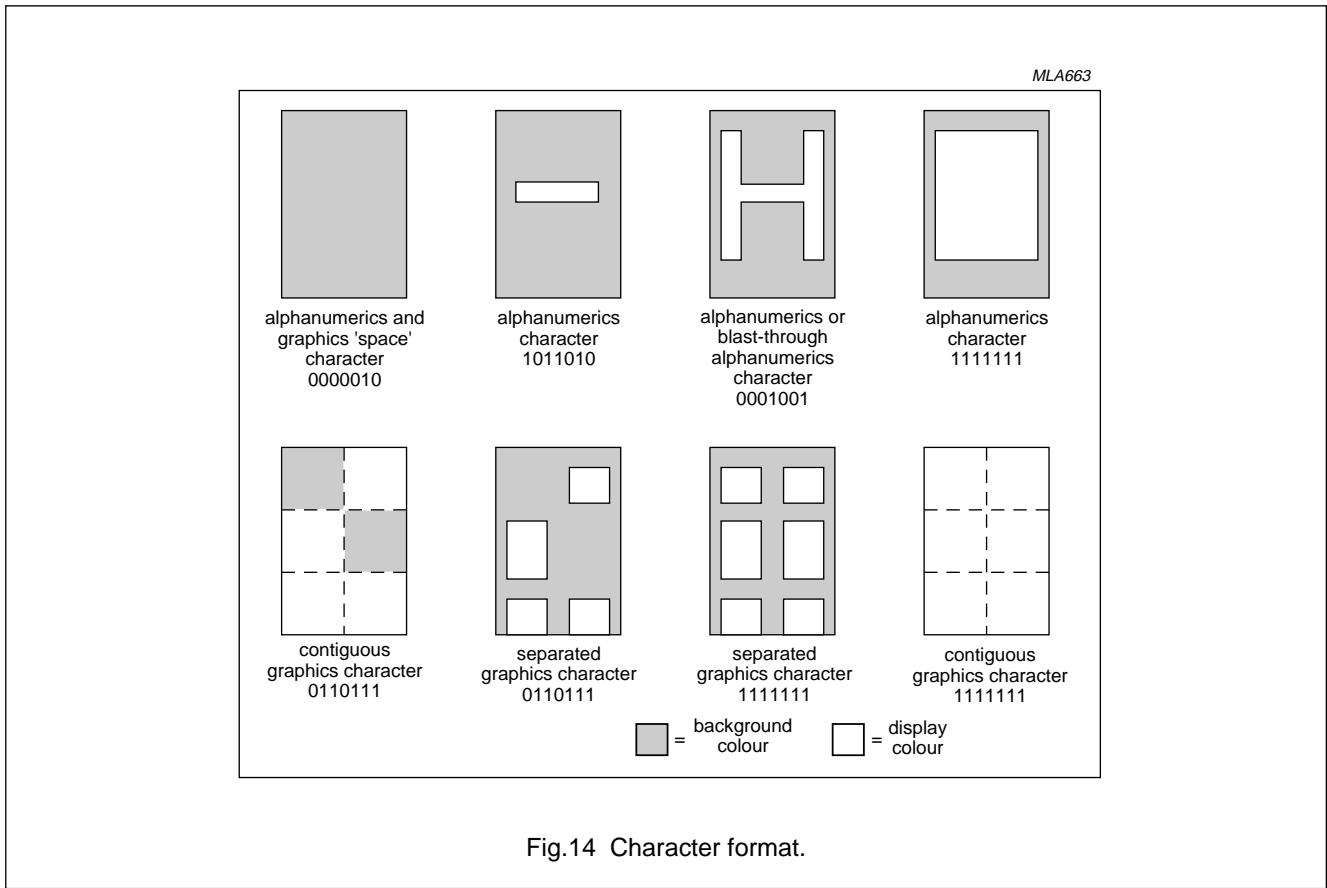

Integrated Video input processor and Teletext decoder (IVT1.8*)

SAA5281

Table 14 SAA5281P/E character data input decoding, West European languages; notes 1 to 9
For character version number (11000) see Register 11B.

BITS	b ₈ →				b ₇ →				b ₆ →				b ₅ →				b ₄ b ₃ b ₂ b ₁			
	0	0	0 or 1	0	0 or 1	0	0	0	0	1	0	0	0	1	0	1	0	1	1	1
row	column	0	1	2	2a	3	3a	4	5	6	6a	7	7a	8	9	12	13	14	15	
0 0 0 0	0	alpha - numerics black	graphics black			0		Š P °		p		@	É	é	à	i	Á			
0 0 0 1	1	alpha - numerics red	graphics red	!		1		A Q a		q		—	é	ù	è	ó	À			
0 0 1 0	2	alpha - numerics green	graphics green	”		2		B R b		r		¼	ä	à	ä	ü	È			
0 0 1 1	3	alpha - numerics yellow	graphics yellow	#		3		C S c		s		€	#	€	é	ç	Í			
0 1 0 0	4	alpha - numerics blue	graphics blue	\$		4		D T d		t		\$	X	\$	i	\$	Ï			
0 1 0 1	5	alpha - numerics magenta	graphics magenta	%		5		E U e		u		€	€	ä	Ä	ø	ó			
0 1 1 0	6	alpha - numerics cyan	graphics cyan	&		6		F V f		v		€	€	ö	ö	ø	ò			
0 1 1 1	7	alpha - numerics white ⁽²⁾	graphics white	'		7		G W g		w		?	€	·	Ç	Ñ	Ú			
1 0 0 0	8	flash	conceal display	(8		H X h		x			ö	ö	ö	ñ	æ			
1 0 0 1	9	steady ⁽²⁾	contiguous graphics ⁽²⁾)		9		I Y i		y		¾	ä	é	ù	è	Æ			
1 0 1 0	10	end box ⁽²⁾	separated graphics	*		:		J Z j		z		÷	ü	i	ç	à	ð			
1 0 1 1	11	start box	ESC ⁽¹⁾	+		;		K Ä k		ä		←	Ä	°	ë	á	Ð			
1 1 0 0	12	normal height ⁽²⁾	black back - ground ⁽²⁾	,		<		L Ö l		ö		½	ö	ç	ë	é	ø			
1 1 0 1	13	double height	new back - ground	-		=		M Ü m		ü		→	À	→	ù	í	∅			
1 1 1 0	14	SO ⁽¹⁾	hold graphics	.		>		N ^ n		ß		↑	Ü	↑	î	ó	þ			
1 1 1 1	15	SI ⁽¹⁾	release graphics ⁽²⁾	/		?		O _ o		■		#	_	#	#	ú	þ			

MBA429

Integrated Video input processor and Teletext decoder (IVT1.8*)

SAA5281

Table 15 SAA5281P/H character data input decoding, East European languages; notes 1 to 9
For character version number (11001) see Register 11B.

BITS b ₈ b ₇ b ₆ b ₅ b ₄ b ₃ b ₂ b ₁	row w	column																	
		0	1	2	2a	3	3a	4	5	6	6a	7	7a	8	9	12	13	14	15
0 0 0 0	0	alpha - numerics black	graphics black			0	.	T	P	t	.	p	.	S	É	Č	ř	Č	Ů
0 0 0 1	1	alpha - numerics red	graphics red	!	°	1	°	A	Q	a	°	q	°	°	é	é	ř	č	ď
0 0 1 0	2	alpha - numerics green	graphics green	”	°	2	°	B	R	b	°	r	°	ä	ä	á	ž	č	ď
0 0 1 1	3	alpha - numerics yellow	graphics yellow	#	°	3	°	C	S	c	°	s	°	ö	ü	é	ř	ž	ř
0 1 0 0	4	alpha - numerics blue	graphics blue	⌘	°	4	°	D	T	d	°	t	°	\$	⌘	ü	ñ	½	č
0 1 0 1	5	alpha - numerics magenta	graphics magenta	%	°	5	°	E	U	e	°	u	°	€	€	Á	Ö	Ö	İ
0 1 1 0	6	alpha - numerics cyan	graphics cyan	&	°	6	°	F	V	f	°	v	°	⊗	⊗	É	Ó	Ö	č
0 1 1 1	7	alpha - numerics white ⁽²⁾	graphics white	'	°	7	°	G	W	g	°	w	°	⊗	⊗	í	Ü	Ü	Ň
1 0 0 0	8	flash	conceal display	(°	8	°	H	X	h	°	x	°	ö	ö	ě	š	ž	ň
1 0 0 1	9	steady	contiguous graphics ⁽²⁾)	°	9	°	I	Y	i	°	y	°	ü	ä	ú	ž	đ	ň
1 0 1 0	10	end box	separated graphics ⁽²⁾	*	°	:	°	J	Z	j	°	z	°	β	ü	š	ž	š	ř
1 0 1 1	11	start box	ESC ⁽¹⁾	+	°	;	°	K	Ā	k	°	ā	°	Ā	Ā	č	ž	č	ř
1 1 0 0	12	normal height	black back-ground ⁽²⁾	,	°	<	°	L	S	l	°	s	°	ö	ö	ž	š	ž	ř
1 1 0 1	13	double height	new back-ground	-	°	=	°	M	Ā	m	°	ā	°	Ü	Ā	ý	ž	đ	ř
1 1 1 0	14	SO ⁽¹⁾	hold graphics	.	°	>	°	N	î	n	°	î	°	^	Ü	í	č	š	ý
1 1 1 1	15	SI ⁽¹⁾	release graphics ⁽²⁾	/	°	?	°	O	ı	o	°	ı	°	ı	ı	ř	ó	ě	ě

MLA961

Integrated Video input processor and
Teletext decoder (IVT1.8*)

SAA5281

Table 16 SAA5281P/T character data input decoding, West European and Turkish languages; notes 1 to 9
For character version number (11010) see Register 11B.

BITS	row				column																		
	b ₈	b ₇	b ₆	b ₅	0	1	2	2a	3	3a	4	5	6	6a	7	7a	8	9	12	13	14	15	
0 0 0 0	0	0	0	0	alpha - numerics black	graphics black			0	°	Š	P	°	°	p	°	@	ı	é	à	ı	Á	
0 0 0 1	0	0	0	1	alpha - numerics red	graphics red	!	°	1	°	A	Q	a	°	q	°	—	ı	ù	è	ı	À	
0 0 1 0	0	0	1	0	alpha - numerics green	graphics green	”	°	2	°	B	R	b	°	r	°	¼	š	à	à	ü	È	
0 0 1 1	0	0	1	1	alpha - numerics yellow	graphics yellow	#	°	3	°	C	S	c	°	s	°	¾	ı	é	é	ç	İ	
0 1 0 0	0	1	0	0	alpha - numerics blue	graphics blue	\$	°	4	°	D	T	d	°	t	°	\$	ğ	\$	ı	\$	İ	
0 1 0 1	0	1	0	1	alpha - numerics magenta	graphics magenta	%	°	5	°	E	U	e	°	u	°	€	ı	ä	ä	œ	ó	
0 1 1 0	0	1	1	0	alpha - numerics cyan	graphics cyan	&	°	6	°	F	V	f	°	v	°	€	ı	ö	ö	œ	ò	
0 1 1 1	0	1	1	1	alpha - numerics white	graphics white	'	°	7	°	G	W	g	°	w	°	€	ı	ç	ç	Ç	Ú	
1 0 0 0	1	0	0	0	flash	conceal display	(°	8	°	H	X	h	°	x	°		ö	ö	ö	ñ	ı	
1 0 0 1	1	0	0	1	steady	contiguous graphics)	°	9	°	I	Y	i	°	y	°	¾	ç	è	ù	è	ù	
1 0 1 0	1	0	1	0	end box	separated graphics	*	°	:	°	J	Z	j	°	z	°	÷	ü	ı	ç	à	↓	
1 0 1 1	1	0	1	1	start box	ESC	+	°	;	°	K	Ä	k	°	ä	°	←	š	°	è	á	É	
1 1 0 0	1	1	0	0	normal height	black back-ground	,	°	<	°	L	Ö	l	°	ö	°	½	ö	ç	è	è	ä	
1 1 0 1	1	1	0	1	double height	new back-ground	-	°	=	°	M	Ü	m	°	ü	°	→	ç	→	ù	ı	Ò	
1 1 1 0	1	1	1	0	SO	hold graphics	.	°	>	°	N	^	n	°	β	°	↑	ü	↑	ı	ó	Ä	
1 1 1 1	1	1	1	1	SI	release graphics	/	°	?	°	O	_	o	°	■	°	#	ç	#	#	ú	İ	

MBA431

Integrated Video input processor and
Teletext decoder (IVT1.8*)

SAA5281

Table 18 SAA5281P/L character data input decoding, Arabic and Hebrew languages; notes 1 to 9
For character version number (00100) see Register 11B.

BITS	b ₈ →				b ₇ →				b ₆ →				b ₅ →				b ₄ b ₃ b ₂ b ₁			
	0	0	0 or 1	0	0 or 1	0	0	0	0	0	0 or 1	0	0 or 1	0	0 or 1	1	1	1	1	1
row	column	0	1	2	2a	3	3a	4	5	6	6a	7	7a	8	9	12	13	14	15	
0 0 0 0	0	alpha - numerics black	graphics black			0	.	@	P	N	.	J	.	ع	.	ا	ا	ا	ا	
0 0 0 1	1	alpha - numerics red	graphics red	!	.	1	.	A	Q	I	.	O	.	ع	ا	ع	ا	ا	ا	
0 0 1 0	2	alpha - numerics green	graphics green	"	.	2	.	B	R	ا	.	U	.	T	ا	ا	ا	ا	ا	
0 0 1 1	3	alpha - numerics yellow	graphics yellow	£	.	3	.	C	S	T	.	ا	.	ا	ا	ا	ا	ا	ا	
0 1 0 0	4	alpha - numerics blue	graphics blue	\$.	4	.	D	T	ا	.	ا	.	ا	ع	ا	ا	ا	ا	
0 1 0 1	5	alpha - numerics magenta	graphics magenta	%	.	5	.	E	U	ا	.	ا	.	ا	ا	ا	ا	ا	ا	
0 1 1 0	6	alpha - numerics cyan	graphics cyan	&	.	6	.	F	V	ا	.	ا	.	ا	ا	ا	ا	ا	ا	
0 1 1 1	7	alpha - numerics white ⁽²⁾	graphics white	'	.	7	.	G	W	ا	.	ا	.	ا	ا	ا	ا	ا	ا	
1 0 0 0	8	flash	conceal display	(.	8	.	H	X	ا	.	ا	.)	ا	ا	ا	ا	ا	
1 0 0 1	9	steady ⁽²⁾	contiguous graphics ⁽²⁾)	.	9	.	I	Y	'	.	ا	.	(ا	ا	ا	ا	ا	
1 0 1 0	10	end box ⁽²⁾	separated graphics	*	.	:	.	J	Z	ا	.	ا	.	ا	ا	ا	ا	ا	ا	
1 0 1 1	11	start box	TWIST	+	.	;	.	K	←	ا	.	ا	.	ا	ا	ا	ا	ا	ا	
1 1 0 0	12	normal height ⁽²⁾	black back-ground ⁽²⁾	,	.	<	.	L	½	ا	.	ا	.	>	ا	ا	ا	ا	ا	
1 1 0 1	13	double height	new back-ground	-	.	=	.	M	→	ا	.	ا	.	ا	ا	ا	ا	ا	ا	
1 1 1 0	14	SO ⁽¹⁾	hold graphics	.	.	>	.	N	↑	ا	.	ا	.	<	ا	ا	ا	ا	ا	
1 1 1 1	15	SI ⁽¹⁾	release graphics ⁽²⁾	/	.	?	.	O	#	ا	.	ا	.	?	ا	ا	ا	ا	ا	

MLA963 - 1

Integrated Video input processor and Teletext decoder (IVT1.8*)

SAA5281

Table 19 SAA5281P/K character data input decoding, French and Arabic languages; notes 1 to 9
For character version number (00100) see Register 11B.

BITS	column		row																
	0	1	2	2a	3	3a	4	5	6	6a	7	7a	8	9	12	13	14	15	
b ₈ →	0	0	0 or 1	0	0 or 1	0	0	0	0	0 or 1	0	0 or 1	1	1	1	1	1	1	1
b ₇ →	0	0	0	0	0	0	0	0	0	0	0	0	1	0	0	0	0	0	0
b ₆ →	0	0	1	1	1	1	0	0	1	1	1	1	0	0	0	0	1	1	1
b ₅ →	0	1	0	0	1	1	0	1	0	0	1	1	0	1	0	0	1	0	1
b ₄ ↓																			
b ₃ ↓																			
b ₂ ↓																			
b ₁ ↓																			
row	0	1	2	2a	3	3a	4	5	6	6a	7	7a	8	9	12	13	14	15	
0 0 0 0	alpha - numerics black	graphics black			0	à	P	è		p		ع	ا	ة	ا	ا	ا	ا	ا
0 0 0 1	alpha - numerics red	graphics red	!		1	A	Q	a		q		ع	ا	ع	ا	ا	ا	ا	ا
0 0 1 0	alpha - numerics green	graphics green	”		2	B	R	b		r		ا	ا	ا	ا	ا	ا	ا	ا
0 0 1 1	alpha - numerics yellow	graphics yellow	é		3	C	S	c		s		ا	ا	ا	ا	ا	ا	ا	ا
0 1 0 0	alpha - numerics blue	graphics blue	ï		4	D	T	d		t		ا	ا	ا	ا	ا	ا	ا	ا
0 1 0 1	alpha - numerics magenta	graphics magenta	%		5	E	U	e		u		ا	ا	ا	ا	ا	ا	ا	ا
0 1 1 0	alpha - numerics cyan	graphics cyan	&		6	F	V	f		v		ا	ا	ا	ا	ا	ا	ا	ا
0 1 1 1	alpha - numerics white ⁽²⁾	graphics white	'		7	G	W	g		w		ا	ا	ا	ا	ا	ا	ا	ا
1 0 0 0	flash	conceal display	(8	H	X	h		x)	ا	ا	ا	ا	ا	ا	ا
1 0 0 1	steady ⁽²⁾	contiguous graphics ⁽²⁾)		9	I	Y	i		y		(ا	ا	ا	ا	ا	ا	ا
1 0 1 0	end box ⁽²⁾	separated graphics	*		:	J	Z	j		z		ا	ا	ا	ا	ا	ا	ا	ا
1 0 1 1	start box	TWIST	+		;	K	ë	k		â		ا	ا	ا	ا	ا	ا	ا	ا
1 1 0 0	normal height ⁽²⁾	black back-ground ⁽²⁾	,		<	L	è	l		ô		>	ا	ا	ا	ا	ا	ا	ا
1 1 0 1	double height	new back-ground	-		=	M	ù	m		û		ا	ا	ا	ا	ا	ا	ا	ا
1 1 1 0	SO ⁽¹⁾	hold graphics	.		>	N	î	n		ç		<	ا	ا	ا	ا	ا	ا	ا
1 1 1 1	SI ⁽¹⁾	release graphics ⁽²⁾	/		?	O	#	o		■		?	ا	ا	ا	ا	ا	ا	ا

MLA972 - 1

Integrated Video input processor and Teletext decoder (IVT1.8*)

SAA5281

Notes to Tables 14, 15, 16, 17, 18 and 19

1. These control characters are reserved for compatibility with other data codes.
2. These control characters are presumed before each row begins.
3. Control characters shown in Columns 0 and 1 are normally displayed as spaces.
4. Characters may be referred to by column and row (for example 2/5 refers to %).
5. Black represents displayed colour. White represents background.
6. The SAA5281 national option characters are illustrated in Tables 21, 22 and 23.
7. Characters 8/6, 8/7, 9/5, 9/6 and 9/7 are special characters for combining with character 8/5 (E, H and T codes only). Characters 5/12, 5/13, 5/14 and 5/15 are combined with 5/11 (S code only).
8. National option characters will be displayed according to the setting of control bits C12 to C14. These will be mapped into the basic code table into positions shown in Tables 21, 22 and 23.
9. Columns 2a, 3a, 6a and 7a are displayed in graphics mode.

Integrated Video input processor and
Teletext decoder (IVT1.8*)

SAA5281

Table 20 SAA5281 basic character matrix; note 1

2/0		2/1	!	2/2	?	2/3	NC	2/4	NC	2/5	%	2/6	8	2/7	.
2/8	ç	2/9	ç	2/10	*	2/11	+	2/12	,	2/13		2/14	.	2/15	/
3/0	ø	3/1	l	3/2	n	3/3	m	3/4	v	3/5	u	3/6	o	3/7	z
3/8	ß	3/9	ß	3/10	:	3/11	;	3/12	y	3/13	=	3/14	^	3/15	ç
4/0	NC	4/1	é	4/2	ø	4/3	ú	4/4	ó	4/5	é	4/6	é	4/7	é
4/8	h	4/9	h	4/10	j	4/11	k	4/12	l	4/13	z	4/14	z	4/15	o
5/0	e	5/1	ø	5/2	r	5/3	s	5/4	t	5/5	o	5/6	>	5/7	m
5/8	x	5/9	y	5/10	n	5/11	NC	5/12	NC	5/13	NC	5/14	NC	5/15	NC
6/0	NC	6/1	è	6/2	ø	6/3	u	6/4	o	6/5	o	6/6	4	6/7	o
6/8	u	6/9	i	6/10	j	6/11	y	6/12	t	6/13	è	6/15	o	6/15	o
7/0	ø	7/1	ø	7/2	l	7/3	s	7/4	t	7/5	o	7/6	>	7/7	ø
7/8	x	7/9	y	7/10	n	7/11	NC	7/12	NC	7/13	NC	7/14	NC	7/15	

Note

1. Where NC = national option character position.

Integrated Video input processor and
Teletext decoder (IVT1.8*)

SAA5281

Table 21 SAA5281P/E national option character set

LANGUAGE	PHCB ⁽¹⁾			CHARACTER POSITION (COLUMN / ROW)												
	C12	C13	C14	2/3	2/4	4/0	5/11	5/12	5/13	5/14	5/15	6/0	7/11	7/12	7/13	7/14
ENGLISH	0	0	0	£	\$	@	←	½	→	↑	#	—	¼		¾	÷
GERMAN	0	0	1	#	\$	§	Ä	Ö	Ü	^	_	°	ä	ö	ü	ß
SWEDISH	0	1	0	#	×	É	Ä	Ö	Å	Ü	_	é	ä	ö	å	ü
ITALIAN	0	1	1	£	\$	é	°	ç	→	↑	#	ù	à	ó	è	ì
FRENCH	1	0	0	é	ï	à	è	ë	ù	î	#	ê	â	ô	û	ç
SPANISH	1	0	1	ç	\$	í	á	é	í	ó	ú	ó	ü	ñ	è	à

MLB458

(1) PHCB are the Page Header Control Bits. Other combinations default to English.

Table 22 SAA5281P/H national option character set

LANGUAGE	PHCB ⁽¹⁾			CHARACTER POSITION (COLUMN / ROW)												
	C12	C13	C14	2/3	2/4	4/0	5/11	5/12	5/13	5/14	5/15	6/0	7/11	7/12	7/13	7/14
POLISH	0	0	0	#	ń	ą	z	ś	ł	ć	ó	ę	ź	ś	ż	ź
GERMAN	0	0	1	#	\$	§	Ä	Ö	Ü	^	_	°	ä	ö	ü	ß
SWEDISH	0	1	0	#	×	É	Ä	Ö	Å	Ü	_	é	ä	ö	å	ü
SERBO-CROAT	1	0	1	#	½	č	ć	ž	đ	š	ë	č	ć	ž	đ	š
CZECHOSLOVAKIA	1	1	0	#	ů	č	ř	ž	ý	í	ř	é	á	ě	ú	š
RUMANIAN	1	1	1	#	×	Ț	Ă	Ș	Ă	Î	ı	ț	ă	ș	ă	î

MLA966

(1) PHCB are the Page Header Control Bits. Other combinations default to German. Only the above characters change with the PHCB. All other characters in the basic set are shown in Table 20.

Integrated Video input processor and
Teletext decoder (IVT1.8*)

SAA5281

Table 23 SAA5281P/T national option character set

LANGUAGE	PHCB ⁽¹⁾			CHARACTER POSITION (COLUMN / ROW)												
	C12	C13	C14	2 / 3	2 / 4	4 / 0	5 / 11	5 / 12	5 / 13	5 / 14	5 / 15	6 / 0	7 / 11	7 / 12	7 / 13	7 / 14
ENGLISH	0	0	0	£	\$	@	←	½	→	↑	#	—	¼		¾	÷
GERMAN	0	0	1	#	\$	§	Ä	Ö	Ü	^	_	°	ä	ö	ü	ß
TURKISH	1	1	0	ı	ğ	İ	Ş	Ö	Ç	Ü	Ğ	ı	Ş	ö	ç	ü
ITALIAN	0	1	1	£	\$	é	°	ç	→	↑	#	ù	à	ò	é	ì
FRENCH	1	0	0	é	ï	à	ë	è	ù	î	#	è	â	ô	û	ç
SPANISH	1	0	1	ç	\$	i	á	é	í	ó	ú	ó	ü	ñ	é	á

MBA430

(1) PHCB are the Page Header Control Bits. Other combinations default to English. Only the above characters change with the PHCB. All other characters in the basic set are shown in Table 20.

Integrated Video input processor and
Teletext decoder (IVT1.8*)

SAA5281

Table 24 SAA5281P/R national option character set

LANGUAGE	PHCB ⁽¹⁾			CHARACTER POSITION (COLUMN / ROW)												
	C12	C13	C14	2 / 3	2 / 4	4 / 0	5 / 11	5 / 12	5 / 13	5 / 14	5 / 15	6 / 0	7 / 11	7 / 12	7 / 13	7 / 14
ESTONIAN	0	1	0	#	õ	š	ä	ö	ž	ü	õ	š	ä	ö	ž	ü
LETTISH / LITHUANIAN	0	1	1	#	\$	š	ē	ŗ	ž	č	ū	š	ŗ	ų	ž	į
RUSSIAN	1	0	0		2	3	4	5	6	7						
			0		0	Ю	П	ю	п							
		1	!	1	А	Я	а	я								
		2	"	2	Б	Р	б	р								
		3	#	3	Ц	С	ц	с								
		4	\$	4	Д	Т	д	т								
		5	%	5	Е	У	е	у								
		6	ы	6	Ф	Ж	ф	ж								
		7	'	7	Г	В	г	в								
		8	(8	Х	Ь	х	ь								
		9)	9	И	Ь	и	ь								
		10	ж	:	И	З	и	э								
		11	+	;	К	Ш	к	ш								
		12	,	<	Л	Э	л	э								
		13	-	=	М	Щ	м	щ								
		14	.	>	Н	Ч	н	ч								
		15	/	?	О	Ы	о	■								

MEA597

(1) PHCB are the Page Header Control Bits. Other combinations default to Estonian.

Integrated Video input processor and
Teletext decoder (IVT1.8*)

SAA5281

Table 25 SAA5281P/K national option character set

	2	3	4	5	6	7		2	3	4	5	6	7
0	□	0	à	P	è	p	0	□	0	ة	ا	ا	ا
1	!	1	A	Q	a	q	1	!	1	ء	و	ف	خ
2	”	2	B	R	b	r	2	”	2	ج	ز	ق	غ
3	é	3	C	S	c	s	3	£	3	ب	س	ك	غ
4	ï	4	D	T	d	t	4	\$	4	ن	ش	ل	ف
5	%	5	E	U	e	u	5	%	5	ت	ص	م	ن
6	&	6	F	V	f	v	6	ل	6	ل	ف	ن	ق
7	'	7	G	W	g	w	7	ي	7	ا	ط	ه	ك
8	(8	H	X	h	x	8)	8	ب	ظ	و	ا
9)	9	I	Y	i	y	9	(9	ة	ط	ي	ل
10	*	:	J	Z	j	z	10	*	:	ن	ظ	ي	م
11	+	;	K	ë	k	â	11	+	:	ن	ظ	ن	م
12	,	<	L	ê	l	ô	12	,	>	د	ج	ج	ن
13	-	=	M	ù	m	û	13	-	=	ن	ظ	ج	ن
14	.	>	N	î	n	ç	14	.	<	د	ج	ج	ن
15	/	?	O	#	o	■	15	/	?	ل	#	ج	■
LANGUAGE	FRENCH						ARABIC						
PHCB ⁽¹⁾ (C12, C13, C14)	1 0 0						1 1 1						

MLA968 - 1

(1) PHCB are the Page Header Control Bits. Other combinations default to French.

Integrated Video input processor and
Teletext decoder (IVT1.8*)

SAA5281

Table 26 SAA5281P/L national option character set

	2	3	4	5	6	7		2	3	4	5	6	7
0	□	0	@	P	N	J	0	□	0	أ	ب	ج	د
1	!	1	A	Q	ı	o	1	!	1	هـ	و	ز	ح
2	"	2	B	R	ا	u	2	"	2	ط	ق	ك	غ
3	£	3	C	S	T	q	3	£	3	ل	م	ن	ف
4	\$	4	D	T	h	g	4	\$	4	ی	ع	ف	ق
5	%	5	E	U	ı	ı	5	%	5	ت	ث	د	ذ
6	&	6	F	V	I	ı	6	ل	6	ا	ب	ج	د
7	'	7	G	W	h	p	7	ی	7	ا	ط	هـ	ك
8	(8	H	X	u	g	8)	8	ب	ظ	و	ا
9)	9	I	ı	'	ı	9	(9	ة	ح	ی	ل
10	*	:	J	Z	ı	ı	10	*	:	ن	ی	ی	م
11	+	;	K	←	ı	ı	11	+	:	ت	ث	د	م
12	,	<	L	½	ı	ı	12	,	>	ح	ج	ج	ز
13	-	=	M	→	o	¾	13	-	=	د	د	ی	ن
14	.	>	N	↑	ı	÷	14	.	<	د	خ	خ	لا
15	/	?	O	#	ı	■	15	/	?	ا	#	ج	■
LANGUAGE	HEBREW/ENGLISH							ARABIC					
PHCB ⁽¹⁾ (C12, C13, C14)	1 0 1							1 1 1					

MLA967

(1) PHCB are the Page Header Control Bits. Other combinations default to Hebrew English.

Integrated Video input processor and Teletext decoder (IVT1.8*)

SAA5281

APPLICATION INFORMATION

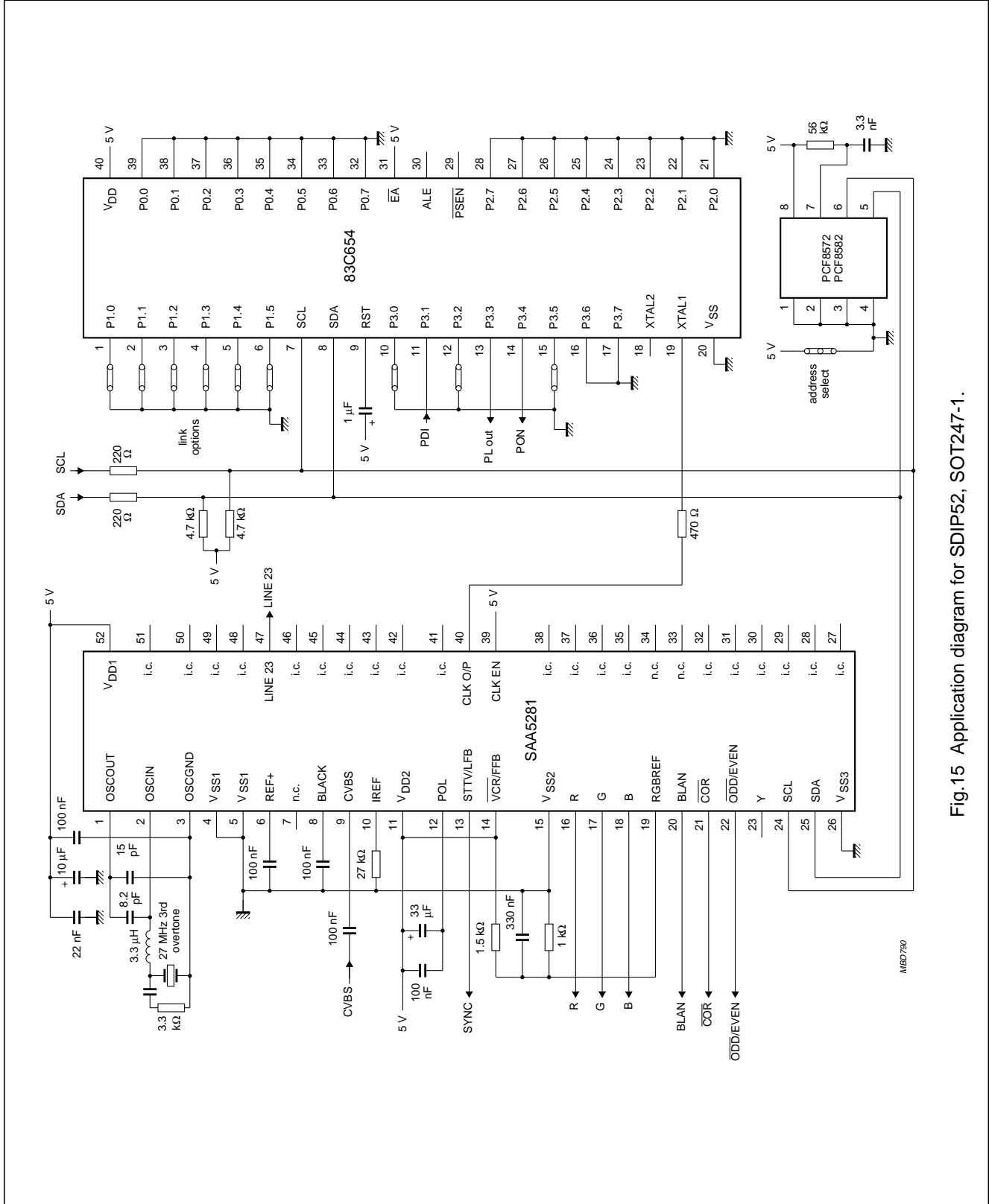

Fig.15 Application diagram for SDIP52, SOT247-1.

Integrated Video input processor and
Teletext decoder (IVT1.8*)

SAA5281

PACKAGE OUTLINES

DIP48: plastic dual in-line package; 48 leads (600 mil)

SOT240-1

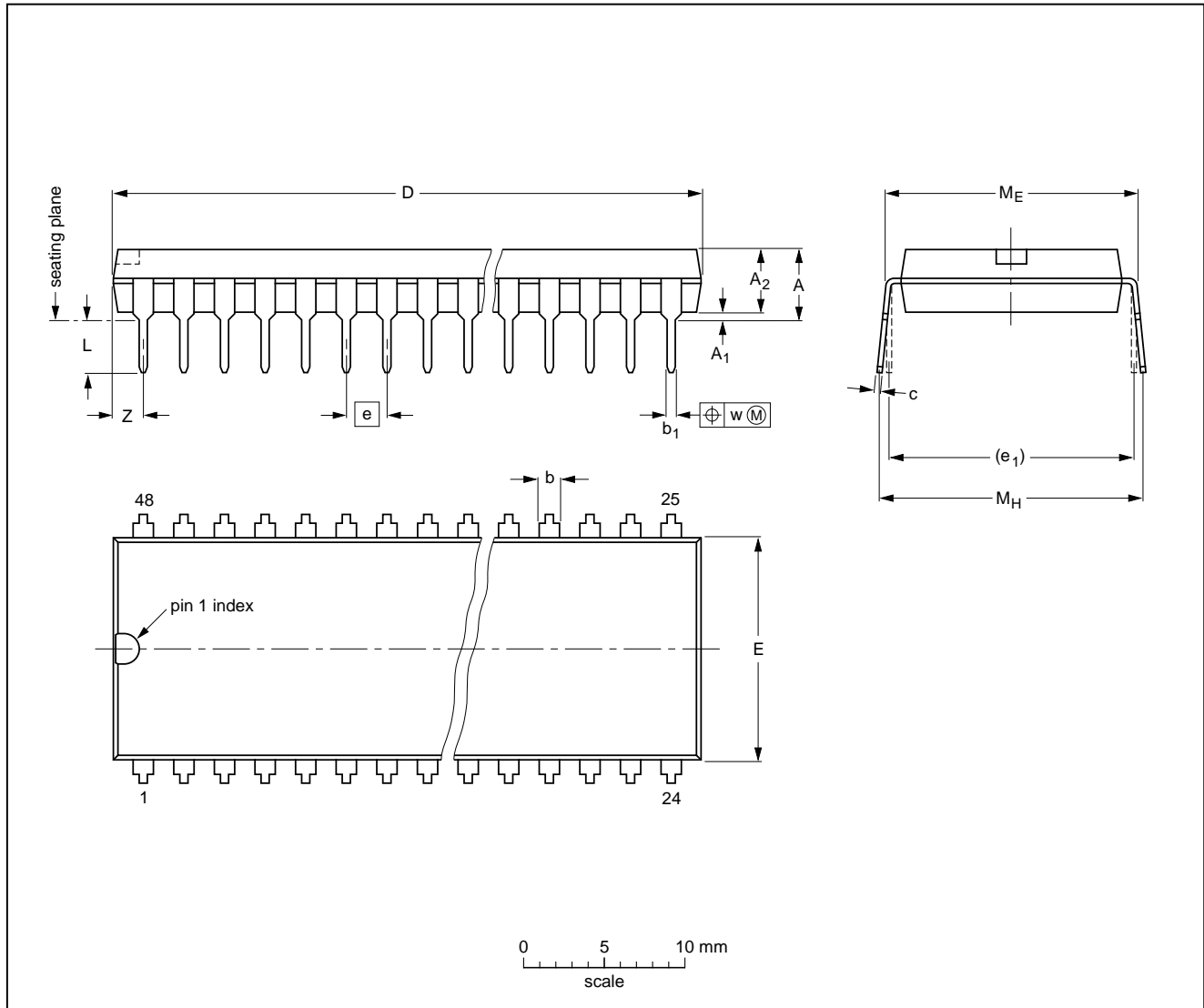

DIMENSIONS (inch dimensions are derived from the original mm dimensions)

UNIT	A max.	A ₁ min.	A ₂ max.	b	b ₁	c	D ⁽¹⁾	E ⁽¹⁾	e	e ₁	L	M _E	M _H	w	Z ⁽¹⁾ max.
mm	4.9	0.36	4.06	1.4 1.14	0.53 0.38	0.36 0.23	62.60 61.60	14.22 13.56	2.54	15.24	3.90 3.05	15.88 15.24	18.46 15.24	0.254	2.1
inches	0.19	0.014	0.16	0.055 0.045	0.021 0.015	0.014 0.009	2.46 2.42	0.56 0.53	0.10	0.60	0.15 0.12	0.63 0.60	0.73 0.60	0.01	0.083

Note

1. Plastic or metal protrusions of 0.25 mm maximum per side are not included.

OUTLINE VERSION	REFERENCES				EUROPEAN PROJECTION	ISSUE DATE
	IEC	JEDEC	EIAJ			
SOT240-1						92-11-17 95-01-25

Integrated Video input processor and
Teletext decoder (IVT1.8*)

SAA5281

SDIP52: plastic shrink dual in-line package; 52 leads (600 mil)

SOT247-1

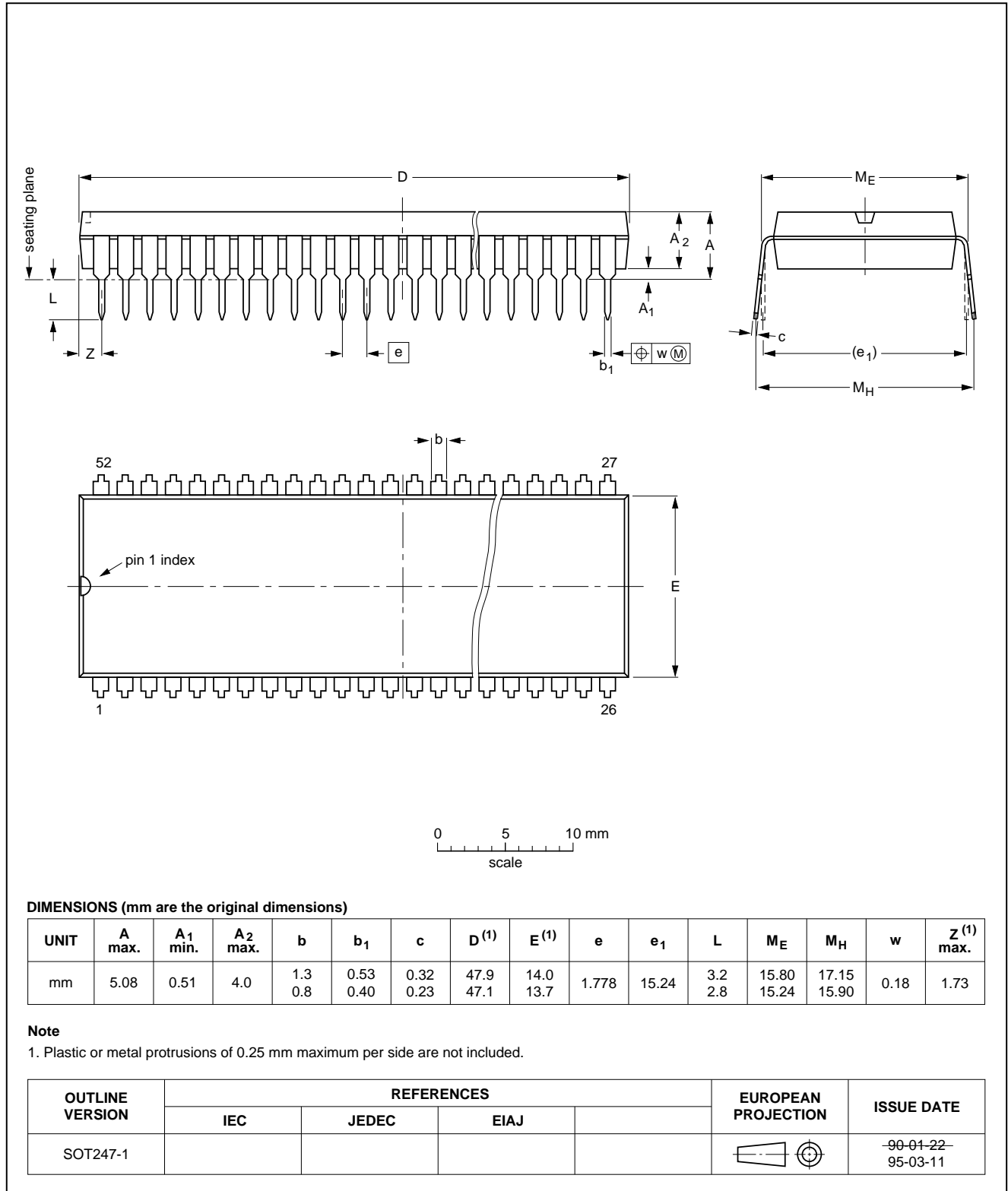

Integrated Video input processor and
Teletext decoder (IVT1.8*)

SAA5281

QFP64: plastic quad flat package; 64 leads (lead length 1.95 mm); body 14 x 20 x 2.8 mm

SOT319-2

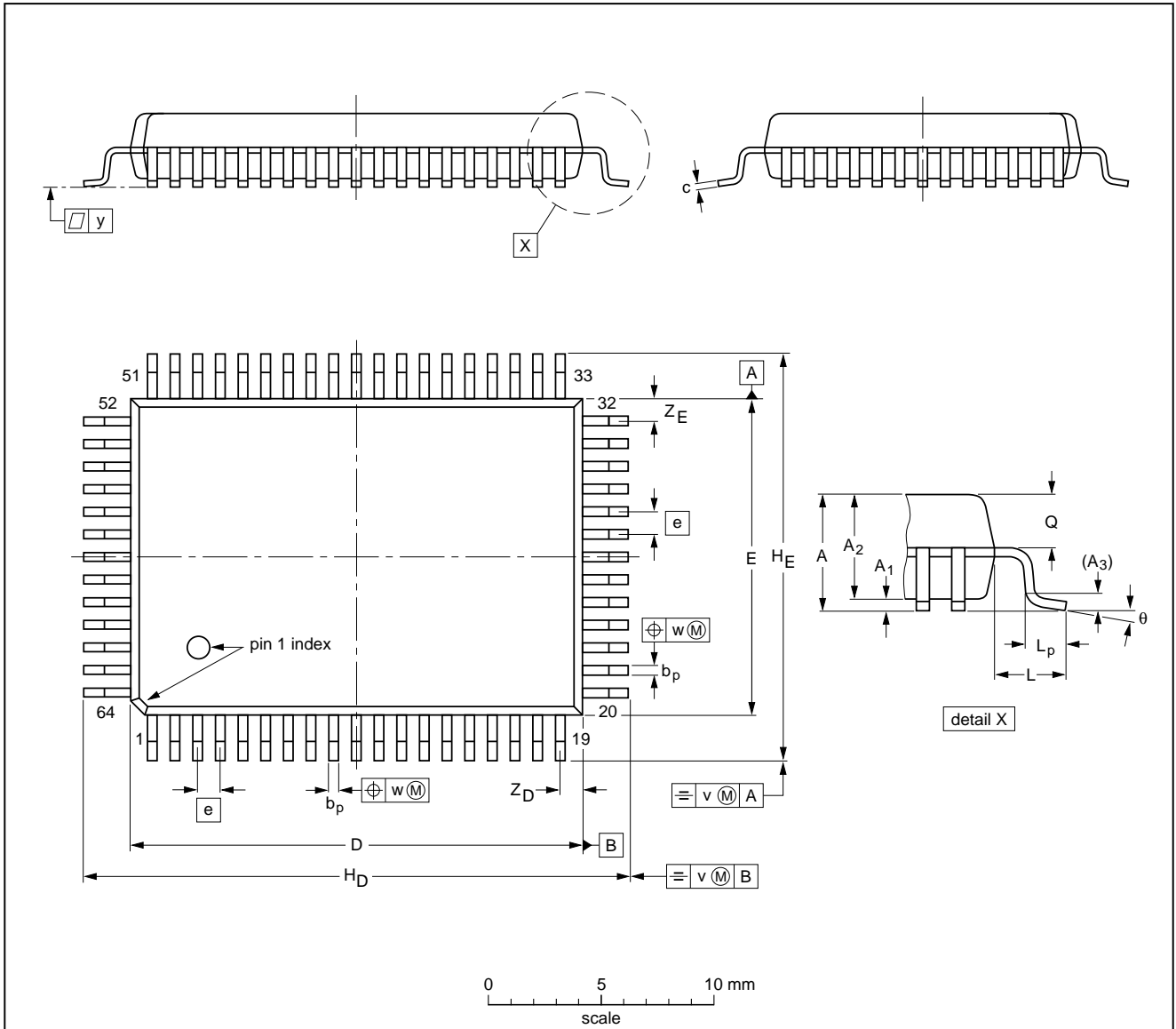

DIMENSIONS (mm are the original dimensions)

UNIT	A max.	A ₁	A ₂	A ₃	b _p	c	D ⁽¹⁾	E ⁽¹⁾	e	H _D	H _E	L	L _p	Q	v	w	y	Z _D ⁽¹⁾	Z _E ⁽¹⁾	θ
mm	3.20	0.25 0.05	2.90 2.65	0.25	0.50 0.35	0.25 0.14	20.1 19.9	14.1 13.9	1	24.2 23.6	18.2 17.6	1.95	1.0 0.6	1.4 1.2	0.2	0.2	0.1	1.2 0.8	1.2 0.8	7° 0°

Note

1. Plastic or metal protrusions of 0.25 mm maximum per side are not included.

OUTLINE VERSION	REFERENCES				EUROPEAN PROJECTION	ISSUE DATE
	IEC	JEDEC	EIAJ			
SOT319-2						92-11-17 95-02-04

Integrated Video input processor and Teletext decoder (IVT1.8*)

SAA5281

SOLDERING

Introduction

There is no soldering method that is ideal for all IC packages. Wave soldering is often preferred when through-hole and surface mounted components are mixed on one printed-circuit board. However, wave soldering is not always suitable for surface mounted ICs, or for printed-circuits with high population densities. In these situations reflow soldering is often used.

This text gives a very brief insight to a complex technology. A more in-depth account of soldering ICs can be found in our "IC Package Databook" (order code 9398 652 90011).

Soldering by dipping or by wave

The maximum permissible temperature of the solder is 260 °C; solder at this temperature must not be in contact

with the joint for more than 5 seconds. The total contact time of successive solder waves must not exceed 5 seconds.

The device may be mounted up to the seating plane, but the temperature of the plastic body must not exceed the specified maximum storage temperature ($T_{stg\ max}$). If the printed-circuit board has been pre-heated, forced cooling may be necessary immediately after soldering to keep the temperature within the permissible limit.

Repairing soldered joints

Apply a low voltage soldering iron (less than 24 V) to the lead(s) of the package, below the seating plane or not more than 2 mm above it. If the temperature of the soldering iron bit is less than 300 °C it may remain in contact for up to 10 seconds. If the bit temperature is between 300 and 400 °C, contact may be up to 5 seconds.

DEFINITIONS

Data sheet status	
Objective specification	This data sheet contains target or goal specifications for product development.
Preliminary specification	This data sheet contains preliminary data; supplementary data may be published later.
Product specification	This data sheet contains final product specifications.
Limiting values	
Limiting values given are in accordance with the Absolute Maximum Rating System (IEC 134). Stress above one or more of the limiting values may cause permanent damage to the device. These are stress ratings only and operation of the device at these or at any other conditions above those given in the Characteristics sections of the specification is not implied. Exposure to limiting values for extended periods may affect device reliability.	
Application information	
Where application information is given, it is advisory and does not form part of the specification.	

LIFE SUPPORT APPLICATIONS

These products are not designed for use in life support appliances, devices, or systems where malfunction of these products can reasonably be expected to result in personal injury. Philips customers using or selling these products for use in such applications do so at their own risk and agree to fully indemnify Philips for any damages resulting from such improper use or sale.



Purchase of Philips I²C components conveys a license under the Philips' I²C patent to use the components in the I²C system provided the system conforms to the I²C specification defined by Philips. This specification can be ordered using the code 9398 393 40011.

Integrated Video input processor and
Teletext decoder (IVT1.8*)

SAA5281

NOTES

Integrated Video input processor and
Teletext decoder (IVT1.8*)

SAA5281

NOTES

Philips Semiconductors – a worldwide company

Argentina: see South America

Australia: 34 Waterloo Road, NORTH RYDE, NSW 2113,
Tel. +61 2 9805 4455, Fax. +61 2 9805 4466

Austria: Computerstr. 6, A-1101 WIEN, P.O. Box 213,
Tel. +43 1 60 101, Fax. +43 1 60 101 1210

Belarus: Hotel Minsk Business Center, Bld. 3, r. 1211, Volodarski Str. 6,
220050 MINSK, Tel. +375 172 200 733, Fax. +375 172 200 773

Belgium: see The Netherlands

Brazil: see South America

Bulgaria: Philips Bulgaria Ltd., Energoproject, 15th floor,
51 James Bourchier Blvd., 1407 SOFIA,
Tel. +359 2 689 211, Fax. +359 2 689 102

Canada: PHILIPS SEMICONDUCTORS/COMPONENTS,
Tel. +1 800 234 7381

China/Hong Kong: 501 Hong Kong Industrial Technology Centre,
72 Tat Chee Avenue, Kowloon Tong, HONG KONG,
Tel. +852 2319 7888, Fax. +852 2319 7700

Colombia: see South America

Czech Republic: see Austria

Denmark: Prags Boulevard 80, PB 1919, DK-2300 COPENHAGEN S,
Tel. +45 32 88 2636, Fax. +45 31 57 1949

Finland: Sinikalliontie 3, FIN-02630 ESPOO,
Tel. +358 9 615800, Fax. +358 9 61580/xxx

France: 4 Rue du Port-aux-Vins, BP317, 92156 SURESNES Cedex,
Tel. +33 1 40 99 6161, Fax. +33 1 40 99 6427

Germany: Hammerbrookstraße 69, D-20097 HAMBURG,
Tel. +49 40 23 53 60, Fax. +49 40 23 536 300

Greece: No. 15, 25th March Street, GR 17778 TAVROS/ATHENS,
Tel. +30 1 4894 339/239, Fax. +30 1 4814 240

Hungary: see Austria

India: Philips INDIA Ltd, Shivsagar Estate, A Block, Dr. Annie Besant Rd.
Worli, MUMBAI 400 018, Tel. +91 22 4938 541, Fax. +91 22 4938 722

Indonesia: see Singapore

Ireland: Newstead, Clonskeagh, DUBLIN 14,
Tel. +353 1 7640 000, Fax. +353 1 7640 200

Israel: RAPAC Electronics, 7 Kehilat Saloniki St, TEL AVIV 61180,
Tel. +972 3 645 0444, Fax. +972 3 649 1007

Italy: PHILIPS SEMICONDUCTORS, Piazza IV Novembre 3,
20124 MILANO, Tel. +39 2 6752 2531, Fax. +39 2 6752 2557

Japan: Philips Bldg 13-37, Kohnan 2-chome, Minato-ku, TOKYO 108,
Tel. +81 3 3740 5130, Fax. +81 3 3740 5077

Korea: Philips House, 260-199 Itaewon-dong, Yongsan-ku, SEOUL,
Tel. +82 2 709 1412, Fax. +82 2 709 1415

Malaysia: No. 76 Jalan Universiti, 46200 PETALING JAYA, SELANGOR,
Tel. +60 3 750 5214, Fax. +60 3 757 4880

Mexico: 5900 Gateway East, Suite 200, EL PASO, TEXAS 79905,
Tel. +9-5 800 234 7381

Middle East: see Italy

Netherlands: Postbus 90050, 5600 PB EINDHOVEN, Bldg. VB,
Tel. +31 40 27 82785, Fax. +31 40 27 88399

New Zealand: 2 Wagener Place, C.P.O. Box 1041, AUCKLAND,
Tel. +64 9 849 4160, Fax. +64 9 849 7811

Norway: Box 1, Manglerud 0612, OSLO,
Tel. +47 22 74 8000, Fax. +47 22 74 8341

Philippines: Philips Semiconductors Philippines Inc.,
106 Valero St. Salcedo Village, P.O. Box 2108 MCC, MAKATI,
Metro MANILA, Tel. +63 2 816 6380, Fax. +63 2 817 3474

Poland: Ul. Lukiska 10, PL 04-123 WARSZAWA,
Tel. +48 22 612 2831, Fax. +48 22 612 2327

Portugal: see Spain

Romania: see Italy

Russia: Philips Russia, Ul. Usatcheva 35A, 119048 MOSCOW,
Tel. +7 095 247 9145, Fax. +7 095 247 9144

Singapore: Lorong 1, Toa Payoh, SINGAPORE 1231,
Tel. +65 350 2538, Fax. +65 251 6500

Slovakia: see Austria

Slovenia: see Italy

South Africa: S.A. PHILIPS Pty Ltd., 195-215 Main Road Martindale,
2092 JOHANNESBURG, P.O. Box 7430 Johannesburg 2000,
Tel. +27 11 470 5911, Fax. +27 11 470 5494

South America: Rua do Rocio 220, 5th floor, Suite 51,
04552-903 São Paulo, SÃO PAULO - SP, Brazil,
Tel. +55 11 821 2333, Fax. +55 11 829 1849

Spain: Balmes 22, 08007 BARCELONA,
Tel. +34 3 301 6312, Fax. +34 3 301 4107

Sweden: Kottbygatan 7, Akalla, S-16485 STOCKHOLM,
Tel. +46 8 632 2000, Fax. +46 8 632 2745

Switzerland: Allmendstrasse 140, CH-8027 ZÜRICH,
Tel. +41 1 488 2686, Fax. +41 1 481 7730

Taiwan: PHILIPS TAIWAN Ltd., 23-30F, 66,
Chung Hsiao West Road, Sec. 1, P.O. Box 22978,
TAIPEI 100, Tel. +886 2 382 4443, Fax. +886 2 382 4444

Thailand: PHILIPS ELECTRONICS (THAILAND) Ltd.,
209/2 Sanpavuth-Bangna Road Prakanong, BANGKOK 10260,
Tel. +66 2 745 4090, Fax. +66 2 398 0793

Turkey: Talatpasa Cad. No. 5, 80640 GÜLTEPE/ISTANBUL,
Tel. +90 212 279 2770, Fax. +90 212 282 6707

Ukraine: PHILIPS UKRAINE, 4 Patrice Lumumba str., Building B, Floor 7,
252042 KIEV, Tel. +380 44 264 2776, Fax. +380 44 268 0461

United Kingdom: Philips Semiconductors Ltd., 276 Bath Road, Hayes,
MIDDLESEX UB3 5BX, Tel. +44 181 730 5000, Fax. +44 181 754 8421

United States: 811 East Arques Avenue, SUNNYVALE, CA 94088-3409,
Tel. +1 800 234 7381

Uruguay: see South America

Vietnam: see Singapore

Yugoslavia: PHILIPS, Trg N. Pasica 5/v, 11000 BEOGRAD,
Tel. +381 11 625 344, Fax. +381 11 635 777

For all other countries apply to: Philips Semiconductors, Marketing & Sales Communications,
Building BE-p, P.O. Box 218, 5600 MD EINDHOVEN, The Netherlands, Fax. +31 40 27 24825

Internet: <http://www.semiconductors.philips.com>

© Philips Electronics N.V. 1996

SCA52

All rights are reserved. Reproduction in whole or in part is prohibited without the prior written consent of the copyright owner.

The information presented in this document does not form part of any quotation or contract, is believed to be accurate and reliable and may be changed without notice. No liability will be accepted by the publisher for any consequence of its use. Publication thereof does not convey nor imply any license under patent- or other industrial or intellectual property rights.

Printed in The Netherlands

537021/1200/02/pp48

Date of release: 1996 Nov 04

Document order number: 9397 750 01461

Let's make things better.

**Philips
Semiconductors**



PHILIPS