

High frequency rectifier schottky barrier diode

RB051L-40

New

●Applications

High frequency rectification
For switching power supply

●Features

- 1) Compact power mold type. (PMDS)
- 2) Extreme low forward voltage.
(typical capability of 0.29V at 1A)
- 3) $V_{RM}=40V$ guaranteed.

●Construction

Silicon epitaxial planar

●Absolute maximum ratings ($T_a = 25^\circ\text{C}$)

Parameter	Symbol	Limits	Unit
Peak reverse voltage	V_{RM}	40	V
DC reverse voltage	V_R	20	V
Mean rectifying current *	I_o	3.0	A
Peak forward surge current (60Hz · 1ms)	I_{FSM}	70	A
Junction temperature	T_j	125	$^\circ\text{C}$
Storage temperature	T_{stg}	-40~+125	$^\circ\text{C}$

* TL 90°C Max. 180° half sine wave when mounted on an alumina substrate
(82 x 30 x 1.0 mm)

●Electrical characteristics ($T_a = 25^\circ\text{C}$)

Parameter	Symbol	Typ.	Max.	Unit	Conditions
Forward voltage	V_{F1}	0.29	0.35	V	$I_F=1.0A$
	V_{F2}	0.35	0.45	V	$I_F=3.0A$
Reverse current	I_{R1}	0.09	1.0	mA	$V_R=20V$
	I_{R2}	60	150	μA	$V_R=15V$

●External dimensions (Units: mm)

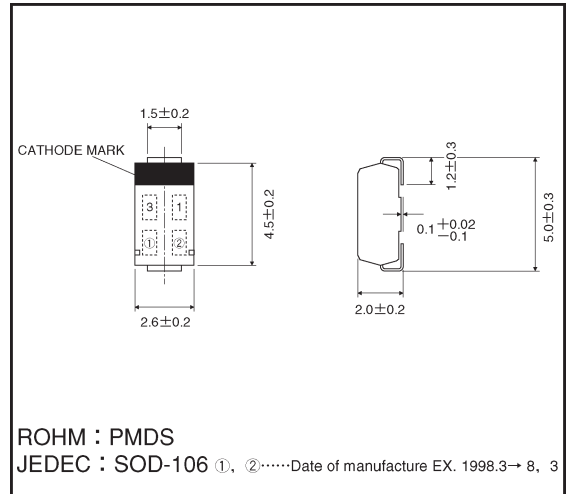

●Electrical characteristic curves (Ta = 25°C unless specified otherwise)

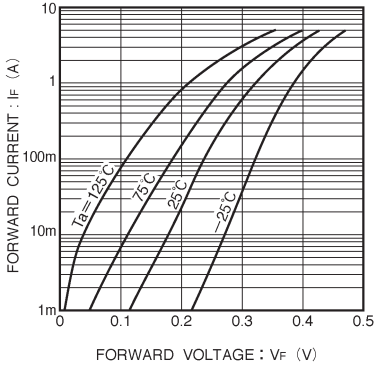

Fig. 1 Forward characteristics

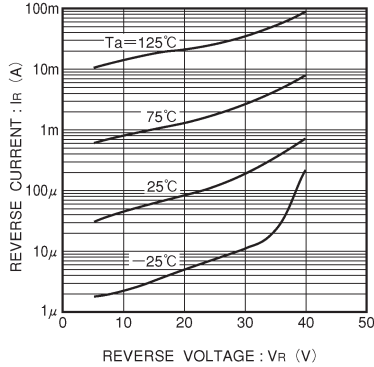

Fig. 2 Reverse characteristics

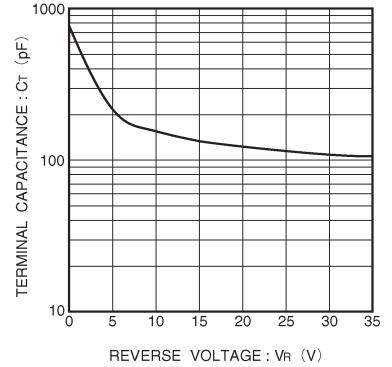

Fig. 3 Capacitance between terminals characteristics

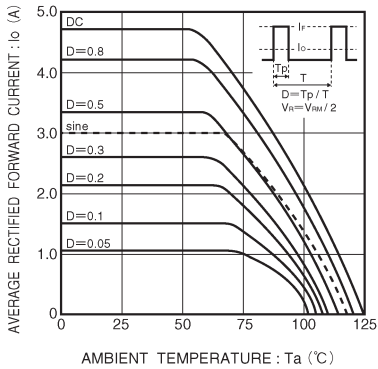

Fig. 4 Derating curve (Io - Ta)

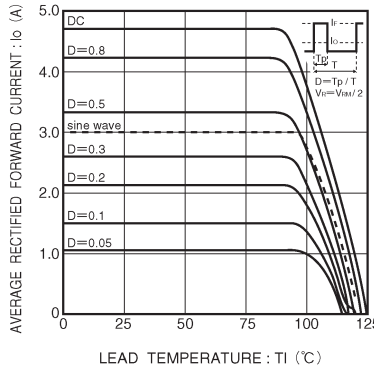

Fig. 5 Derating curve (Io - TI)
(When mounted on alumina PCBs)

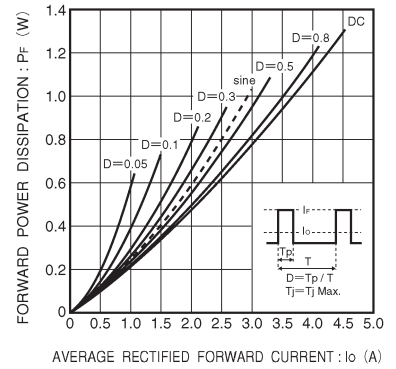

Fig. 6 Forward power dissipation characteristics

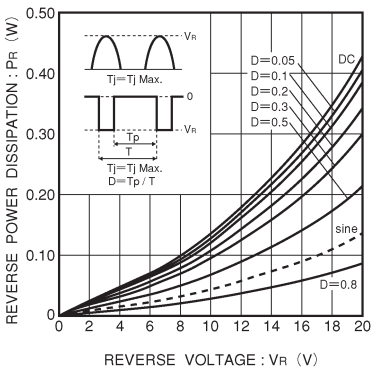

Fig. 7 Reverse power dissipation characteristics

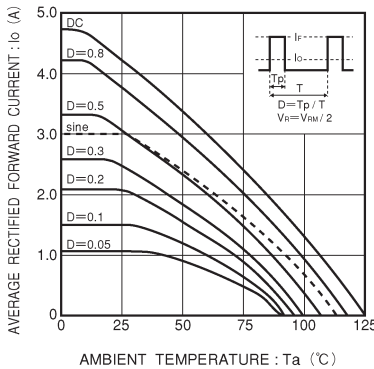

Fig. 8 Derating curve
(when mounted on a glass epoxy PCBs board)