

# Multi-layer ceramic chip capacitors

## MCH31 (3216 (1206) size, chip capacitor)

### ●Features

- 1) Small size (3.2 x 1.6 x 0.85 mm) makes it perfect for lightweight portable devices.
- 2) Comes packed either in taping to enable automatic mounting.
- 3) Precise uniformity of shape and dimensions facilitates highly efficient automatic mounting.
- 4) Solder-coated terminals offer superior solderability and resistance to soldering heat.

### Structure

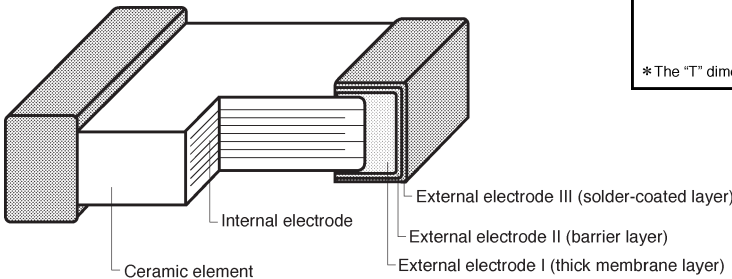

### ●External dimensions (Units: mm)

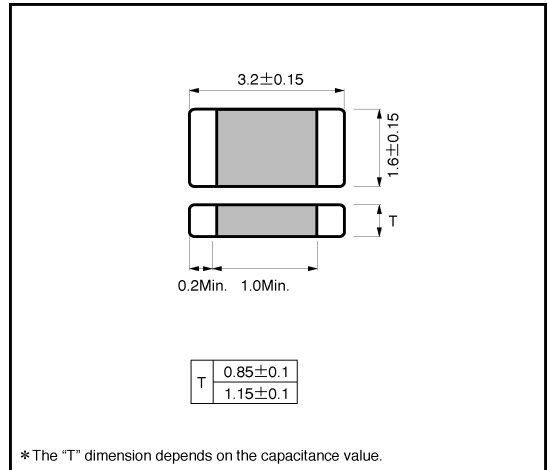

### ●Product Designation

Code	Product thickness	Packaging specifications	Reel	Basic ordering unit (pcs.)
K	0.85mm	Paper tape (width 8mm, pitch 4mm)	φ180mm (7in.)	4,000
L	0.85mm	Paper tape (width 8mm, pitch 4mm)	φ330mm (13in.)	16,000
P	1.15mm	Plastic tape (width 8mm, pitch 4mm)	φ180mm (7in.)	3,000
Q	1.15mm	Plastic tape (width 8mm, pitch 4mm)	φ330mm (13in.)	12,000

Reel (φ180, φ330mm) : compatible EIAJ ETX-7001

#### Packaging style

Part No.











Rated voltage	
Code	Voltage
2	25V
3	16V
5	50V

Capacitance-temperature characteristics				Nominal capacitance	Capacitance tolerance	
Code	EIA code	Operating temperature range (°C)	Temp. coefficient or percent change		Code	tolerance
A	C0G	-55 to +125	0±30ppm / °C	3-digit designation according to IEC	J	±5%
C	X7R	-55 to +125 (-25 to +85)	±15% (±10%)		K	±10%
F	Y5V	-30 to +85	+22%, -82%		Z	+80%, -20%

















\*The design and specifications are subject to change without prior notice. Before ordering or using, please check the latest technical specification.

●Capacitance range

For thermal compensation

Part number		MCH31
Capacitance (pF)	Temperature characteristics	A (COG)
	Rated voltage (V)	50
Tolerance		
270	J (±5%)	
300		
330		
360		
390		
430		
470		
510		
560		
620		
680		
750		
820		
910		
1,000		
1,100		
1,200		
1,300		
1,500		
1,600		
1,800		
2,000		
2,200		
2,400		
2,700		
3,000		
3,300		
3,600		
3,900		
4,300		
4,700		
5,100		
5,600		
6,200		
6,800		
7,500		
8,200		
9,100		
10,000		
11,000		
12,000		
13,000		

High dielectric constant

Part number		MCH31					
Capacitance (pF)	Temperature characteristics	C (X7R)			F (Y5V)		
	Rated voltage (V)	50	25	16	50	25	16
Tolerance		K (±10%)			Z (+80, -20%)		
220							
270							
330							
390							
470							
560							
680							
820							
1,000							
1,200							
1,500							
1,800							
2,200							
2,700							
3,300							
3,900							
4,700							
5,600							
6,800							
8,200							
10,000 (0.01 μF)							
12,000							
15,000							
18,000							
22,000							
27,000							
33,000							
39,000							
47,000							
56,000							
68,000							
82,000							
100,000 (0.1 μF)							
120,000							
150,000							
180,000							
220,000							
270,000							
330,000							
390,000							
470,000							
560,000							
680,000							
1,000,000 (1 μF)							
1,200,000							
1,500,000							
1,800,000							
2,200,000							



 

Product thickness (mm) 0.85±0.1 1.15±0.1

\*The design and specifications are subject to change without prior notice. Before ordering or using, please check the latest technical specification.



## ●Characteristics

Class 1 (For Thermal compensation)

Temperature characteristics		A (C0G)	Test methods / conditions (based on JIS C 5102)
Item			
Operating temperature		-55°C ~ +125°C	—
Nominal capacitance (C)		Must be within the specified tolerance range.	Based on paragraph 7.8 and paragraph 9 Measured at room temperature and standard humidity. Over 1000pF Measurement frequency : $1 \pm 0.1$ kHz Measurement voltage : $1 \pm 0.1$ Vrms.
Tan $\delta$		0.1% or less	
Insulation resistance (IR)		10,000 M $\Omega$ or larger, or 500 $\Omega$ F or larger, whichever is smaller	Based on paragraph 7.6 is applied for 60 $\pm$ 5s Measurement is made after rated voltage.
Withstanding voltage		The insulation must not be damaged.	Based on paragraph 7.1 for 1 to 5s then measure Apply 300% of the rated voltage.
Temperature characteristics		Within 0 $\pm$ 30ppm / °C	The temperature coefficients in table 12, paragraph 7.12 are calculated at 20°C and high temperature.
Terminal adherence		No detachment or signs of detachment.	Based on paragraph 8. 11. 2 Apply 5N (0.51 kg-f) for 10 $\pm$ 1s in the direction indicated by the arrow. 
Resistance to vibration	Appearance	There must be no mechanical damage.	Chip is mounted to a board in the manner shown on the right, subjected to vibration (type A in paragraph 8.2), and measured 24 $\pm$ 2 hrs. later. 
	Rate of capacitance change	Must be within initial tolerance.	
	Tan $\delta$	Must satisfy initial specified value.	
Solderability		At least 3 / 4 of the surface of the two terminals must be covered with new solder.	Based on paragraph 8.13 Soldering temperature : 235 $\pm$ 5°C Soldering time : 2 $\pm$ 0.5s
Resistance to soldering heat	Appearance	There must be no mechanical damage.	Based on paragraph 8. 14 Soldering temperature : 260 $\pm$ 5°C Soldering time : 5 $\pm$ 0.5s Preheating : 150 $\pm$ 10°C for 1 to 2 min.
	Rate of capacitance change	$\pm 2.5\%$ or less, or $\pm 0.25$ pF or less, whichever is larger.	
	Tan $\delta$	Must satisfy initial specified value.	
	Insulation resistance	10,000 M $\Omega$ or larger, or 500 $\Omega$ F or larger, whichever is smaller	
	Withstanding voltage	The insulation must not be damaged.	
Temperature cycling	Appearance	There must be no mechanical damage.	Based on paragraph 9.3, Number of cycles : 10 Capacitance measured after 24 $\pm$ 2 hrs.
	Rate of capacitance change	$\pm 2.5\%$ or less, or $\pm 0.25$ pF or less, whichever is larger.	
	Tan $\delta$	Must satisfy initial specified value.	
	Insulation resistance	10,000 M $\Omega$ or larger, or 500 $\Omega$ F or larger, whichever is smaller	
Humidity load test	Appearance	There must be no mechanical damage.	Based on paragraph 9.9, Test temperature : 40 $\pm$ 2°C Relative humidity : 90% to 95% Applied voltage : rated voltage Test time : 500 to 524 hrs. Capacitance measured after 24 $\pm$ 2 hrs.
	Rate of capacitance change	$\pm 7.5\%$ or less, or $\pm 0.75$ pF or less, whichever is larger.	
	Tan $\delta$	0.5% or less	
	Insulation resistance	500 M $\Omega$ or larger, or 25 $\Omega$ F or larger, whichever is smaller	
High-temperature load test	Appearance	There must be no mechanical damage.	Based on paragraph 9.10, Test temperature : Max. operating temp. Applied voltage : rated voltage x 200% Test time : 1,000 to 1,048 hrs. Capacitance measured after 24 $\pm$ 2 hrs.
	Rate of capacitance change	$\pm 3.0\%$ or less, or $\pm 0.3$ pF or less, whichever is larger.	
	Tan $\delta$	0.3% or less	
	Insulation resistance	1,000 M $\Omega$ or larger, or 50 $\Omega$ F or larger, whichever is smaller	

\*The design and specifications are subject to change without prior notice. Before ordering or using, please check the latest technical specification.

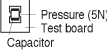
Class 2 (High dielectric constant)

Temperature characteristics		C (X7R)	F (Y5V)	Test methods / conditions (based on JIS C 5102)
Item				
Operating temperature		-55°C ~ +125°C	-30°C ~ +85°C	————
Nominal capacitance (C)		Must be within the specified tolerance range.		Based on paragraph 7.8 Measured at room temperature and standard humidity. Measurement frequency : 1 ±0.1 kHz Measurement voltage : 1 ±0.2 Vrms.
Tan δ		2.5% or less (when rated voltage is 16V: 3.5% or less)	5.0% or less (when rated voltage is 16V: 7.5% or less)	
Insulation resistance (IR)		10,000 MΩ or larger, or 500 ΩF or larger, whichever is smaller		Based on paragraph 7.6 is applied for 60±5s Measurement is made after rated voltage.
Withstanding voltage		The insulation must not be damaged.		Based on paragraph 7.1 for 1 to 5s then measure Apply 250% of the rated voltage.
Temperature characteristics		Within ±15%	±22, -82%	The temperature coefficients in paragraph 7.12, table 8, condition B, are based on measurements carried out at 20°C, with no voltage applied.
Terminal adherence		No detachment or signs of detachment.		Based on paragraph 8. 11. 2 Apply 5N (0.51 kg·f) for 10±1s in the direction indicated by the arrow. 
Resistance to vibration	Appearance	There must be no mechanical damage.		Chip is mounted to a board in the manner shown on the right, subjected to vibration (type A in paragraph 8.2), and measured 48±4 hrs. later. 
	Rate of capacitance change	Must be within initial tolerance.		
	Tan δ	Must satisfy initial specified value.		
Solderability		At least 3 / 4 of the surface of the two terminals must be covered with new solder.		Based on paragraph 8.13 Soldering temperature : 235 ±5°C Soldering time : 2±0.5s
Resistance to soldering heat	Appearance	There must be no mechanical damage.		Based on paragraph 8. 14 Soldering temperature : 260±5°C Soldering time : 5±0.5s Preheating : 150±10°C for 1 to 2 min.
	Rate of capacitance change	Within ±5.0%	Within ±20.0%	
	Tan δ	Must satisfy initial specified value.		
	Insulation resistance	10,000 MΩ or larger, or 500 ΩF or larger, whichever is smaller		
	Withstanding voltage	The insulation must not be damaged.		
Temperature cycling	Appearance	There must be no mechanical damage.		Based on paragraph 9.3, Number of cycles : 10 Capacitance measured after 48 ±4 hrs.
	Rate of capacitance change	Within ±7.5%	Within ±20.0%	
	Tan δ	Must satisfy initial specified value.		
	Insulation resistance	10,000 MΩ or larger, or 500 ΩF or larger, whichever is smaller		
Humidity load test	Appearance	There must be no mechanical damage.		Based on paragraph 9.9, Test temperature : 40 ±2°C Relative humidity : 90% to 95% Applied voltage : rated voltage Test time : 500 to 524 hrs. Capacitance measured after 48 ±4 hrs.
	Rate of capacitance change	Within ±12.5%	Within ±30.0%	
	Tan δ	5.0% or less	7.5% or less (when rated voltage is 16V: 10.0%)	
	Insulation resistance	500 MΩ or larger, or 25 ΩF or larger, whichever is smaller		
High-temperature load test	Appearance	There must be no mechanical damage.		Based on paragraph 9.10, Test temperature : Max. operating temp. Applied voltage : rated voltage x 200% Test time : 1,000 to 1,048 hrs. Capacitance measured after 48 ±4 hrs.
	Rate of capacitance change	Within ±10.0%	Within ±30.0%	
	Tan δ	5.0% or less	7.5% or less (when rated voltage is 16V: 10.0%)	
	Insulation resistance	1,000MΩ or larger, or 500 ΩF or larger, whichever is smaller		

\*The design and specifications are subject to change without prior notice. Before ordering or using, please check the latest technical specification.

●Packaging specifications

(Units: mm)

Taping		Reel													
		<p>φ 180mm plastic reel</p>													
<table border="1"> <thead> <tr> <th>Style</th> <th>Symbol</th> <th>A</th> <th>B</th> </tr> </thead> <tbody> <tr> <td>Paper taping</td> <td></td> <td>2.0±0.1</td> <td>3.5±0.1</td> </tr> <tr> <td>Plastic taping</td> <td></td> <td>1.9±0.1</td> <td>3.5±0.1</td> </tr> </tbody> </table>		Style	Symbol	A	B	Paper taping		2.0±0.1	3.5±0.1	Plastic taping		1.9±0.1	3.5±0.1	<p>φ 330mm plastic reel</p> <p>EIAJ ETX-7001 compliant</p>	
Style	Symbol	A	B												
Paper taping		2.0±0.1	3.5±0.1												
Plastic taping		1.9±0.1	3.5±0.1												

\*The design and specifications are subject to change without prior notice. Before ordering or using, please check the latest technical specification.

●Electrical characteristics

■A (C0G) Characteristics

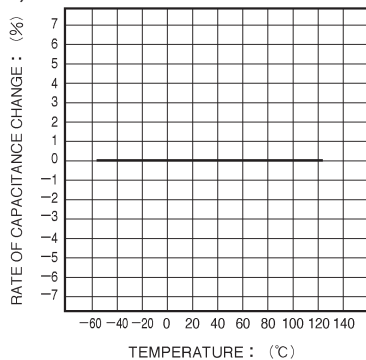

Fig.1 Capacitance - temperature characteristics

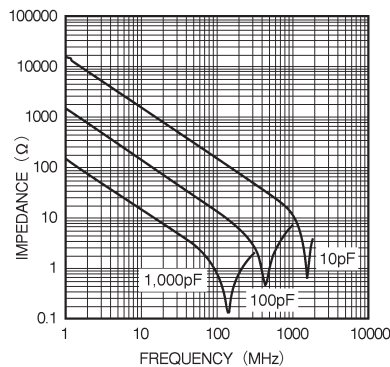

Fig.2 Impedance - frequency characteristics

■C (X7R) Characteristics

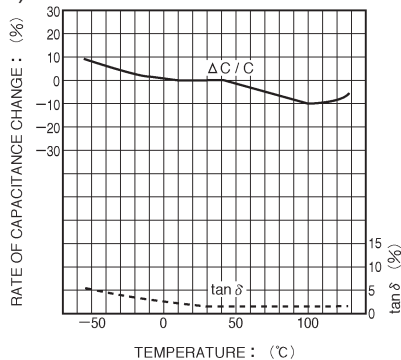

Fig.3 Capacitance - temperature characteristics

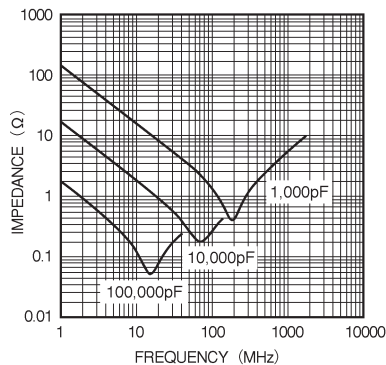

Fig.4 Impedance - frequency characteristics

■F (Y5V) Characteristics

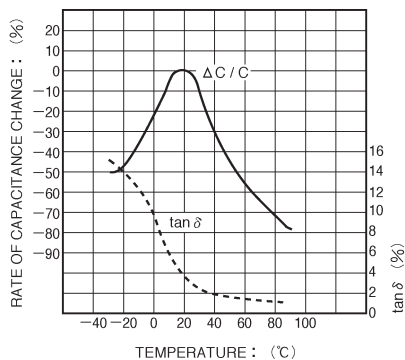

Fig.5 Capacitance - temperature characteristics

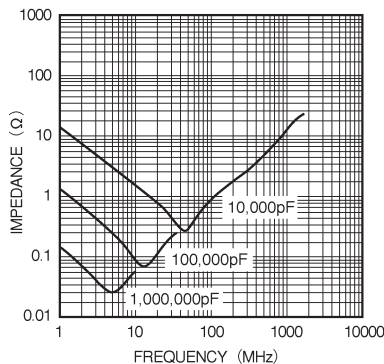

Fig.6 Impedance - frequency characteristics

\*The design and specifications are subject to change without prior notice. Before ordering or using, please check the latest technical specification.

■ Temperature cycling test

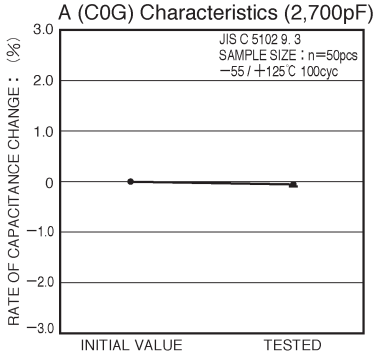

Fig.7 Rate of capacitance change

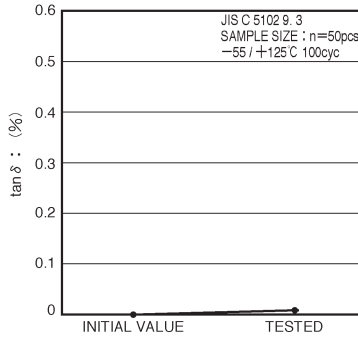

Fig.8 Tan  $\delta$

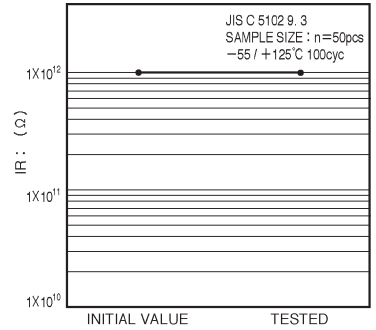

Fig.9 Insulation resistance

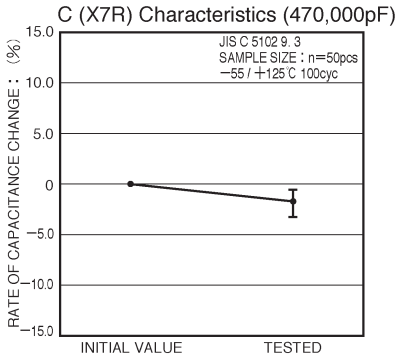

Fig.10 Rate of capacitance change

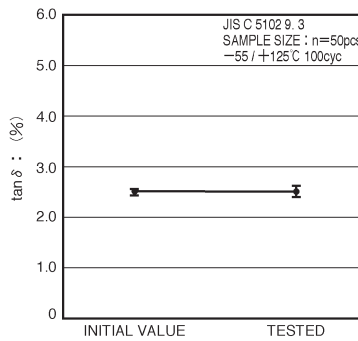

Fig.11 Tan  $\delta$

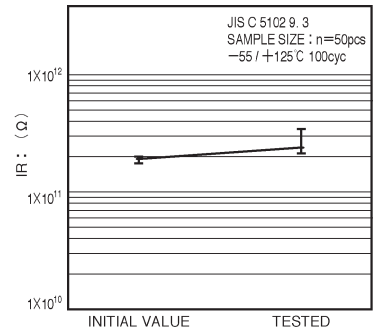

Fig.12 Insulation resistance

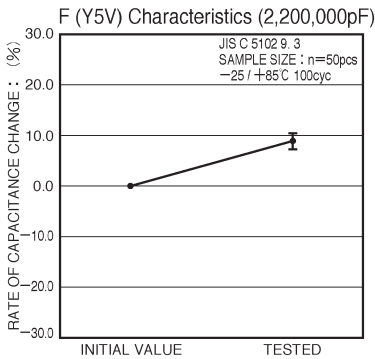

Fig.13 Rate of capacitance change

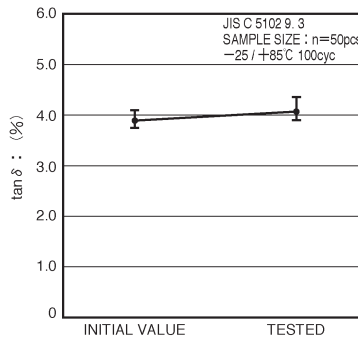

Fig.14 Tan  $\delta$

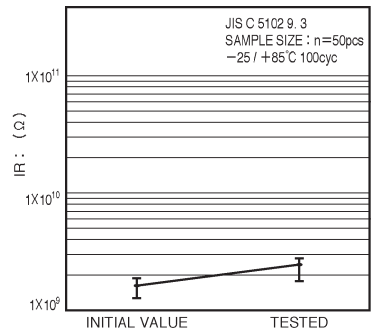

Fig.15 Insulation resistance

\*The design and specifications are subject to change without prior notice. Before ordering or using, please check the latest technical specification.

■ High-temperature load test

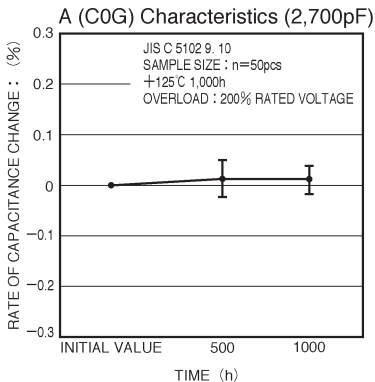

Fig.16 Rate of capacitance change

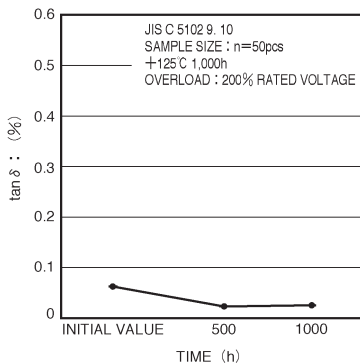

Fig.17 Tan  $\delta$

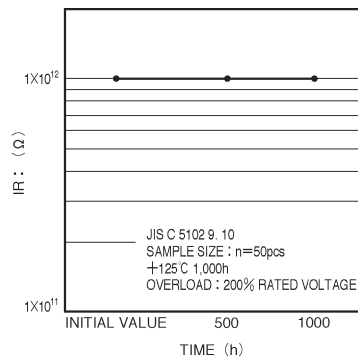

Fig.18 Insulation resistance

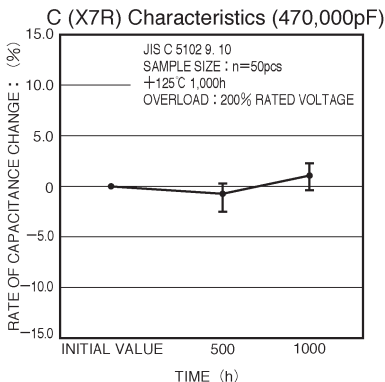

Fig.19 Rate of capacitance change

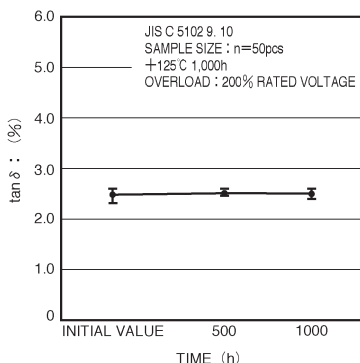

Fig.20 Tan  $\delta$

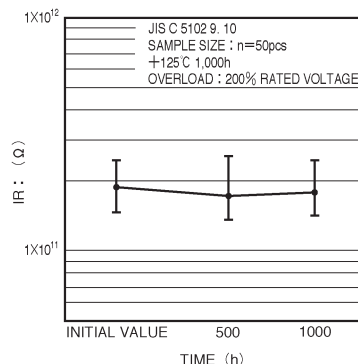

Fig.21 Insulation resistance

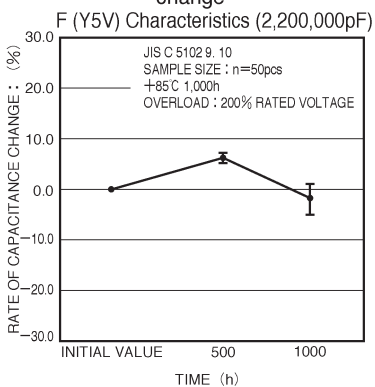

Fig.22 Rate of capacitance change

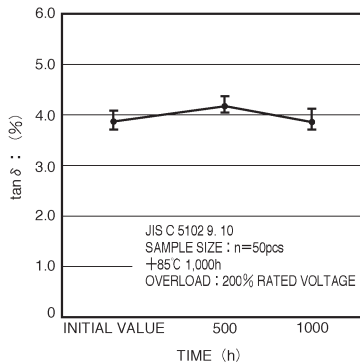

Fig.23 Tan  $\delta$

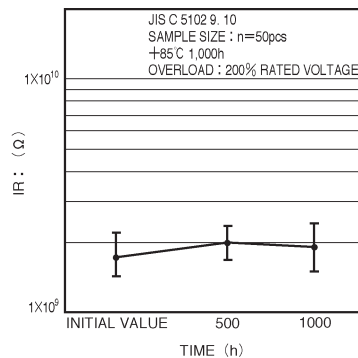

Fig.24 Insulation resistance

\*The design and specifications are subject to change without prior notice. Before ordering or using, please check the latest technical specification.



■ Humidity load test

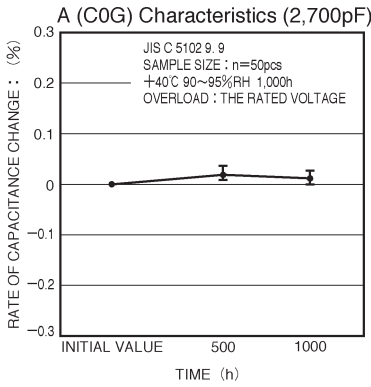

Fig.25 Rate of capacitance change

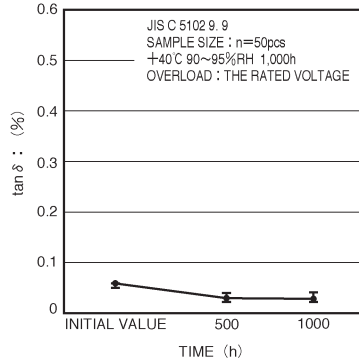

Fig.26 Tan  $\delta$

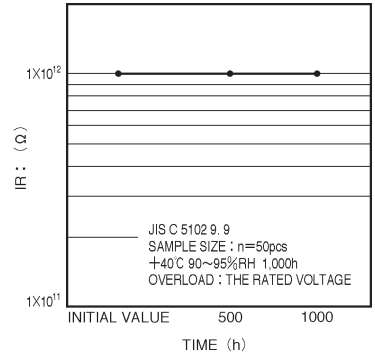

Fig.27 Insulation resistance

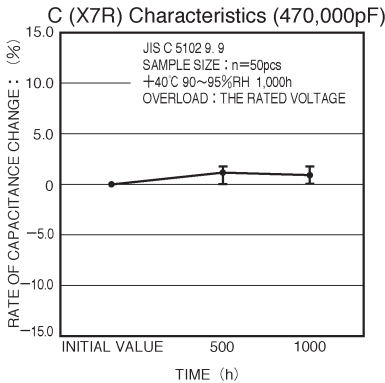

Fig.28 Rate of capacitance change

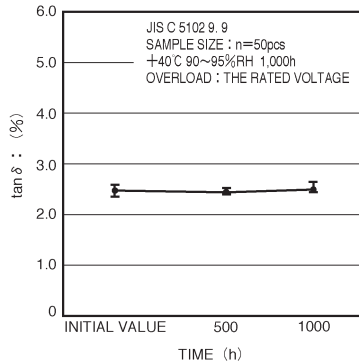

Fig.29 Tan  $\delta$

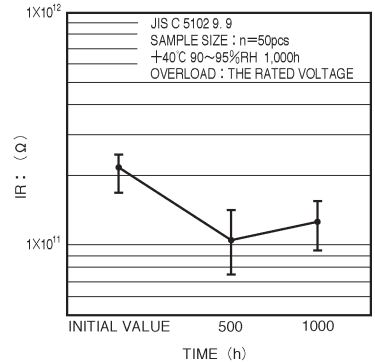

Fig.30 Insulation resistance

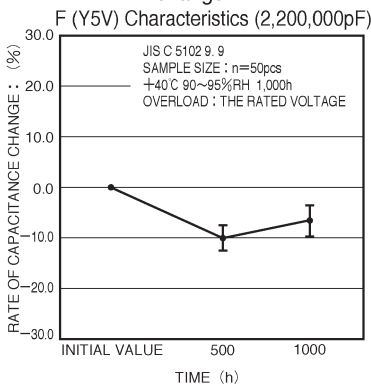

Fig.31 Rate of capacitance change

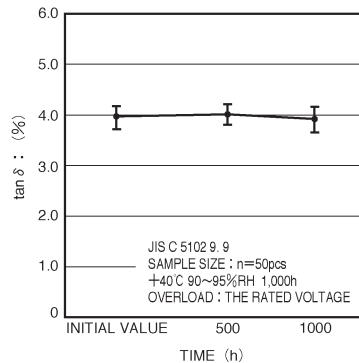

Fig.32 Tan  $\delta$

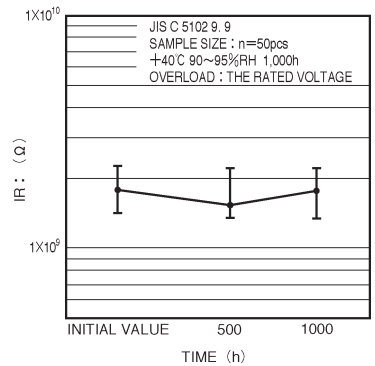

Fig.33 Insulation resistance

\*The design and specifications are subject to change without prior notice. Before ordering or using, please check the latest technical specification.