

FOUR UA741 QUAD BIPOLAR OPERATIONAL AMPLIFIERS

- LOW SUPPLY CURRENT : 0.53mA/AMPLIFIER
- CLASS AB OUTPUT STAGE : NO CROSS-OVER DISTORTION
- PIN COMPATIBLE WITH LM124
- LOW INPUT OFFSET VOLTAGE : 1mV
- LOW INPUT OFFSET CURRENT : 2nA
- LOW INPUT BIAS CURRENT : 30nA
- GAIN BANDWIDTH PRODUCT : 1.3MHz
- HIGH DEGREE OF ISOLATION BETWEEN AMPLIFIERS : 120dB
- OVERLOAD PROTECTION FOR INPUTS AND OUTPUTS

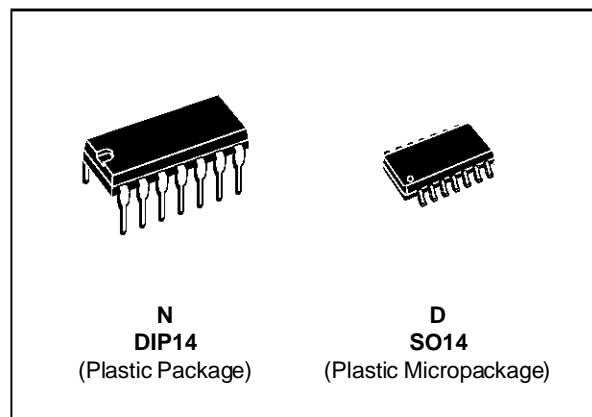

ORDER CODES

| Part Number | Temperature Range | Package | |
|-------------|-------------------|---------|---|
| | | N | D |
| LM148 | -55°C, +125°C | • | • |
| LM248 | -40°C, +105°C | • | • |
| LM348 | 0°C, +70°C | • | • |

Example : LM348D

DESCRIPTION

The LM148 consists of four independent, high gain internally compensated, low power operational amplifiers which have been designed to provide functional characteristics identical to those of the familiar UA741 operational amplifier. In addition the total supply current for all four amplifiers is comparable to the supply current of a single UA741 type op amp. Other features include input offset current and input bias current which are much less than those of a standard UA741. Also, excellent isolation between amplifiers has been achieved by independently biasing each amplifier and using layout techniques which minimize thermal coupling.

The LM148 can be used anywhere multiple UA741 type amplifiers are being used and in applications where amplifier matching or high packing density is required.

PIN CONNECTIONS (top view)

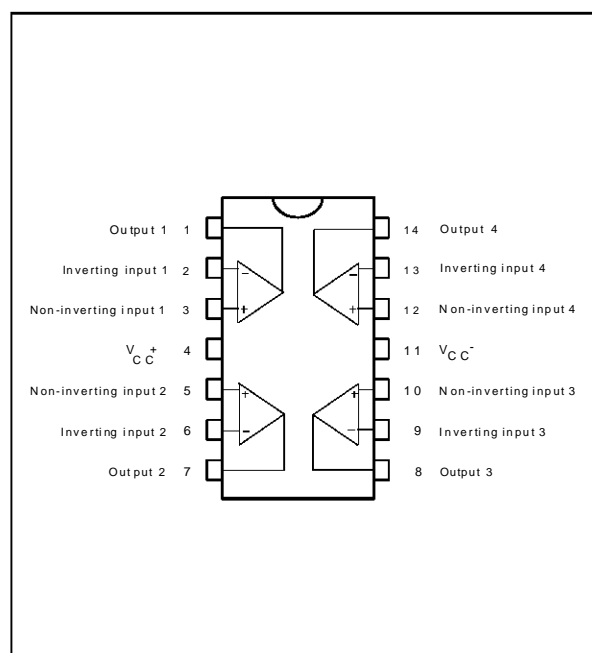

SCHEMATIC DIAGRAM

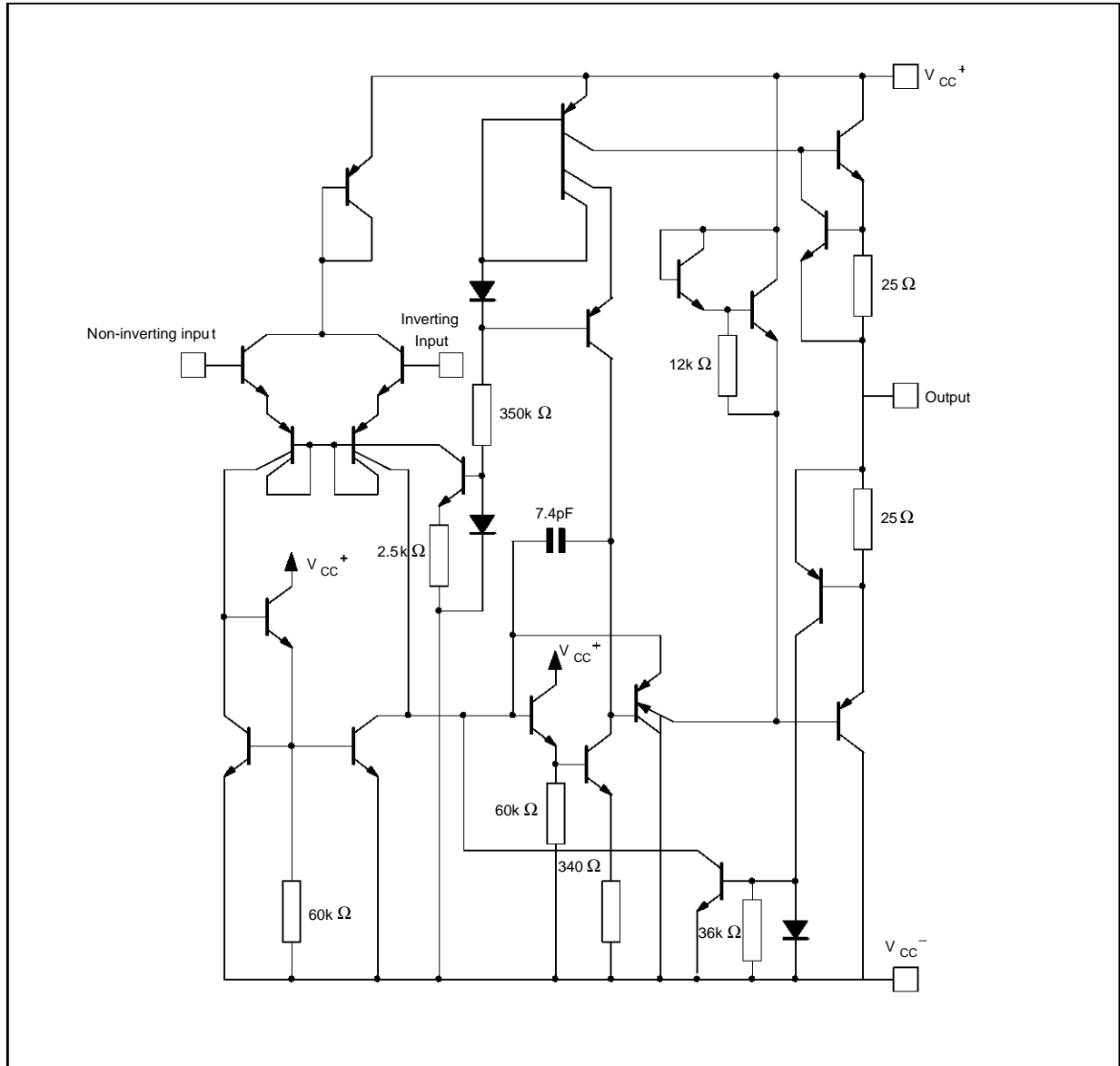

ABSOLUTE MAXIMUM RATINGS

| Symbol | Parameter | LM148 | LM248 | LM348 | Unit |
|-------------------|----------------------------------------|-----------|-----------|-----------|------|
| V _{CC} | Supply Voltage | ± 22 | ± 22 | ± 22 | V |
| V _{id} | Differential Input Voltage | ±44 | ± 44 | ± 44 | V |
| V _i | Input Voltage (note 1) | ± 22 | ± 22 | ± 22 | V |
| P _{tot} | Power Dissipation | 500 | 500 | 500 | mW |
| | Output Short-circuit Duration (note 2) | Infinite | | | |
| T _{oper} | Operating Free-air Temperature Range | -55, +125 | -40, +105 | 0, +70 | °C |
| T _{stg} | Storage Temperature Range | -65, +150 | -65, +150 | -65, +150 | °C |

Notes : 1. For supply voltage less than maximum value, the absolute maximum input voltage is equal to the supply voltage.
 2. Any of the amplifier outputs can be shorted to ground indefinitely ; however, more than one should not be simultaneously shorted as the maximum junction temperature will be exceeded.

ELECTRICAL CHARACTERISTICS

V_{CC} = ±15V, T_{amb} = 25°C (unless otherwise specified)

| Symbol | Parameter | LM148 - LM248 - LM348 | | | Unit |
|----------------------------------|---------------------------------------------------------------------------------------------------------------------------------------------------------------------------------------------------------------|-----------------------|----------|------------|------------------------|
| | | Min. | Typ. | Max. | |
| V _{io} | Input Offset Voltage (R _S ≤ 10kΩ) T _{amb} = 25°C T _{min.} ≤ T _{amb} ≤ T _{max.} | | 1 | 5 6 | mV |
| I _{io} | Input Offset Current T _{amb} = 25°C T _{min.} ≤ T _{amb} ≤ T _{max.} | | 2 | 25 75 | nA |
| I _{ib} | Input Bias Current T _{amb} = 25°C T _{min.} ≤ T _{amb} ≤ T _{max.} | | 30 | 100 300 | nA |
| A _{vd} | Large Signal Voltage Gain (V _o = ±10V, R _L = 2kΩ) T _{amb} = 25°C T _{min.} ≤ T _{amb} ≤ T _{max.} | 50 25 | 160 | | V/mV |
| SVR | Supply Voltage Rejection Ratio (R _S ≤ 10kΩ) T _{amb} = 25°C T _{min.} ≤ T _{amb} ≤ T _{max.} | 77 77 | 100 | | dB |
| I _{cc} | Supply Current, all Amp, no Load T _{amb} = 25°C T _{min.} ≤ T _{amb} ≤ T _{max.} | | 2.1 | 3.6 4.8 | mA |
| V _{icm} | Input Common Mode Voltage Range T _{amb} = 25°C T _{min.} ≤ T _{amb} ≤ T _{max.} | ±12 ±12 | | | V |
| CMR | Common Mode Rejection Ratio (R _S ≤ 10kΩ) T _{amb} = 25°C T _{min.} ≤ T _{amb} ≤ T _{max.} | 70 70 | 110 | | dB |
| I _{os} | Output Short-circuit Current T _{amb} = 25°C | 10 | 25 | 35 | mA |
| ± V _{opp} | Output Voltage Swing T _{amb} = 25°C T _{min.} ≤ T _{amb} ≤ T _{max.} R _L = 10kΩ R _L = 2kΩ R _L = 10kΩ R _L = 2kΩ | 12 10 12 10 | 13 12 | | V |
| SR | Slew Rate (V _I = ±10V, R _L = 10kΩ, C _L = 100pF, unity Gain) | 0.25 | 0.5 | | V/μs |
| t _r | Rise Time (V _I = ±10V, R _L = 10kΩ, C _L = 100pF, unity Gain) | | 0.3 | | μs |
| K _{Ov} | Overshoot (V _I = ±10V, R _L = 10kΩ, C _L = 100pF, unity Gain) | | 5 | | % |
| R _I | Input Resistance | 0.8 | 2.5 | | MΩ |
| GBP | Gain Bandwidth Product (V _I = 10 mV, R _L = 10kΩ, C _L = 100pF, f = 100kHz) | 0.7 | 1.3 | | MHz |
| THD | Total Harmonic Distortion (f = 1kHz, A _v = 20dB, R _L = 10kΩ, C _L = 100pF, V _o = 2V _{pp}) | | 0.08 | | % |
| e _n | Equivalent Input Noise Voltage (f = 1kHz, R _S = 100Ω) | | 40 | | $\frac{nV}{\sqrt{Hz}}$ |
| V _{o1} /V _{o2} | Channel Separation | | 120 | | dB |

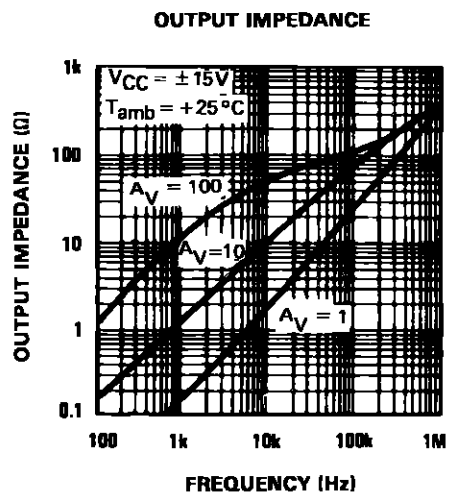
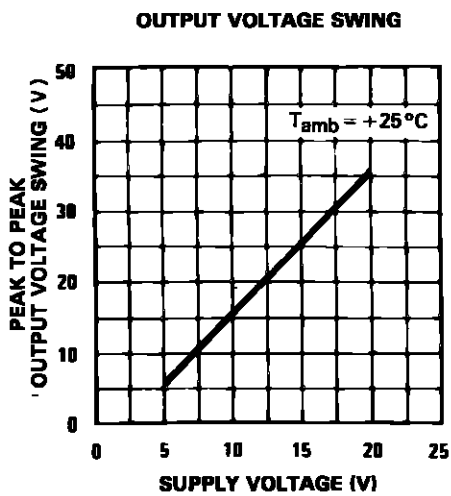
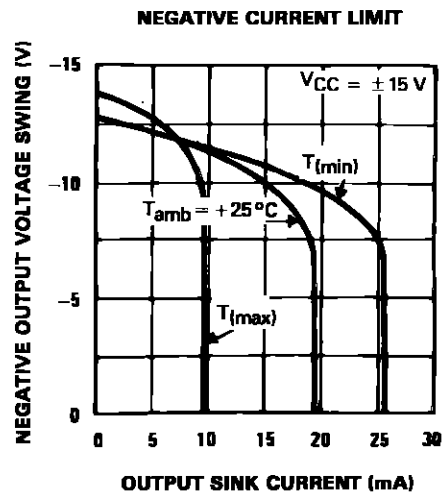
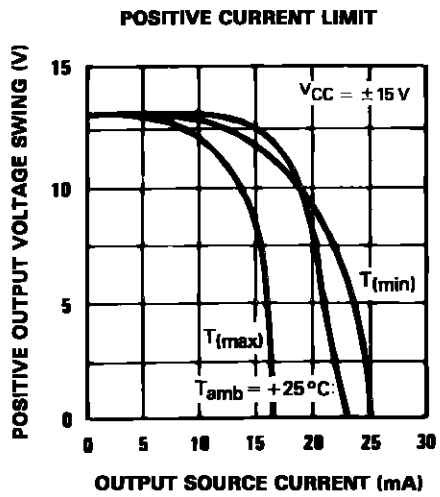
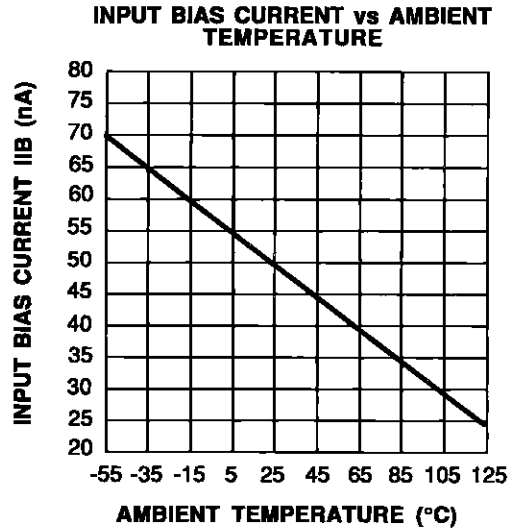
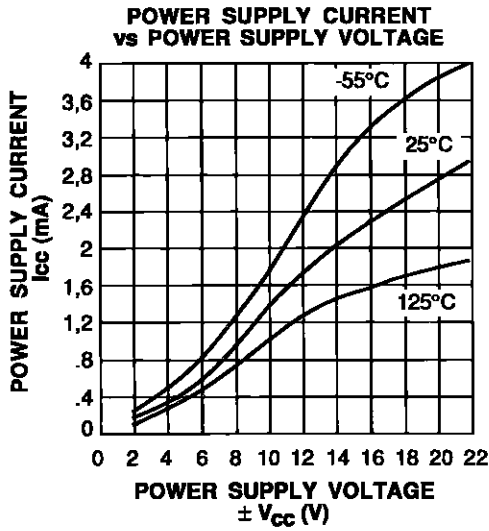

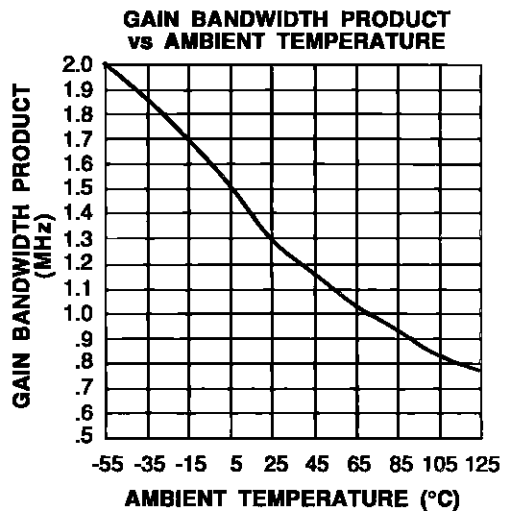
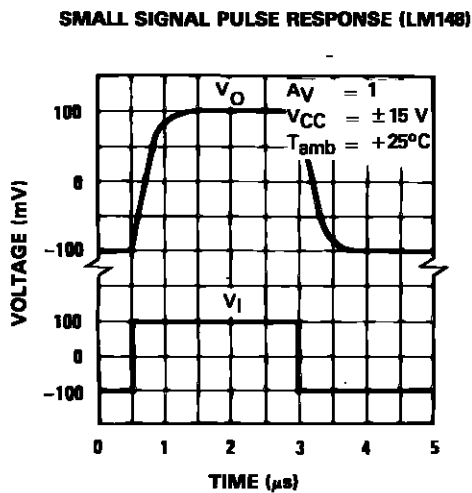
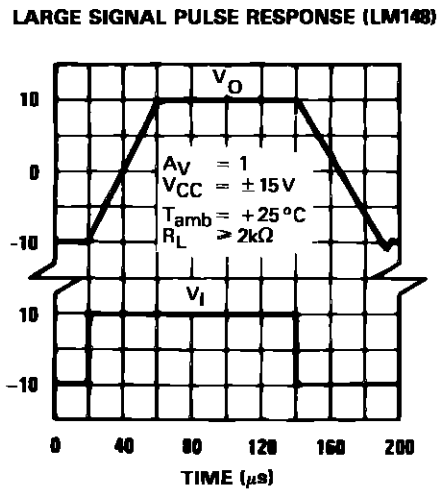
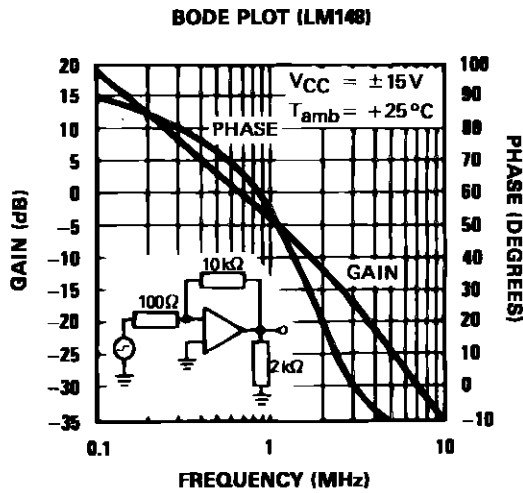
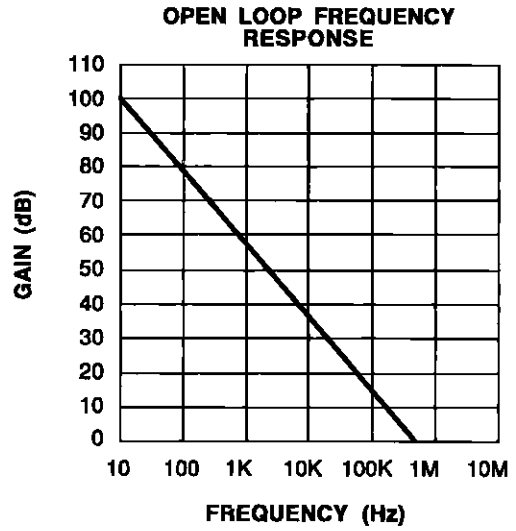
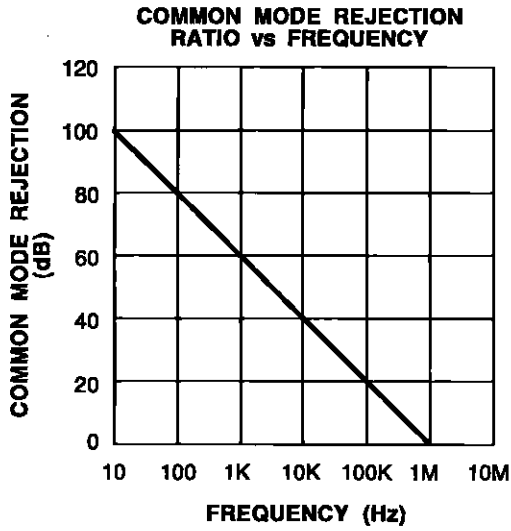

INVERTING LARGE SIGNAL PULSE RESPONSE (LM148)

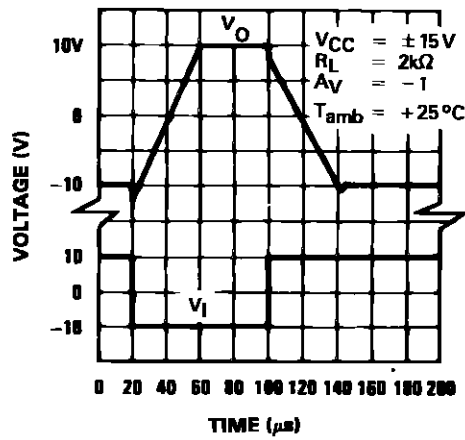

SLEW-RATE vs TEMPERATURE

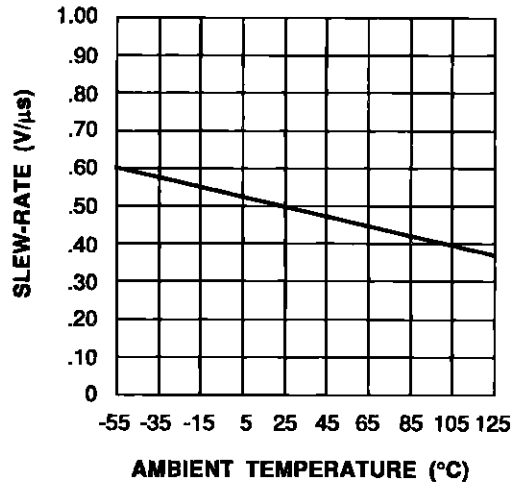

EQUIVALENT INPUT NOISE vs FREQUENCY

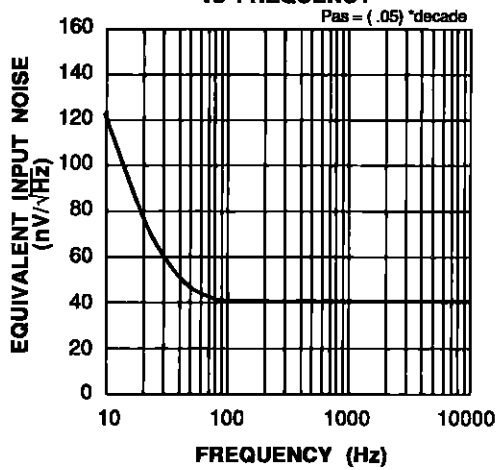

UNDISTORTED OUTPUT VOLTAGE SWING

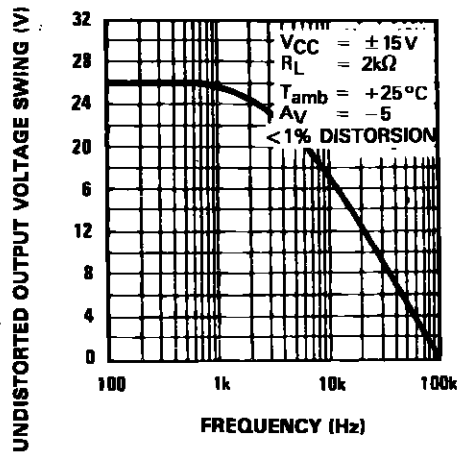

POSITIVE COMMON-MODE INPUT VOLTAGE LIMIT

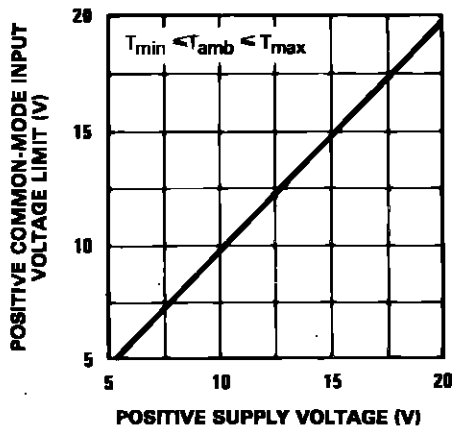

NEGATIVE COMMON-MODE INPUT VOLTAGE LIMIT

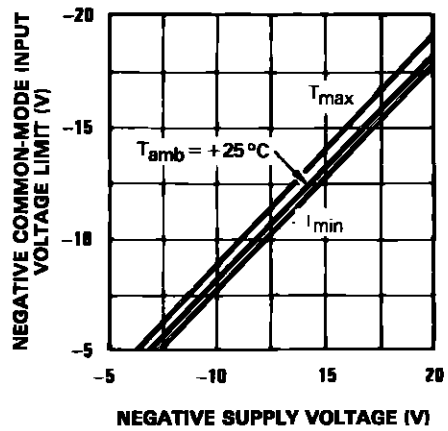

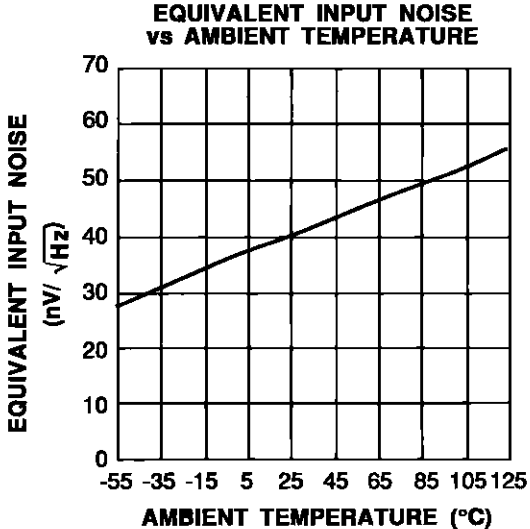
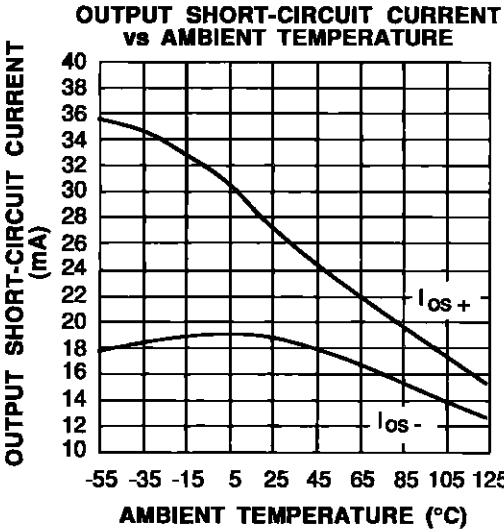

TEST CIRCUITS

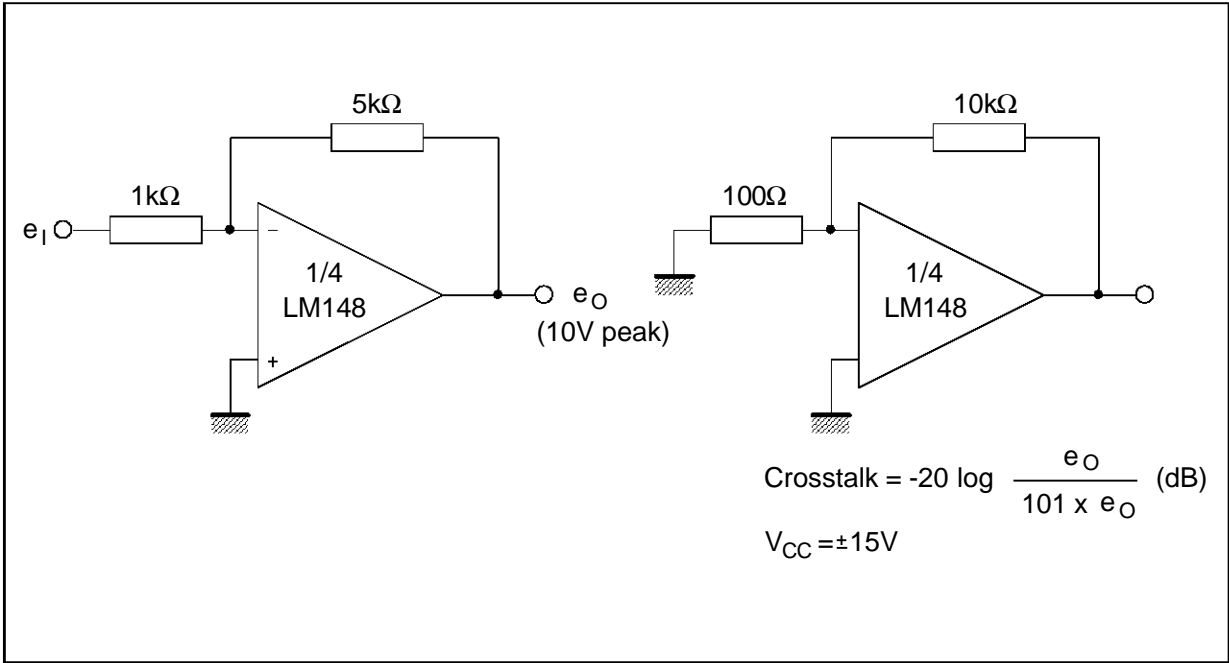

LM148 - LM248 - LM348

PACKAGE MECHANICAL DATA
14 PINS - PLASTIC DIP

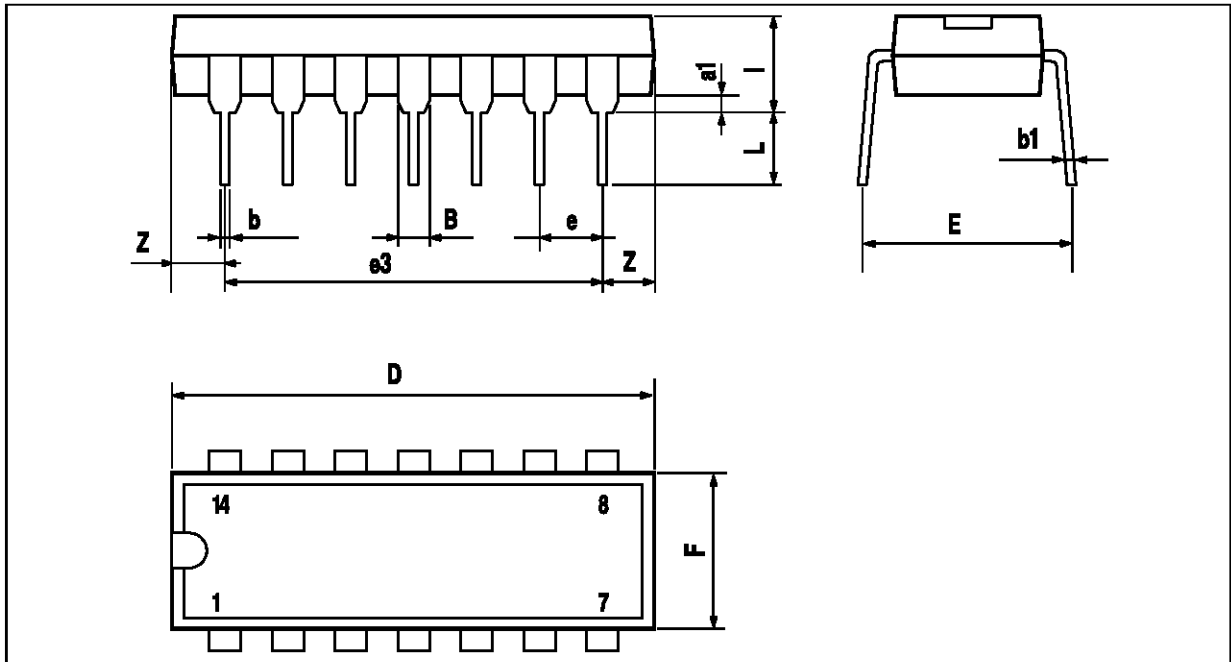

PM-DIP14LEPS

| Dimensions | Millimeters | | | Inches | | |
|------------|-------------|-------|------|--------|-------|-------|
| | Min. | Typ. | Max. | Min. | Typ. | Max. |
| a1 | 0.51 | | | 0.020 | | |
| B | 1.39 | | 1.65 | 0.055 | | 0.065 |
| b | | 0.5 | | | 0.020 | |
| b1 | | 0.25 | | | 0.010 | |
| D | | | 20 | | | 0.787 |
| E | | 8.5 | | | 0.335 | |
| e | | 2.54 | | | 0.100 | |
| e3 | | 15.24 | | | 0.600 | |
| F | | | 7.1 | | | 0.280 |
| i | | | 5.1 | | | 0.201 |
| L | | 3.3 | | | 0.130 | |
| Z | 1.27 | | 2.54 | 0.050 | | 0.100 |

DIP14,TBL

PACKAGE MECHANICAL DATA
14 PINS - PLASTIC MICROPACKAGE (SO)

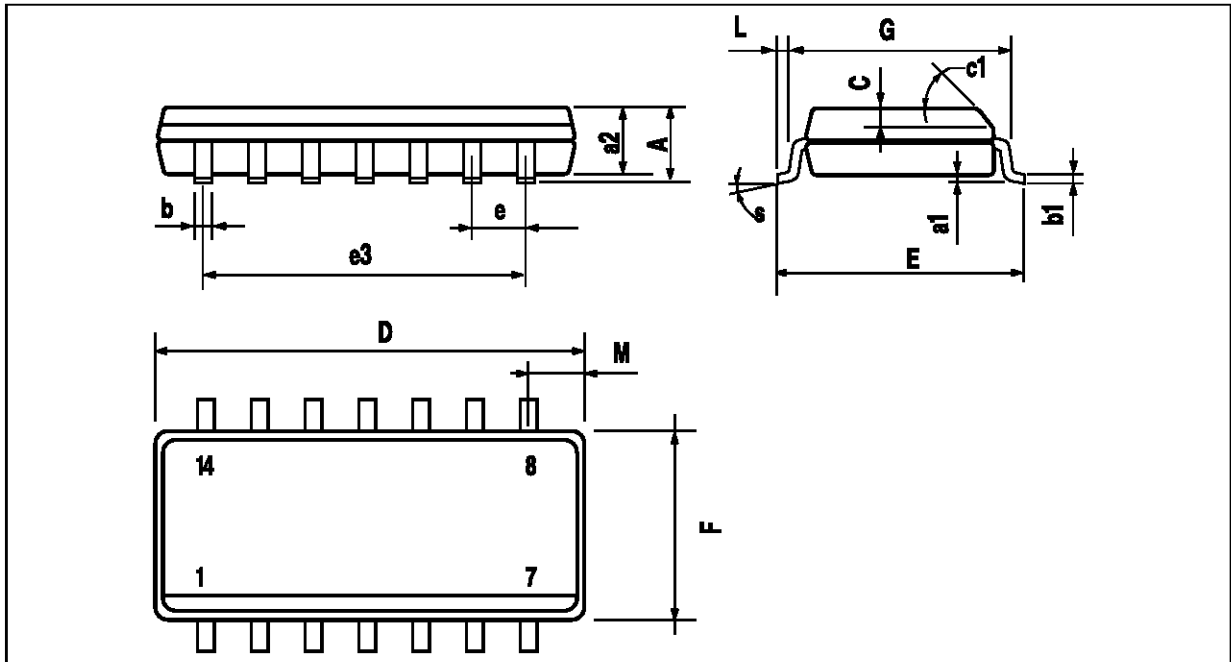

PM-SO14LEPS

| Dimensions | Millimeters | | | Inches | | |
|------------|-------------|------|------|--------|-------|-------|
| | Min. | Typ. | Max. | Min. | Typ. | Max. |
| A | | | 1.75 | | | 0.069 |
| a1 | 0.1 | | 0.2 | 0.004 | | 0.008 |
| a2 | | | 1.6 | | | 0.063 |
| b | 0.35 | | 0.46 | 0.014 | | 0.018 |
| b1 | 0.19 | | 0.25 | 0.007 | | 0.010 |
| C | | 0.5 | | | 0.020 | |
| c1 | 45° (typ.) | | | | | |
| D | 8.55 | | 8.75 | 0.336 | | 0.334 |
| E | 5.8 | | 6.2 | 0.228 | | 0.244 |
| e | | 1.27 | | | 0.050 | |
| e3 | | 7.62 | | | 0.300 | |
| F | 3.8 | | 4.0 | 0.150 | | 0.157 |
| G | 4.6 | | 5.3 | 0.181 | | 0.208 |
| L | 0.5 | | 1.27 | 0.020 | | 0.050 |
| M | | | 0.68 | | | 0.027 |
| S | 8° (max.) | | | | | |

SO14.TBL

Information furnished is believed to be accurate and reliable. However, SGS-THOMSON Microelectronics assumes no responsibility for the consequences of use of such information nor for any infringement of patents or other rights of third parties which may result from its use. No license is granted by implication or otherwise under any patent or patent rights of SGS-THOMSON Microelectronics. Specification mentioned in this publication are subject to change without notice. This publication supersedes and replaces all information previously supplied. SGS-THOMSON Microelectronics products are not authorized for use as critical components in life support devices or systems without express written approval of SGS-THOMSON Microelectronics.

© 1997 SGS-THOMSON Microelectronics – Printed in Italy – All Rights Reserved

SGS-THOMSON Microelectronics GROUP OF COMPANIES
Australia - Brazil - Canada - China - France - Germany - Hong Kong - Italy - Japan - Korea - Malaysia - Malta - Morocco
The Netherlands - Singapore - Spain - Sweden - Switzerland - Taiwan - Thailand - United Kingdom - U.S.A.

ORDER CODE :