



LC11014-241

Computer Image Signal Processing Full-Color Gray-Scale Processor

Overview

The LC11014-241 is a pseudo gray-scale processor for TFT-LCD panel displays. It allows TFT-LCD panels with 3, 4, 5 or 6-bit input digital drivers to display the equivalent of 16.7 million colors. It can also be used with XGA panels in 2-pixel parallel input/output mode.

Features

- Handles 8 bits of input data (256-level gray scale data) for each of the RGB colors
- Realizes reduced resolution loss (as compared to dithering techniques) by using intra-frame and inter-frame error diffusion processing
- Incorporates a new full-coloration algorithm, formerly best done using computers
- Operating mode selection of outputs for 3, 4, 5, or 6-bit drivers
- Selectable 2-pixel parallel input/output, serial-input parallel-output, and serial input/output operating modes
- 40MHz (parallel input/output), 65 MHz (serial input, parallel output), or 50MHz (serial input/output) maximum clock frequency
- Can operate independently of the number of displayed pixels since internal operation is controlled by the horizontal and vertical synchronization signals.
- Power-save function to stop the internal operation processing circuits, and output only the clock, sync signals and control signals
- Supports 5V input signals at 3.3V supply voltage

Package Dimensions

unit: mm

3214-SQFP144

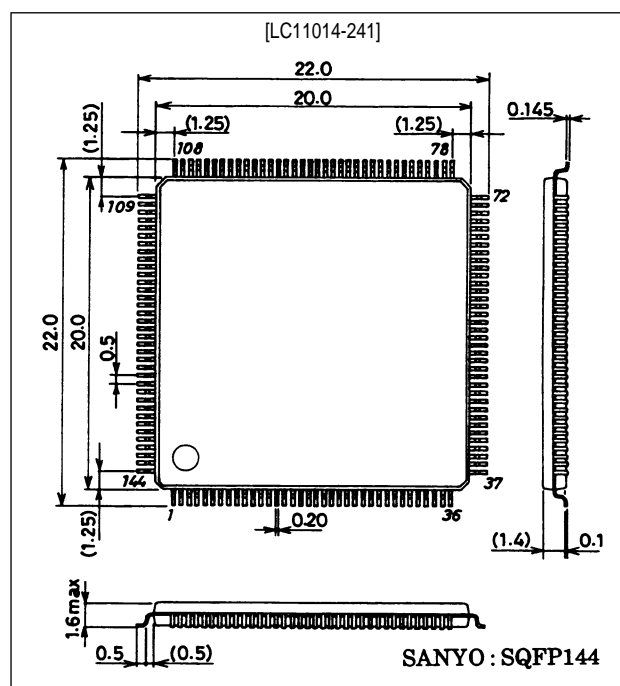

Pin Assignment

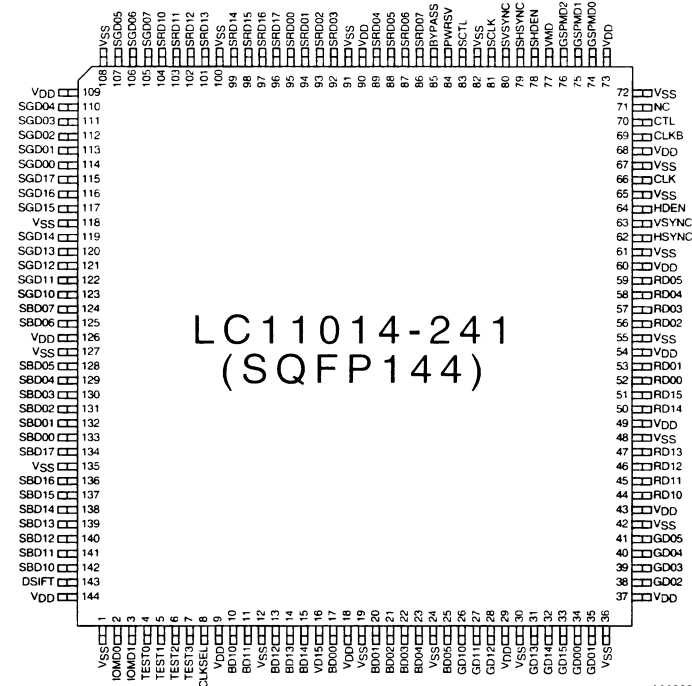

A06399

Top view

Block Diagram

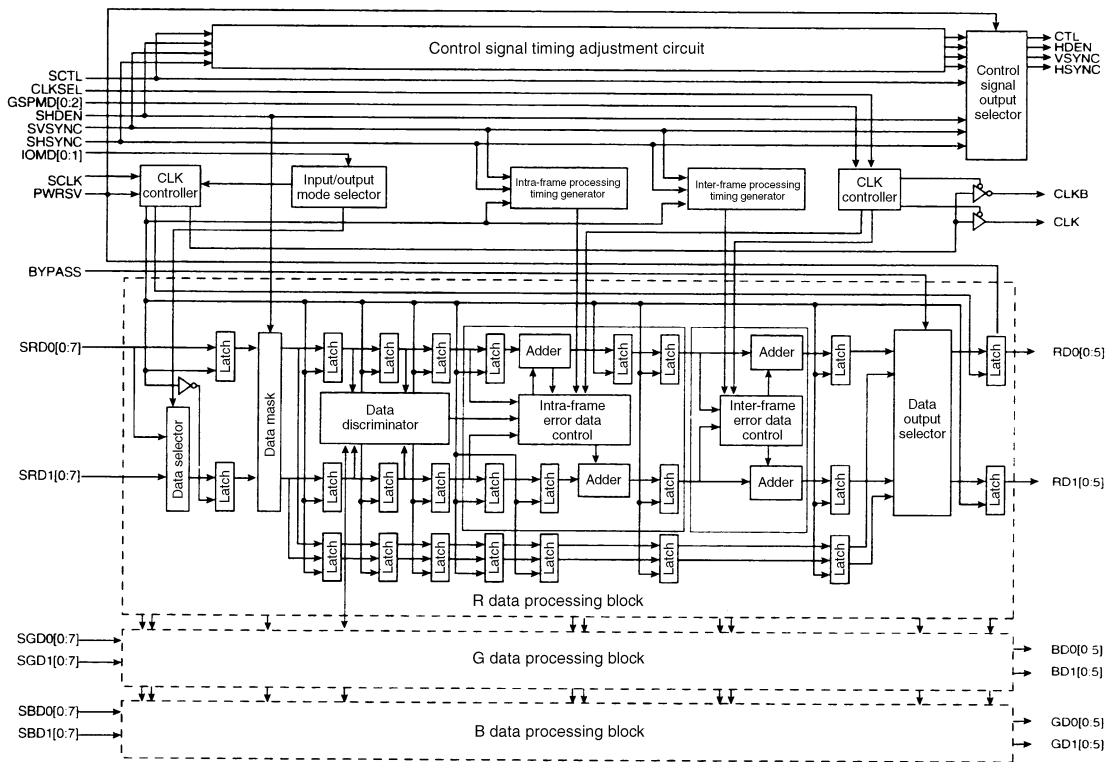

A06400

Pin Summary

I	Input
O	Output
P	Power
NC	No connection

I	I1	TTL-level pull-down input buffer
	I2	TTL-level input buffer
O	O1	2mA output buffer
	O2	4mA output buffer
	O3	4mA 3-state output buffer

No.	Name	I/O
1	V _{SS}	P
2	IOMD0	I2
3	IOMD1	I2
4	TEST0	I1
5	TEST1	I1
6	TEST2	I1
7	TEST3	I1
8	CLKSEL	I1
9	V _{DD}	P
10	BD10	O1
11	BD11	O1
12	V _{SS}	P
13	BD12	O1
14	BD13	O1
15	BD14	O1
16	BD15	O1
17	BD00	O1
18	V _{DD}	P
19	V _{SS}	P
20	BD01	O1
21	BD02	O1
22	BD03	O1
23	BD04	O1
24	V _{SS}	P
25	BD05	O1
26	GD10	O1
27	GD11	O1
28	GD12	O1
29	V _{DD}	P
30	V _{SS}	P
31	GD13	O1
32	GD14	O1
33	GD15	O1
34	GD00	O1
35	GD01	O1
36	V _{SS}	P

No.	Name	I/O
37	V _{DD}	P
38	GD02	O1
39	GD03	O1
40	GD04	O1
41	GD05	O1
42	V _{SS}	P
43	V _{DD}	P
44	RD10	O1
45	RD11	O1
46	RD12	O1
47	RD13	O1
48	V _{SS}	P
49	V _{DD}	P
50	RD14	O1
51	RD15	O1
52	RD00	O1
53	RD01	O1
54	V _{DD}	P
55	V _{SS}	P
56	RD02	O1
57	RD03	O1
58	RD04	O1
59	RD05	O1
60	V _{DD}	P
61	V _{SS}	P
62	HSYNC	O2
63	VSYNC	O2
64	HDEN	O2
65	V _{SS}	P
66	CLK	O3
67	V _{SS}	P
68	V _{DD}	P
69	CLKB	O3
70	CTL	O1
71	NC	NC
72	V _{SS}	P

No.	Name	I/O
73	V _{DD}	P
74	GSPMD0	I2
75	GSPMD1	I2
76	GSPMD2	I2
77	VMD	I1
78	SHDEN	I2
79	SHSYNC	I2
80	SVSYNC	I2
81	SCLK	I2
82	V _{SS}	P
83	SCTL	I1
84	PWRSV	I1
85	BYPASS	I1
86	SRD07	I2
87	SRD06	I2
88	SRD05	I2
89	SRD04	I2
90	V _{DD}	P
91	V _{SS}	P
92	SRD03	I2
93	SRD02	I2
94	SRD01	I2
95	SRD00	I2
96	SRD17	I2
97	SRD16	I2
98	SRD15	I2
99	SRD14	I2
100	V _{SS}	P
101	SRD13	I2
102	SRD12	I2
103	SRD11	I2
104	SRD10	I2
105	SGD07	I2
106	SGD06	I2
107	SGD05	I2
108	V _{SS}	P

No.	Name	I/O
109	V _{DD}	P
110	SGD04	I2
111	SGD03	I2
112	SGD02	I2
113	SGD01	I2
114	SGD00	I2
115	SGD17	I2
116	SGD16	I2
117	SGD15	I2
118	V _{SS}	P
119	SGD14	I2
120	SGD13	I2
121	SGD12	I2
122	SGD11	I2
123	SGD10	I2
124	SBD07	I2
125	SBD06	I2
126	V _{DD}	P
127	V _{SS}	P
128	SBD05	I2
129	SBD04	I2
130	SBD03	I2
131	SBD02	I2
132	SBD01	I2
133	SBD00	I2
134	SBD17	I2
135	V _{SS}	P
136	SBD16	I2
137	SBD15	I2
138	SBD14	I2
139	SBD13	I2
140	SBD12	I2
141	SBD11	I2
142	SBD10	I2
143	DSIFT	I1
144	V _{DD}	P

Pin Functions

Symbol	Pin No.	I/O	Function																																																																																								
V _{DD}	9, 18, 29, 37, 43, 49, 54, 60, 68, 73, 90, 109, 126, 144	–	Supply voltage (+3.3V)																																																																																								
V _{SS}	1, 12, 19, 24, 30, 36, 42, 48, 55, 61, 65, 67, 72, 82, 91, 100, 108, 118, 127, 135	–	Ground (0V)																																																																																								
GSPMD [0:2]	74 to 76	I	<p>Mode selection signals [0 to 2] for the gray-scale mode. The setting process for the mode selection lines is described below. GSPMD0 is the LSB and GSPMD2 is the MSB.</p> <table border="1"> <thead> <tr> <th colspan="2">Gray-scale mode</th> <th>0</th> <th>1</th> <th>2</th> <th>3</th> <th>4</th> <th>5</th> <th>6</th> <th>7</th> </tr> </thead> <tbody> <tr> <td colspan="2">GSPMD0</td> <td>L</td> <td>H</td> <td>L</td> <td>H</td> <td>L</td> <td>H</td> <td>L</td> <td>H</td> </tr> <tr> <td colspan="2">GSPMD1</td> <td>L</td> <td>L</td> <td>H</td> <td>H</td> <td>L</td> <td>L</td> <td>H</td> <td>H</td> </tr> <tr> <td colspan="2">GSPMD2</td> <td>L</td> <td>L</td> <td>L</td> <td>L</td> <td>H</td> <td>H</td> <td>H</td> <td>H</td> </tr> <tr> <td rowspan="2">Processing</td> <td>Intra-frame processing</td> <td>Yes</td> <td>Yes</td> <td>Yes</td> <td>Yes</td> <td rowspan="3">Reserved</td> <td>Yes</td> <td>Yes</td> <td>Yes</td> </tr> <tr> <td>Inter-frame processing</td> <td>Yes</td> <td>Yes</td> <td>Yes</td> <td>Yes</td> <td>No</td> <td>No</td> <td>No</td> </tr> <tr> <td colspan="2">Number of valid input bits</td> <td>8</td> <td>8</td> <td>8</td> <td>8</td> <td>8</td> <td>8</td> <td>8</td> </tr> <tr> <td colspan="2">Number of output bits</td> <td>3</td> <td>4</td> <td>5</td> <td>6</td> <td>4</td> <td>5</td> <td>6</td> </tr> </tbody> </table> <table border="1"> <thead> <tr> <th>Gray-scale mode</th> <th>LCD module</th> </tr> </thead> <tbody> <tr> <td>0</td> <td>Operating mode for TFT LCD modules with 3-bit source driver</td> </tr> <tr> <td>1</td> <td>Operating mode for TFT LCD modules with 4-bit source driver</td> </tr> <tr> <td>2, 6</td> <td>Operating mode for TFT LCD modules with 5-bit source driver</td> </tr> <tr> <td>3, 7</td> <td>Operating mode for TFT LCD modules with 6-bit source driver</td> </tr> <tr> <td>5</td> <td>Operating mode for TFT LCD modules with 3-bit source driver that perform FRC or other inter-frame processing</td> </tr> </tbody> </table> <p>Do not use gray-scale modes 0 to 3 with TFT LCD modules that perform FRC or other inter-frame processing.</p>	Gray-scale mode		0	1	2	3	4	5	6	7	GSPMD0		L	H	L	H	L	H	L	H	GSPMD1		L	L	H	H	L	L	H	H	GSPMD2		L	L	L	L	H	H	H	H	Processing	Intra-frame processing	Yes	Yes	Yes	Yes	Reserved	Yes	Yes	Yes	Inter-frame processing	Yes	Yes	Yes	Yes	No	No	No	Number of valid input bits		8	8	8	8	8	8	8	Number of output bits		3	4	5	6	4	5	6	Gray-scale mode	LCD module	0	Operating mode for TFT LCD modules with 3-bit source driver	1	Operating mode for TFT LCD modules with 4-bit source driver	2, 6	Operating mode for TFT LCD modules with 5-bit source driver	3, 7	Operating mode for TFT LCD modules with 6-bit source driver	5	Operating mode for TFT LCD modules with 3-bit source driver that perform FRC or other inter-frame processing
Gray-scale mode		0	1	2	3	4	5	6	7																																																																																		
GSPMD0		L	H	L	H	L	H	L	H																																																																																		
GSPMD1		L	L	H	H	L	L	H	H																																																																																		
GSPMD2		L	L	L	L	H	H	H	H																																																																																		
Processing	Intra-frame processing	Yes	Yes	Yes	Yes	Reserved	Yes	Yes	Yes																																																																																		
	Inter-frame processing	Yes	Yes	Yes	Yes		No	No	No																																																																																		
Number of valid input bits		8	8	8	8		8	8	8																																																																																		
Number of output bits		3	4	5	6	4	5	6																																																																																			
Gray-scale mode	LCD module																																																																																										
0	Operating mode for TFT LCD modules with 3-bit source driver																																																																																										
1	Operating mode for TFT LCD modules with 4-bit source driver																																																																																										
2, 6	Operating mode for TFT LCD modules with 5-bit source driver																																																																																										
3, 7	Operating mode for TFT LCD modules with 6-bit source driver																																																																																										
5	Operating mode for TFT LCD modules with 3-bit source driver that perform FRC or other inter-frame processing																																																																																										
IOMD [0:1]	2, 3	I	<p>Input/output mode select pins. The input/output mode selection lines are described below. IOMD0 is the LSB and IOMD1 is the MSB.</p> <table border="1"> <thead> <tr> <th>Input/output mode</th> <th>0</th> <th>1</th> <th>2</th> <th>3</th> </tr> </thead> <tbody> <tr> <td>IOMD0</td> <td>L</td> <td>H</td> <td>L</td> <td>H</td> </tr> <tr> <td>IOMD1</td> <td>L</td> <td>L</td> <td>H</td> <td>H</td> </tr> <tr> <td>Input</td> <td>Parallel</td> <td>Serial</td> <td>Serial</td> <td rowspan="2">Reserved</td> </tr> <tr> <td>Output</td> <td>Parallel</td> <td>Parallel</td> <td>Serial</td> </tr> </tbody> </table> <table border="1"> <thead> <tr> <th>Input/output mode</th> <th>LCD module</th> </tr> </thead> <tbody> <tr> <td>0</td> <td>XGA-compatible 2-pixel parallel input interface TFT LCD panels</td> </tr> <tr> <td>1</td> <td>2-pixel parallel input interface TFT LCD panels (serial input is converted to parallel internally)</td> </tr> <tr> <td>2</td> <td>Serial input interface VGA and SVGA TFT LCD panels</td> </tr> </tbody> </table>	Input/output mode	0	1	2	3	IOMD0	L	H	L	H	IOMD1	L	L	H	H	Input	Parallel	Serial	Serial	Reserved	Output	Parallel	Parallel	Serial	Input/output mode	LCD module	0	XGA-compatible 2-pixel parallel input interface TFT LCD panels	1	2-pixel parallel input interface TFT LCD panels (serial input is converted to parallel internally)	2	Serial input interface VGA and SVGA TFT LCD panels																																																								
Input/output mode	0	1	2	3																																																																																							
IOMD0	L	H	L	H																																																																																							
IOMD1	L	L	H	H																																																																																							
Input	Parallel	Serial	Serial	Reserved																																																																																							
Output	Parallel	Parallel	Serial																																																																																								
Input/output mode	LCD module																																																																																										
0	XGA-compatible 2-pixel parallel input interface TFT LCD panels																																																																																										
1	2-pixel parallel input interface TFT LCD panels (serial input is converted to parallel internally)																																																																																										
2	Serial input interface VGA and SVGA TFT LCD panels																																																																																										
VMD	77	I	Gray-scale processing algorithm select pin. The LC11011-141 algorithm is selected when high. Normal mode is selected when low or open.																																																																																								
SCLK	81	I	Clock signal input. Data is processed according to this clock signal.																																																																																								
DSIFT	143	I	In input/output mode 1, data is shifted out on both xD0 and xD1 when high.																																																																																								

LC11014-241

Symbol	Pin No.	I/O	Function
SRD0 [7:0]	86 to 89, 92 to 95	I	Input pins for red, green and blue gray-scale data. SRD07, SRD17, SGD07, SGD17, SBD07, SBD17 are the MSBs. SRD00, SRD10, SGD00, SGD10, SBD00, SBD10 are the LSBs. Input data 00 _H corresponds to minimum brightness, and FF _H to maximum brightness. Note that correct gray-scale display does not occur when an input is set to either the minimum or maximum. If 2-pixel data is set on both S×D0 and S×D1, the display data on S×D0 is displayed first. In input/output modes 1 and 2, inputs SRD1[0:7], SGD1[0:7] and SBD1[0:7] should be tied high or low.
SRD1 [7:0]	96 to 99, 101 to 104	I	
SGD0 [7:0]	105 to 107, 110 to 114	I	
SGD1 [7:0]	115 to 117, 119 to 123	I	
SBD0 [7:0]	124, 125, 128 to 133	I	
SBD1 [7:0]	134, 136 to 142	I	
HSYNC	79	I	Horizontal and vertical synchronization signal inputs. These are the sources for the HSYNC and VSYNC signals. They are also used to control data processing. Active-low signals.
VSYNC	80	I	
SHDEN	78	I	Horizontal data valid-period signal input. Set this pin high during periods when the horizontal data is valid. If this signal is not used, tie it high and set the input data to 0 during the horizontal blanking period.
SCTL	83	I	LCD control signal input. Input control signal that must be matched to the data signal timing. This is the source for the CTL signal. If the CTL signal is not used, there is no internal signal processing of this input and hence there is no need to input the SCTL signal.
CLKSEL	8	I	CLKSEL is the dot clock output select pin. It is used to select the output mode of the dot clock signal output pin.
CLK	66	O	In input/output modes 0 and 2: When CLKSEL is low, a signal with the opposite phase from SCLK is output from CLK. When CLKSEL is high, a signal with the same phase as SCLK is output from CLKB. In input/output mode 1: When CLKSEL is low, a signal with half the frequency of SCLK is output from CLK. When CLKSEL is high, a signal with the opposite phase from CLK is output from CLKB.
CLKB	69	O	
RD0 [0:5]	52 to 53, 56 to 59	O	Red, green and blue gray-scale data output pins. RD05, RD15, GD05, GD15, BD05, BD15 are the MSBs. RD00, RD10, GD00, GD10, BD00, BD10 are the LSBs. If a 2-pixel data set is on ×D0 and ×D1, the data on ×D0 is displayed first. In input/output modes 1 and 2, outputs RD1[0:5], GD1[0:5] and BD1[0:5] are low. In 3-bit data output mode: RD03, RD13, GD03, GD13, BD03, BD13 are the LSBs. RD0[2:0], RD1[2:0], GD0[2:0], GD1[2:0], BD0[2:0], BD1[2:0] are low. In 4-bit data output mode: RD02, RD12, GD02, GD12, BD02, BD12 are the LSBs. RD0[1:0], RD1[1:0], GD0[1:0], GD1[1:0], BD0[1:0], BD1[1:0] are low. In 3-bit data output mode: RD01, RD11, GD01, GD11, BD01, BD11 are the LSBs. RD0[0], RD1[0], GD0[0], GD1[0], BD0[0], BD1[0] are low.
RD1 [0:5]	44 to 47, 50, 51	O	
GD0 [0:5]	34, 35, 38 to 41	O	
GD1 [0:5]	26 to 28, 31 to 33	O	
BD0 [0:5]	17, 20 to 23, 25	O	
BD1 [0:5]	10, 11, 13 to 16	O	
HSYNC	62	O	Vertical and horizontal synchronization signal outputs. To match the data signal timing, these outputs are delayed with respect to their input signals. In input/output mode 0, they are delayed by 8 SCLK cycles, and in input/output modes 1 and 2, they are delayed by 16 SCLK cycles. When PWRSV is high, these signals are output without being latched internally.
VSYNC	63	O	
HDEN	64	O	Horizontal data valid-period signal output. To match the data signal timing, this output is delayed with respect to the input signal. In input/output mode 0, they are delayed by 8 SCLK cycles, and in input/output modes 1 and 2, they are delayed by 16 SCLK cycles. When PWRSV is high, this signal is output without being latched internally.
CTL	70	O	LCD control signal output. To match the data signal timing, this output is delayed with respect to the SCTL input signal. In input/output mode 0, they are delayed by 8 SCLK cycles, and in input/output modes 1 and 2, they are delayed by 16 SCLK cycles. When PWRSV is high, this signal is output without being latched internally.
PWRSV	84	I	Power-save control input. When this input goes high, the internal clock stops and the LSI enters power-save mode. Output data are held high. VSYNC, HSYNC, HDEN and CTL control signals, and either CLK or CLKB are output without being latched internally. Tie low or leave open for normal operation.
BYPASS	85	I	Gray-scale processing bypass pin. When high, the input signals are latched and output without change. When a high-level input on this pin is sampled on the falling edge of SCLK: in input/output mode 0, output is delayed by 8 SCLK cycles, and in input/output modes 1 and 2, output is delayed by 16 SCLK cycles.
TEST [0:3]	4 to 7	I	Test pins [0:3]; left open for normal operation
NC	71	–	Must be left open.

Specifications

Absolute Maximum Ratings at $V_{SS} = 0V$

Parameter	Symbol	Conditions	Ratings	Unit
Maximum supply voltage	$V_{DD\ max}$		-0.3 to +4.6	V
Input voltage	V_{IN}		-0.3 to +5.8	V
Output voltage	V_O		-0.3 to $V_{DD} + 0.3$	V
Operating temperature	T_{opr}		0 to +70	°C
Storage temperature	T_{stg}		-40 to +125	°C

Allowable Operating Ranges at $T_a = 0$ to +70°C

Parameter	Symbol	Conditions	min	typ	max	Unit
Supply voltage	V_{DD}		3.15	3.3	3.45	V
Input voltage	V_{IN}		0	-	5.5	V
Clock frequency ¹	f_{CLK}	Input/output mode 0	-	-	40	MHz
Clock frequency ¹	f_{CLK}	Input/output mode 1	-	-	65	MHz
Clock frequency	f_{CLK}	Input/output mode 2	-	-	50	MHz

1. 1024 × 768; At timing ≥ 60Hz (XGA timing), the display interval is less than 75%.

DC Characteristics at $T_a = 0$ to +70°C, $V_{SS} = 0V$, $V_{DD} = 3.15$ to 3.45V

Parameter	Symbol	Conditions	min	typ	max	Unit
High-level input voltage	V_{IH}		2.0	-	-	V
Low-level input voltage	V_{IL}		-	-	0.5	V
High-level output voltage	V_{OH}	$I_{OH} = -2mA$	$V_{DD} - 0.6$	-	-	V
Low-level output voltage	V_{OL}	$I_{OL} = 2mA$	-	-	0.4	V
Operating current drain ¹	I_{CC}		-	110	170	mA
Power-save current drain ²	I_{CPS}		-	-	30	mA
Standby current drain ³	I_{CST}		-	-	100	μA

1. Input/output mode 0, gray-scale mode 7, $f_{CLK} = 32.5MHz$, $V_{DD} = 3.3V$, $C_L = 15pF$, (1024 × 768, measured with 60Hz XGA timing)

2. Input/output mode 0, PWRSV = low, $f_{CLK} = 32.5MHz$, $V_{DD} = 3.3V$, $C_L = 15pF$ (control signals: VSYNC, HSYNC, HDEN, CTL, CLK), all other outputs open

3. $V_{DD} = 3.3V$, all outputs open, all input pins tied low

Switching Characteristics at $T_a = 0$ to $+70^\circ\text{C}$, $V_{SS} = 0\text{V}$, $V_{DD} = 3.15$ to 3.45V , $C_L = 15\text{pF}$

Parameter	Symbol	min	typ	max	Unit
SCLK cycle time ¹	Tsclk	25	–	–	ns
SCLK cycle time ^{2,3}	Tsclk	15.4	–	–	ns
SCLK cycle time ⁴	Tsclk	20	–	–	ns
SCLK high-level pulse width ¹	Tschw	10	–	–	ns
SCLK high-level pulse width ^{2,3}	Tschw	6.2	–	–	ns
SCLK high-level pulse width ⁴	Tschw	8	–	–	ns
SCLK low-level pulse width ¹	Tsclw	10	–	–	ns
SCLK low-level pulse width ^{2,3}	Tsclw	6.2	–	–	ns
SCLK low-level pulse width ⁴	Tsclw	8	–	–	ns
HSYNC low-level pulse width	Thpw	2Tsclk	–	–	ns
HSYNC high-level pulse width	Tvpw	2Tsclk	–	–	ns
CLK propagation delay time ¹	Tpckh	7	11	22	ns
CLK propagation delay time ¹	Tpckl	7	11	22	ns
CLKB propagation delay time ¹	Tpcbh	6	10	20	ns
CLKB propagation delay time ¹	Tpcbl	7	12	24	ns
CLK propagation delay time ^{2,3}	Tpckh	7	12	24	ns
CLK propagation delay time ^{2,3}	Tpckl	8	13	25	ns
CLKB propagation delay time ^{2,3}	Tpcbh	7	12	23	ns
CLKB propagation delay time ^{2,3}	Tpcbl	8	13	26	ns
CLK propagation delay time ⁴	Tpckh	7	11	22	ns
CLK propagation delay time ⁴	Tpckl	7	11	22	ns
CLKB propagation delay time ⁴	Tpcbh	6	10	20	ns
CLKB propagation delay time ⁴	Tpcbl	8	12	25	ns
Data setup time	Tdsu	5	–	–	ns
Data hold time	Tdhd	5	–	–	ns
Data output propagation delay time ¹	Tpdata	8Tsclk + 9	8Tsclk + 14	8Tsclk + 28	ns
Data output propagation delay time ^{2,3}	Tpdt0sl	16Tsclk + 9	16Tsclk + 15	16Tsclk + 29	ns
Data output propagation delay time ^{2,3}	Tpdt1sl	15Tsclk + 9	15Tsclk + 15	15Tsclk + 30	ns
Data output propagation delay time ^{2,3}	Tpdt0sh	15Tsclk + 9	15Tsclk + 15	15Tsclk + 29	ns
Data output propagation delay time ^{2,3}	Tpdt1sh	16Tsclk + 9	16Tsclk + 15	16Tsclk + 30	ns
Data output propagation delay time ⁴	Tdatass	16Tsclk + 9	16Tsclk + 14	16Tsclk + 27	ns
Control signal setup time	Tcsu	5	–	–	ns
Control signal hold time	Tchd	5	–	–	ns
Control signal propagation delay time ¹	Tpctl	8Tsclk + 8	8Tsclk + 13	8Tsclk + 24	ns
Control signal propagation delay time ^{2,3,4}	Tpctsp	16Tsclk + 8	16Tsclk + 13	16Tsclk + 26	ns

1. Parallel input, parallel output
2. Serial input, parallel output (1H number of pixels is even)
3. Serial input, parallel output (1H number of pixels is odd)
4. Serial input, serial output

Timing Diagrams

Input/output mode 0 (parallel input, serial output)

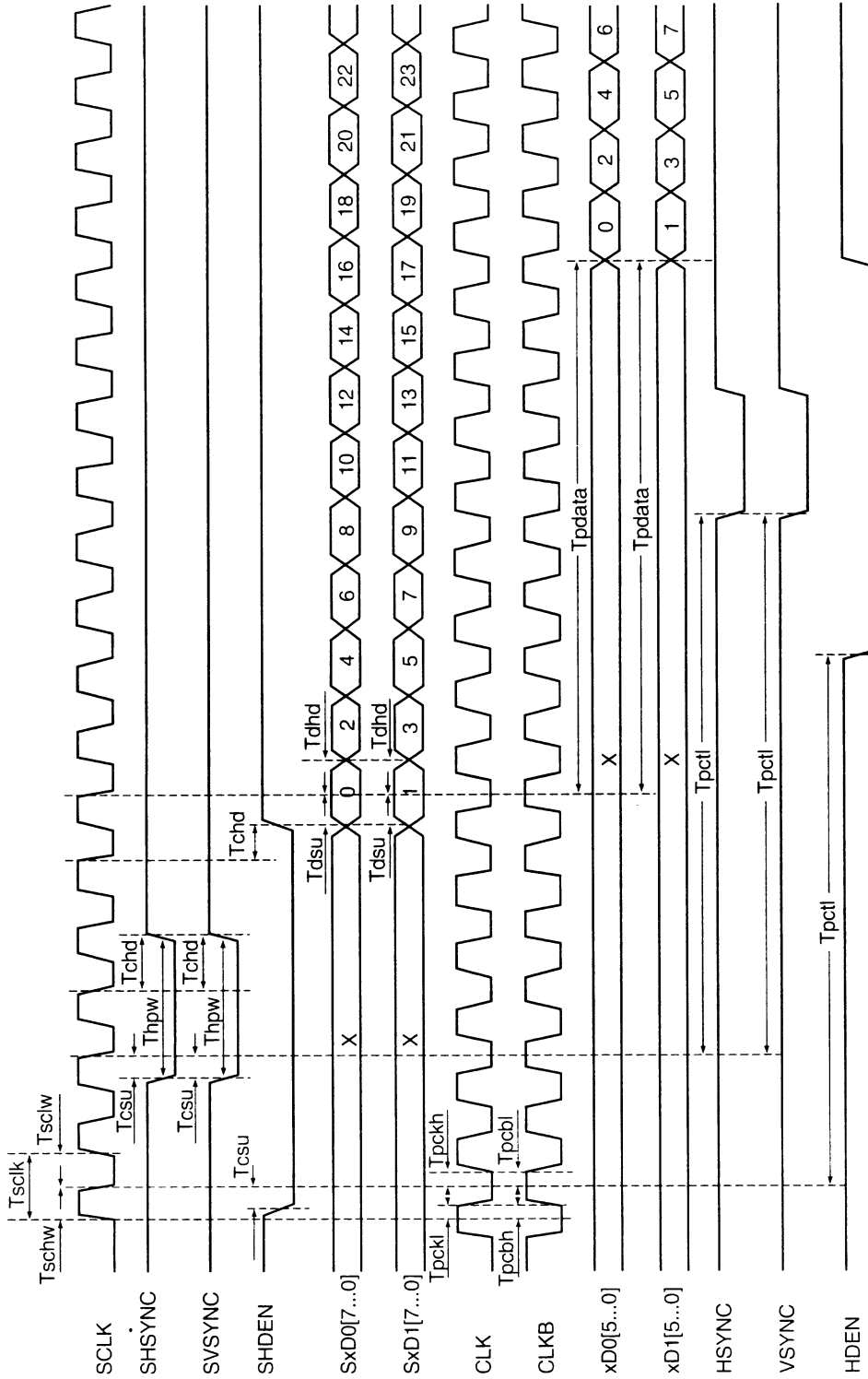

AN1001

Input/output mode 1 (serial input, parallel output: 1H number of pixels is even)

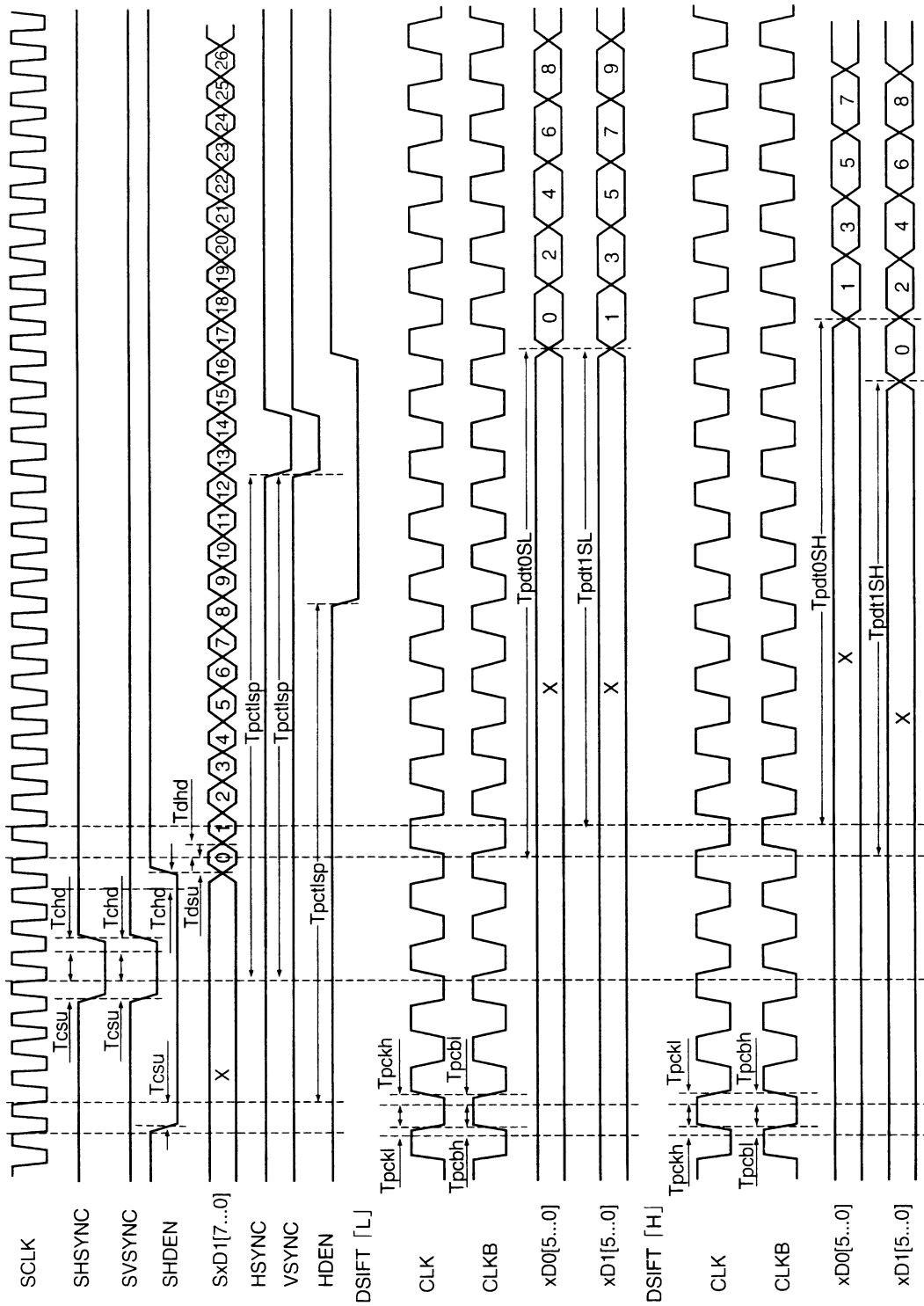

A05/02

Input/output mode 1 (serial input, parallel output: 1H number of pixels is odd)

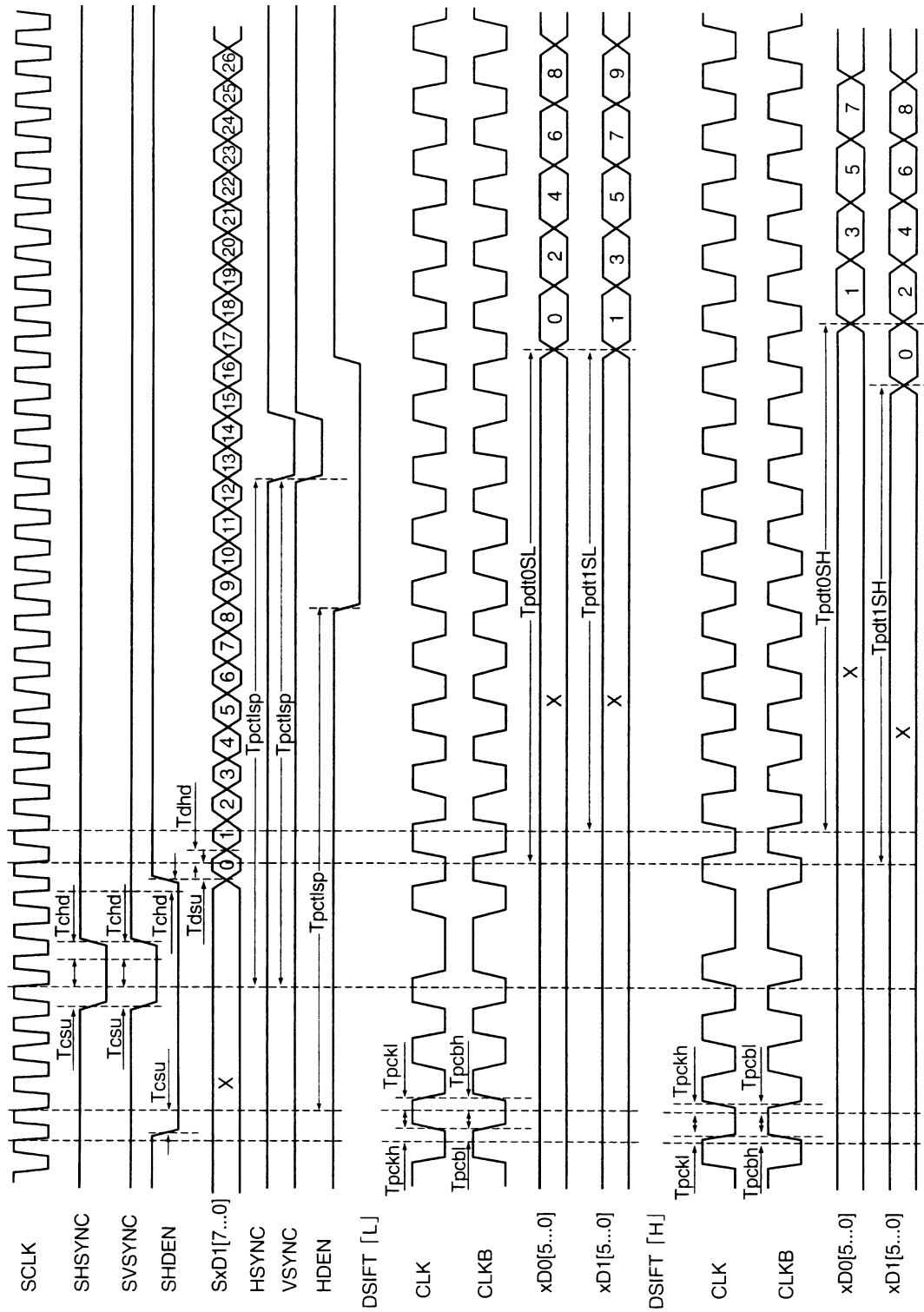

A06503

Input/output mode 2 (serial input, serial output)

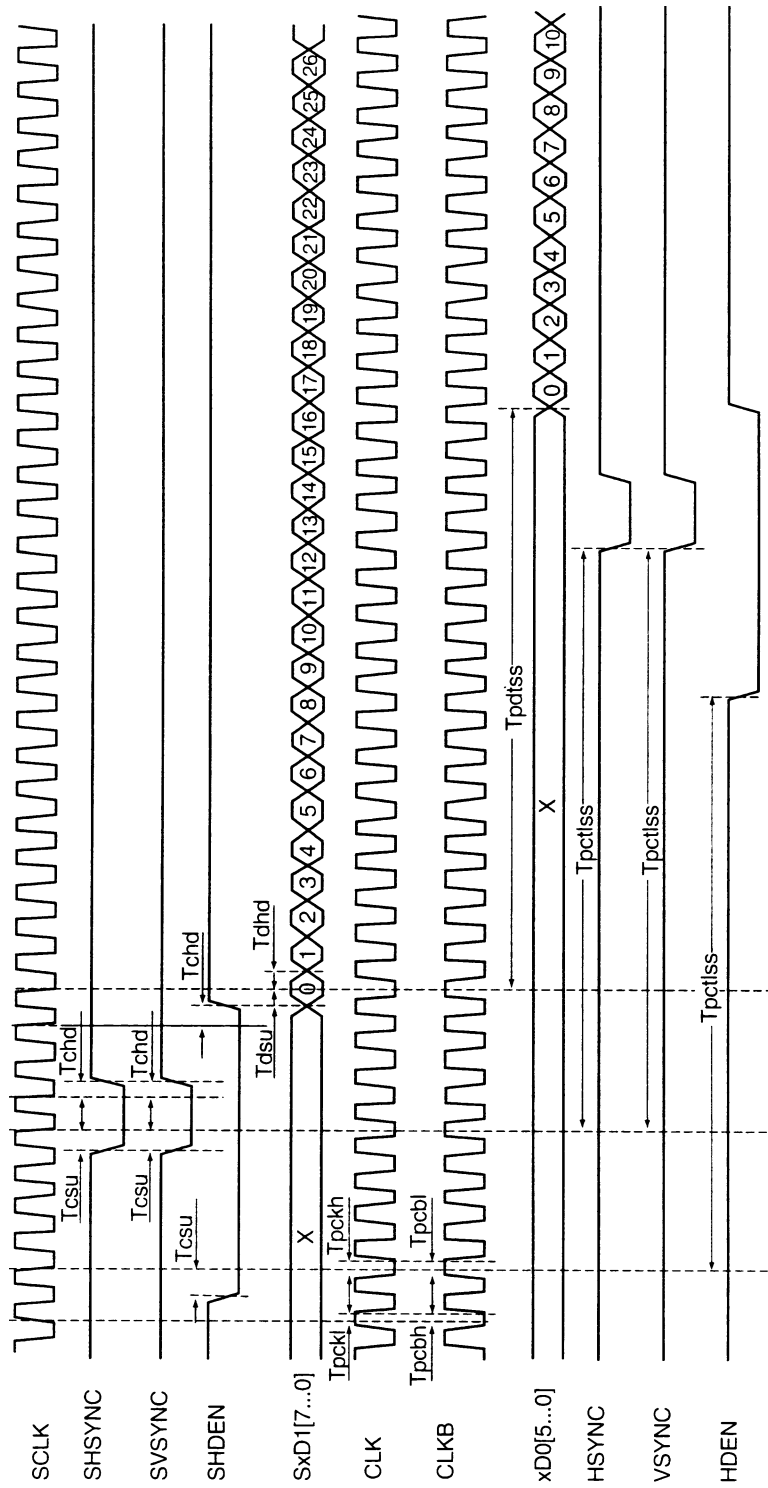

AD6404

Usage Notes

Parallel input, parallel output

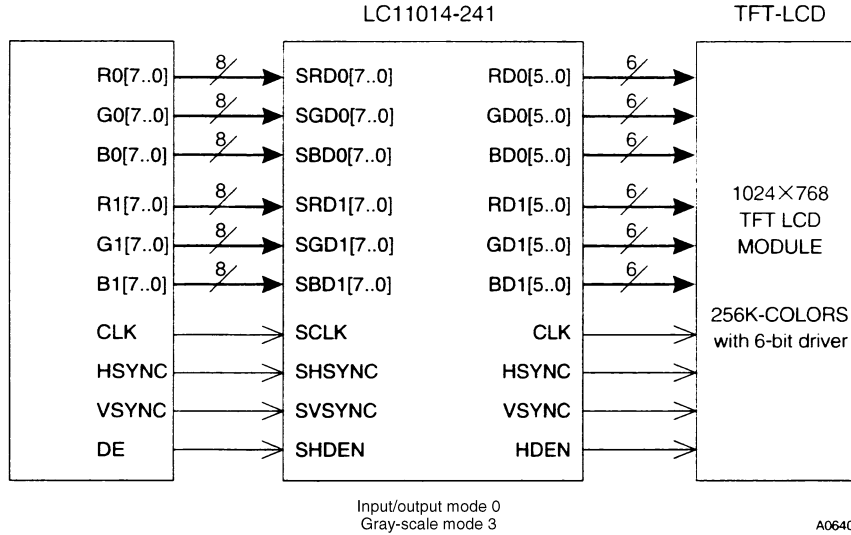

Serial input, parallel output

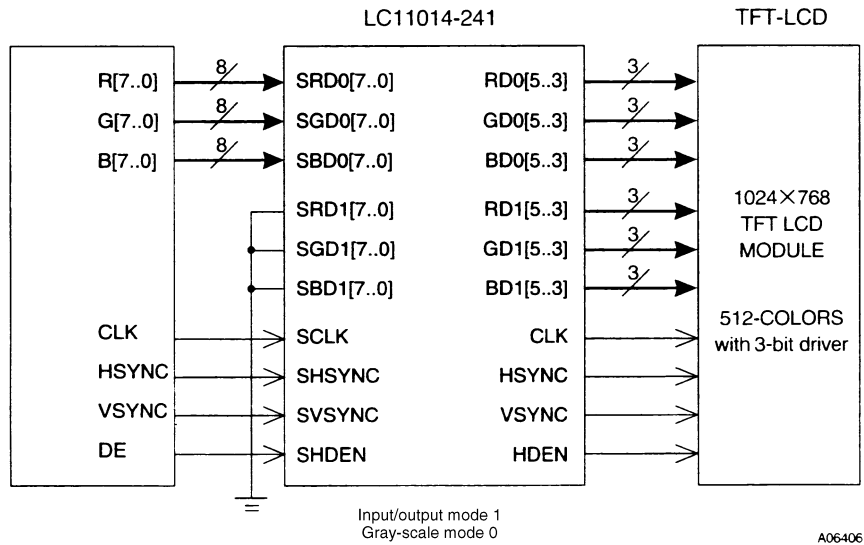

Serial input, serial output

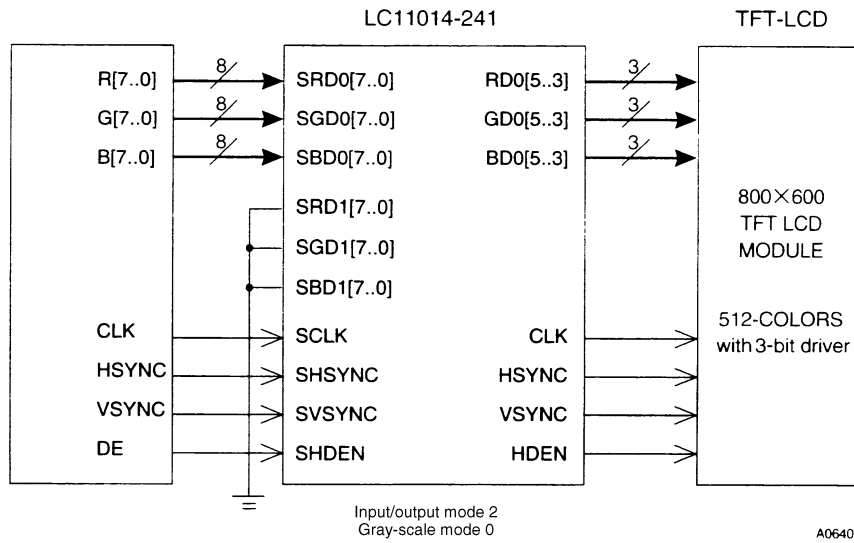

Usage Note

Since this LSI performs spatial modulation using an error diffusion algorithm, patterns that differ from the original images may be displayed for certain display pattern and gray-scale mode combinations.

- No products described or contained herein are intended for use in surgical implants, life-support systems, aerospace equipment, nuclear power control systems, vehicles, disaster/crime-prevention equipment and the like, the failure of which may directly or indirectly cause injury, death or property loss.
- Anyone purchasing any products described or contained herein for an above-mentioned use shall:
 - ① Accept full responsibility and indemnify and defend SANYO ELECTRIC CO., LTD., its affiliates, subsidiaries and distributors and all their officers and employees, jointly and severally, against any and all claims and litigation and all damages, cost and expenses associated with such use:
 - ② Not impose any responsibility for any fault or negligence which may be cited in any such claim or litigation on SANYO ELECTRIC CO., LTD., its affiliates, subsidiaries and distributors or any of their officers and employees, jointly or severally.
- Information (including circuit diagrams and circuit parameters) herein is for example only; it is not guaranteed for volume production. SANYO believes information herein is accurate and reliable, but no guarantees are made or implied regarding its use or any infringements of intellectual property rights or other rights of third parties.

This catalog provides information as of June, 1997. Specifications and information herein are subject to change without notice.