



LB1651D

Dual Bidirectional Motor Driver

Overview

The LB1651D is a dual bidirectional motor driver that is designed to drive motors directly by TTL outputs. It provides the functions of bidirectional motor drive, brake that are determined by two inputs and the inhibit function that brings the output to a high impedance state.

Applications

- Multi DC motor driver
- Bidirectional motor driver
- Bipolar stepping motor driver

Features

- High output current (1 A/ch)
- Wide operating voltage range (4.5 to 36 V)
- Inhibit function
- Direct drive made possible by TTL, CMOS IC
- High noise margin

Specifications

Absolute Maximum Ratings at $T_a = 25^\circ\text{C}$

Parameter	Symbol	Conditions	Ratings	Unit
Maximum supply voltage	V_{CC1}		36	V
Logic supply voltage	V_{CC2}		36	V
Input voltage	V_{IN}		7	V
Inhibit voltage	V_{inh}		7	V
Peak output current	I_{OUT}	1 ms non-repetitive	2	A
Allowable power dissipation	$P_d \text{ max}$	* With specified board	2.5	W
Operating temperature	T_{opr}		-20 to +80	$^\circ\text{C}$
Storage temperature	T_{stg}		-40 to +150	$^\circ\text{C}$

* Specified board: $114 \times 76 \times 1.6 \text{ mm}^3$

■ Any and all SANYO products described or contained herein do not have specifications that can handle applications that require extremely high levels of reliability, such as life-support systems, aircraft's control systems, or other applications whose failure can be reasonably expected to result in serious physical and/or material damage. Consult with your SANYO representative nearest you before using any SANYO products described or contained herein in such applications.

■ SANYO assumes no responsibility for equipment failures that result from using products at values that exceed, even momentarily, rated values (such as maximum ratings, operating condition ranges, or other parameters) listed in products specifications of any and all SANYO products described or contained herein.

Package Dimensions

unit : mm

3196-DIP30SD

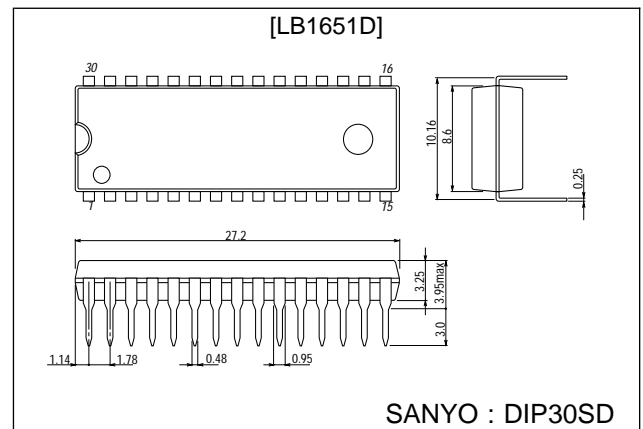

LB1651D

Allowable Operating Conditions at $T_a = 25^\circ\text{C}$

Parameter	Symbol	Conditions	Rating	Unit
Supply voltage	V_{CC1}		4.5 to 36	V
Logic supply voltage	V_{CC2}		4.5 to 36	V

Electrical Characteristics at $T_a = 25^\circ\text{C}$, $V_{CC1} = 24\text{ V}$, $V_{CC2} = 5\text{ V}$

Parameter	Symbol	Conditions	min	typ	max	Unit
Supply current (Per channel)	I_{CC1}	$V_{IN} = L, I_O = 0, V_{inh} = H$			1.5	mA
		$V_{IN} = H, I_O = 0, V_{inh} = H$			6	mA
		$V_{inh} = L$			1	mA
Logic supply current	I_{CC2}	$V_{IN} = L, I_O = 0, V_{inh} = H$		44	60	mA
		$V_{IN} = H, I_O = 0, V_{inh} = H$			22	mA
		$V_{inh} = L$			24	mA
Low-level input voltage	V_{IL}		-0.3		+1.5	V
High-Level Input Voltage	V_{IH}	$V_{CC2} \leq 7\text{ V}$	2.3		V_{CC2}	V
		$V_{CC2} > 7\text{ V}$	2.3		7	V
Low-level input current	I_{IL}	$V_{IN} = L$			± 10	μA
High-level input current	I_{IH}	$V_{IN} = H - 0.3\text{ V}$		30	100	μA
Low-level inhibit voltage	V_{inhL}		-0.3		+1.5	V
High-level inhibit voltage	V_{inhH}	$V_{CC2} \leq 7\text{ V}$	2.3		V_{CC2}	V
		$V_{CC2} > 7\text{ V}$	2.3		7	V
Low-level inhibit current	I_{inhL}		-100	-30		μA
High-level inhibit current	I_{inhH}				± 10	μA
Saturation voltage	$V_{CE(sat)H}$	$I_O = -1\text{ A}$		1.4	1.8	V
	$V_{CE(sat)L}$	$I_O = 1\text{ A}$		1.2	1.8	V
Sensing voltage	V_{SENS}				2	V

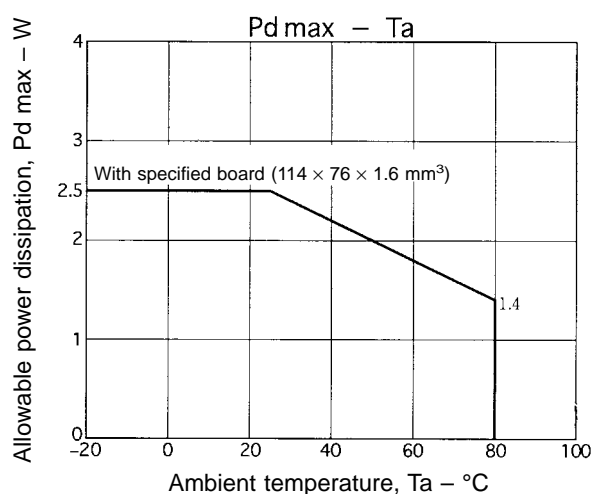

Pin Assignment

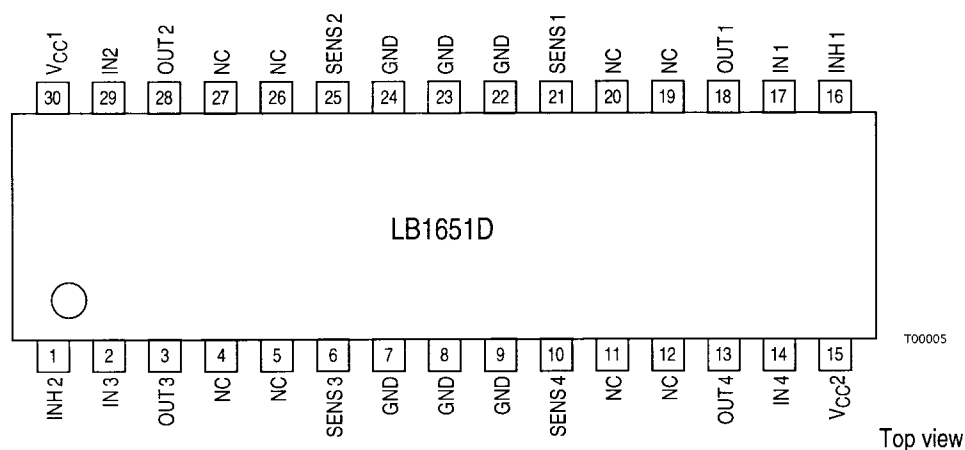

LB1651D

Truth Table

V_{IN} (per CH)	V_{inh}	V_O
H	H	H
L	H	L
H	L	Open*
L	L	Open*

*: High impedance

Sample Application Circuit

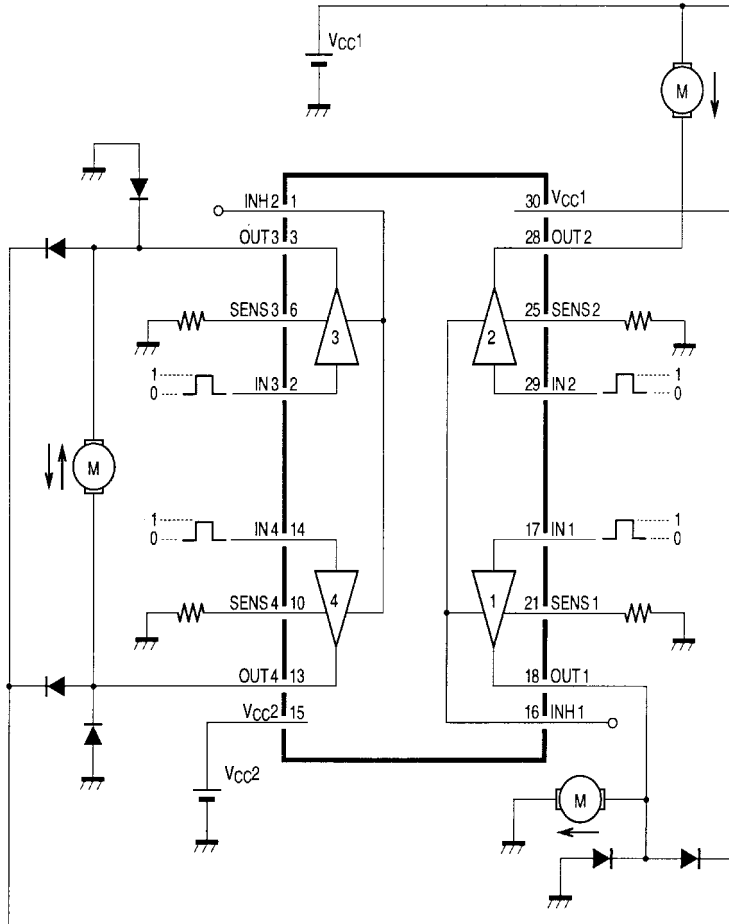

T00006

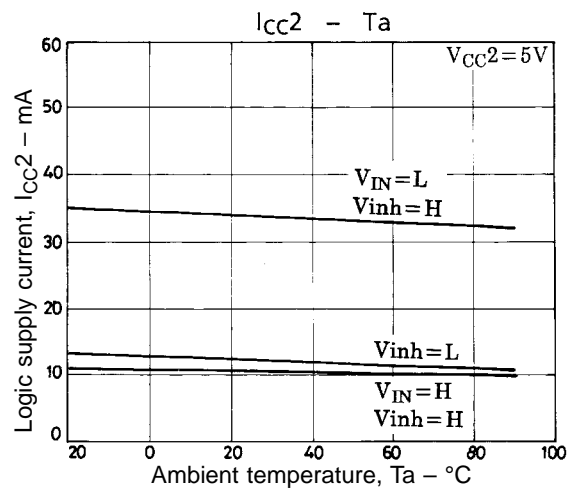
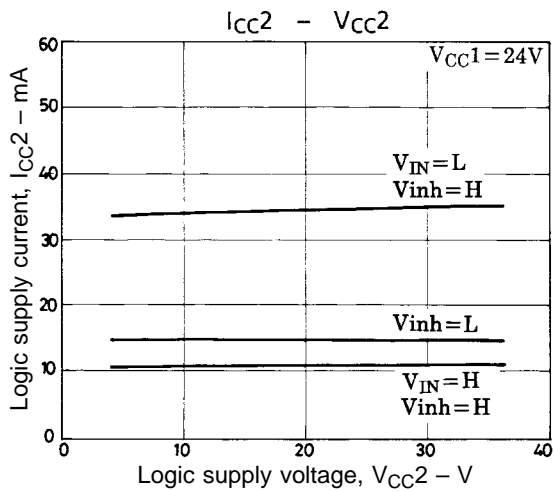

LB1651D

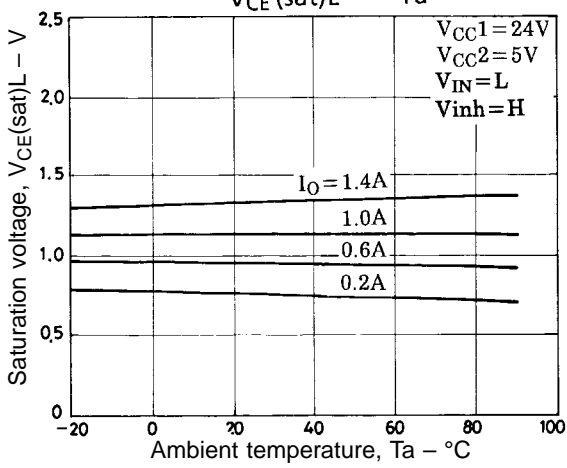
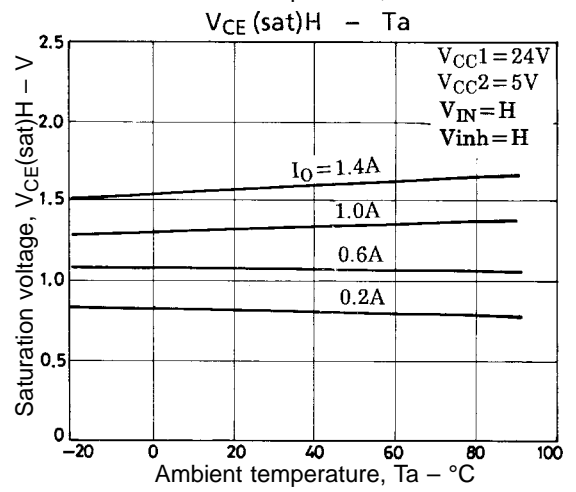
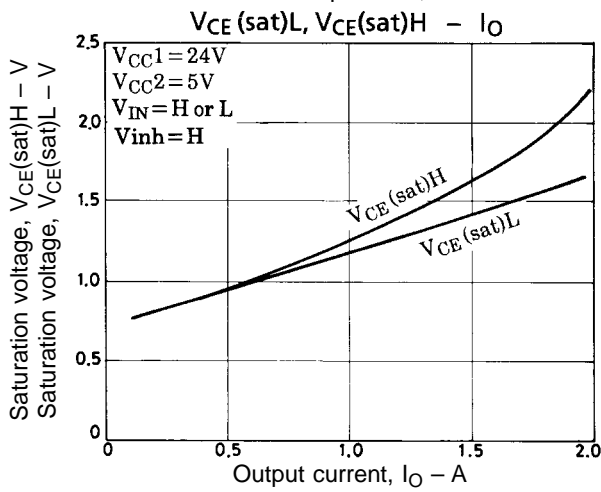
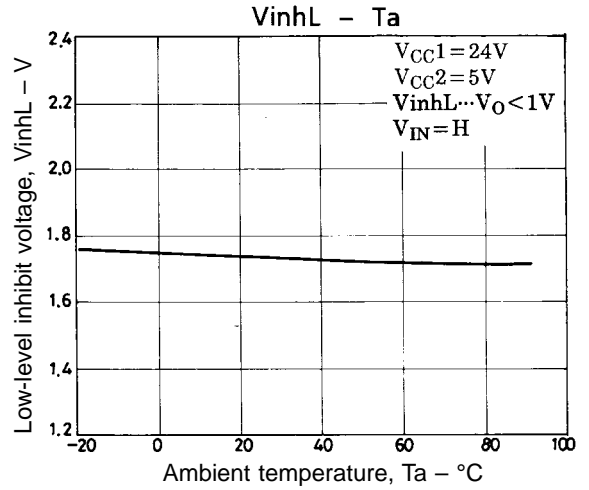
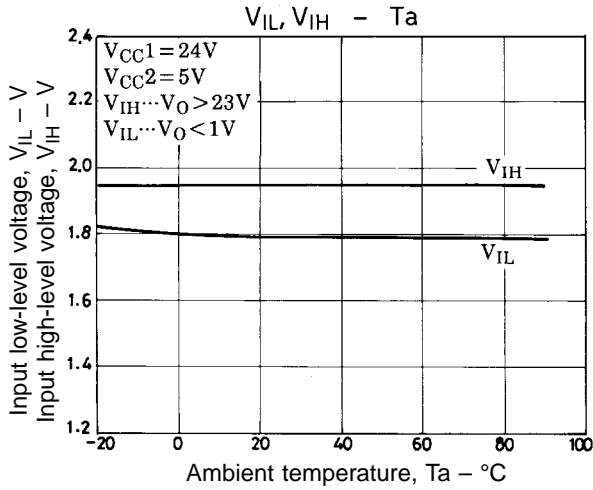

- Specifications of any and all SANYO products described or contained herein stipulate the performance, characteristics, and functions of the described products in the independent state, and are not guarantees of the performance, characteristics, and functions of the described products as mounted in the customer's products or equipment. To verify symptoms and states that cannot be evaluated in an independent device, the customer should always evaluate and test devices mounted in the customer's products or equipment.
- SANYO Electric Co., Ltd. strives to supply high-quality high-reliability products. However, any and all semiconductor products fail with some probability. It is possible that these probabilistic failures could give rise to accidents or events that could endanger human lives, that could give rise to smoke or fire, or that could cause damage to other property. When designing equipment, adopt safety measures so that these kinds of accidents or events cannot occur. Such measures include but are not limited to protective circuits and error prevention circuits for safe design, redundant design, and structural design.
- In the event that any or all SANYO products(including technical data, services) described or contained herein are controlled under any of applicable local export control laws and regulations, such products must not be exported without obtaining the export license from the authorities concerned in accordance with the above law.
- No part of this publication may be reproduced or transmitted in any form or by any means, electronic or mechanical, including photocopying and recording, or any information storage or retrieval system, or otherwise, without the prior written permission of SANYO Electric Co., Ltd.
- Any and all information described or contained herein are subject to change without notice due to product/technology improvement, etc. When designing equipment, refer to the "Delivery Specification" for the SANYO product that you intend to use.
- Information (including circuit diagrams and circuit parameters) herein is for example only ; it is not guaranteed for volume production. SANYO believes information herein is accurate and reliable, but no guarantees are made or implied regarding its use or any infringements of intellectual property rights or other rights of third parties.

This catalog provides information as of April, 1996. Specifications and information herein are subject to change without notice.