



LA8520M

Audio Signal-Processing IC with I/O Switching

Overview

The LA8520M is an I/O switching audio signal-processing IC for use in facsimile units and telephones. It integrates a crosspoint switch, a BTL power amplifier, an electronic volume control, a microphone amplifier, and other functions on a single chip.

Applications

Personal facsimile units and telephones

Functions

- Crosspoint switch (equivalent to an 8 × 8 switch)
- BTL power amplifier
- Electronic volume control
- Serial interface

Features

- Built-in BTL power amplifier (8 to 32 Ω load): $V_{CC} = 5\text{ V}$, $R_L = 16\ \Omega$, $P_{omax} = 250\text{ mW}$
- Electronic volume control (BTL power amplifier

system: seven 4-dB steps, receiver amplifier system: two 3-dB steps)

- Low switching noise, low crosstalk characteristics (crosspoint switch)

Package Dimensions

unit: mm

3129-MFP36SD

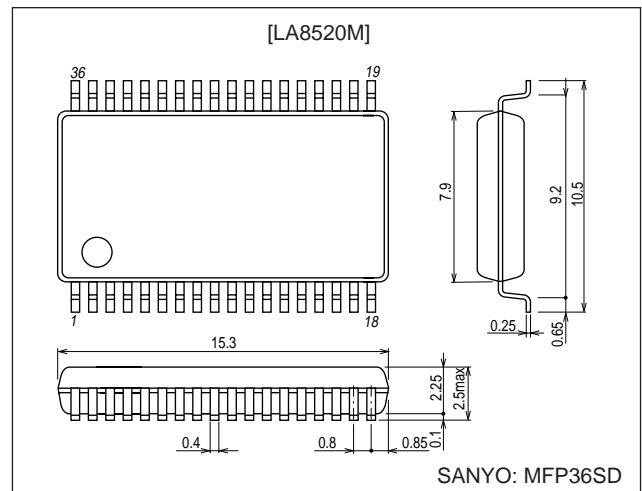

Specifications

Maximum Ratings at $T_a = 25^\circ\text{C}$

Parameter	Symbol	Conditions	Ratings	Unit
Maximum supply voltage	$V_{CC\text{ max}}$		15	V
Allowable power dissipation	$P_{d\text{ max}}$	$T_a \leq 70^\circ\text{C}$ (Mounted on a glass-epoxy board: $114.3 \times 76.1 \times 1.6\text{ mm}^3$)	600	mW
Operating temperature	T_{opr}		-20 to +70	$^\circ\text{C}$
Storage temperature	T_{stg}		-40 to +150	$^\circ\text{C}$

Operating Conditions at $T_a = 25^\circ\text{C}$

Parameter	Symbol	Conditions	Ratings	Unit
Recommended supply voltage	V_{CC}		5	V
Allowable operating supply voltage range	V_{CCop}		4.5 to 7.5	V
	$V_{CCopbtl}$		4.5 to 9.0	V

■ Any and all SANYO products described or contained herein do not have specifications that can handle applications that require extremely high levels of reliability, such as life-support systems, aircraft's control systems, or other applications whose failure can be reasonably expected to result in serious physical and/or material damage. Consult with your SANYO representative nearest you before using any SANYO products described or contained herein in such applications.

■ SANYO assumes no responsibility for equipment failures that result from using products at values that exceed, even momentarily, rated values (such as maximum ratings, operating condition ranges, or other parameters) listed in products specifications of any and all SANYO products described or contained herein.

SANYO Electric Co., Ltd. Semiconductor Business Headquarters

TOKYO OFFICE Tokyo Bldg., 1-10, 1 Chome, Ueno, Taito-ku, TOKYO, 110-8534 JAPAN

LA8520M

Electrical Characteristics at $T_a = 25^\circ\text{C}$, $V_{CC} = 5\text{ V}$, $f_{in} = 1\text{ kHz}$, $R_L = 10\text{ k}\Omega$

Parameter	Symbol	Conditions	Ratings			Unit
			min	typ	max	
Crosspoint switch voltage gain	Gsw	$V_{in} = -13\text{ dBV}$	-2.5	-0.5	1.5	dB
Crosspoint switch maximum input level	Vimax	THD = 1.5 %	-13	-7	—	dBV
Crosspoint switch output noise voltage	Nosw	20 to 20 kHz		15	60	μVrms
Microphone amplifier/TR amplifier voltage gain	Gmic	$V_{in} = -53\text{ dBV}$	38	40	42	dB
Microphone amplifier/TR output distortion	THDmc	$V_{in} = -53\text{ dBV}$	—	0.6	1.5	%
Microphone amplifier/TR equivalent input noise voltage	Nimc	$R_g = 620\ \Omega$, 20 to 20 kHz		2.5	7.5	μVrms
Microphone amplifier/TR maximum voltage gain	Gmax		40	—	—	dB
Receiver amplifier/OGM amplifier voltage gain	Gre	$V_{in} = -33\text{ dBV}$	18	20	22	dB
Receiver amplifier/OGM amplifier output distortion	THDre	$V_{in} = -33\text{ dBV}$		0.4	1.5	%
Operational amplifier voltage gain	Gop	$V_{in} = -13\text{ dBV}$	8	10	12	dB
Operational amplifier output distortion	THDop	$V_{in} = -13\text{ dBV}$	—	0.4	1.5	%
DR amplifier output level	Vodr	$V_{in} = -23\text{ dBV}$, IN(8), OUT(32), sw(10) on	-16.1	-13.6	-11.1	dBV
DR amplifier output distortion	THDdr	$V_{in} = -23\text{ dBV}$, IN(8), OUT(32), sw(10) on		0.5	1.5	%
Handset amplifier output level	Vohd	$V_{in} = -16\text{ dBV}$, IN(9), OUT(34), sw(0B) on	-2	+0.5	+3	dBV
Handset amplifier output distortion	THDhd	$V_{in} = -16\text{ dBV}$, IN(9), OUT(34), sw(0B) on	—	0.55	1.5	%
Handset amplifier attenuator level 1	Att1	address (51)	2.3	3	3.7	dB
Handset amplifier attenuator level 2	Att2	address (52)	3.45	4.15	4.85	dB
Handset amplifier attenuator level 3	Att3	address (53)	5.4	6.1	6.8	dB
Electronic volume control output level	Voivr	$V_{in} = -20\text{ dBV}$, IN(9), OUT(28), sw(2D) on	-22.9	-20.4	-17.9	dBV
Electronic volume control step size	Weivr	$V_{in} = -20\text{ dBV}$, IN(9), OUT(28), sw(2D) on	2.9	3.8	4.6	dB
Electronic volume control output noise voltage	Noivr	20 to 20 kHz, OUT(28)	—	25	60	μVrms
[BTL Power Amplifier]						
Voltage gain	Gpwr	$V_{in} = -20\text{ dBV}$, $R_L = 16\ \Omega$	18.2	19.7	21.2	dB
Total harmonic distortion	THDpw	$V_{in} = -30\text{ dBV}$, $R_L = 16\ \Omega$	—	0.7	1.5	%
Maximum BTL output power	Pomax	THD = 10 %, $R_L = 16\ \Omega$	250	400	—	mW
Ripple rejection ratio	SVRR	$R_g = 620\ \Omega$, $f_{rin} = 100\text{ Hz}$, $V_{rin} = -20\text{ dBV}$, $R_L = 16\ \Omega$	40	50	—	dB
Output noise voltage	Nopw	$R_g = 620\ \Omega$, 20 to 20 kHz, $R_L = 16\ \Omega$	—	20	60	μVrms
[CPU Interface]						
Clock frequency	Fck		—	—	500	kHz
Input signal high level	V_H		3	—	—	V
Input signal low level	V_L		—	—	1.5	V
[V_{REF} and Current Drain]						
Internal reference voltage (the pin 10 voltage)	Vref		2.1	2.25	2.4	V
Quiescent current 1	Icco1	With the BTL power amplifier on and the crosspoint switch off	—	21	29	mA
Quiescent current 2	Icco2	With the BTL power amplifier off and the crosspoint switch off	—	14.5	21	mA

Block Diagram and Application

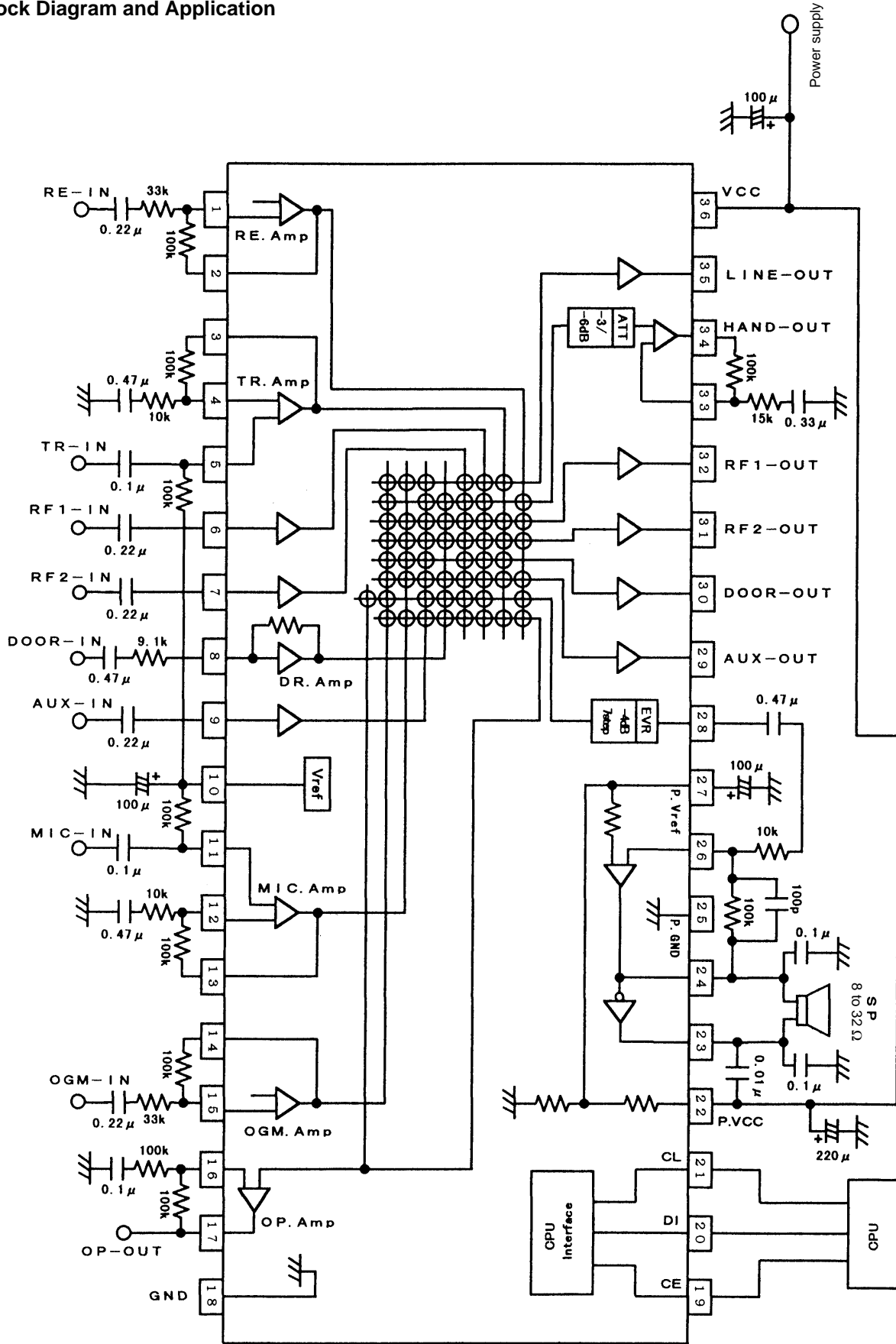

Units (resistance: Ω, capacitance: F)

LA8520M

Test Circuit Diagram

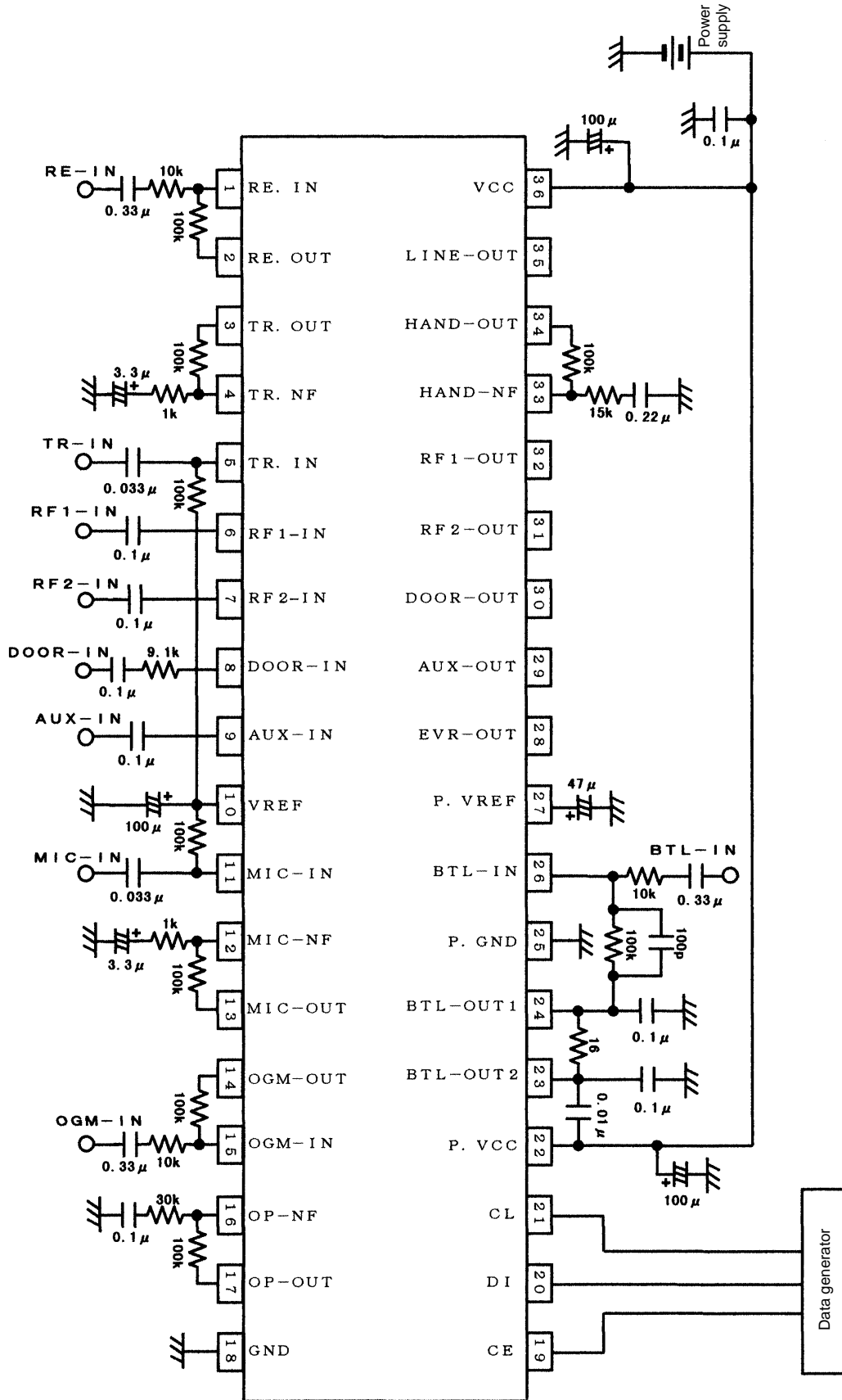

Units (resistance: Ω, capacitance: F)

Serial Data Format

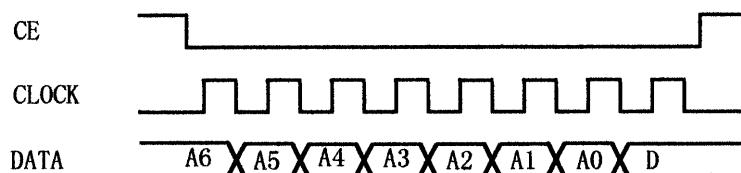

A6 to A0: Setting for the crosspoint switch and control switch address (hexadecimal → binary)

D: Controls the on/off state of the crosspoint switch and control switch.

D = 1: Crosspoint switch on, BTL amplifier on

D = 0: Crosspoint switch off, BTL amplifier off

(The electronic volume control and attenuator can be set to either 0 or 1.)

Address table

Input - Output	LINE	HAND	RF1	RF2	DOOR	AUX	EVR	OP
RE.	—	07	0D	14	—	21	29	2F
TR.	01	—	0E	15	1B	22	—	30
RF1	02	08	38	16	1C	23	2A	31
RF2	03	09	0F	39	1D	24	2B	32
DOOR	—	0A	10	17	—	25	2C	33
AUX	04	0B	11	18	1E	26	2D	34
MIC	05	—	12	19	1F	27	—	35
OGM	06	0C	13	1A	20	28	2E	36
OP	—	—	—	—	—	—	37	—

Other addresses

Address	Mode
00	All crosspoint switches off, default settings for the control switches
3F	BTL power amplifier on (The default state is off.)
40	Electronic volume control 0 dB ← Default setting
41	Electronic volume control -4 dB
42	Electronic volume control -8 dB
43	Electronic volume control -12 dB
44	Electronic volume control -16 dB
45	Electronic volume control -20 dB
46	Electronic volume control -24 dB
47	Electronic volume control -28 dB
50	Handset amplifier attenuator 0 dB ← Default setting
51	Handset amplifier attenuator -3 dB
52	Handset amplifier attenuator -4 dB
53	Handset amplifier attenuator -6 dB

Serial Data Timing

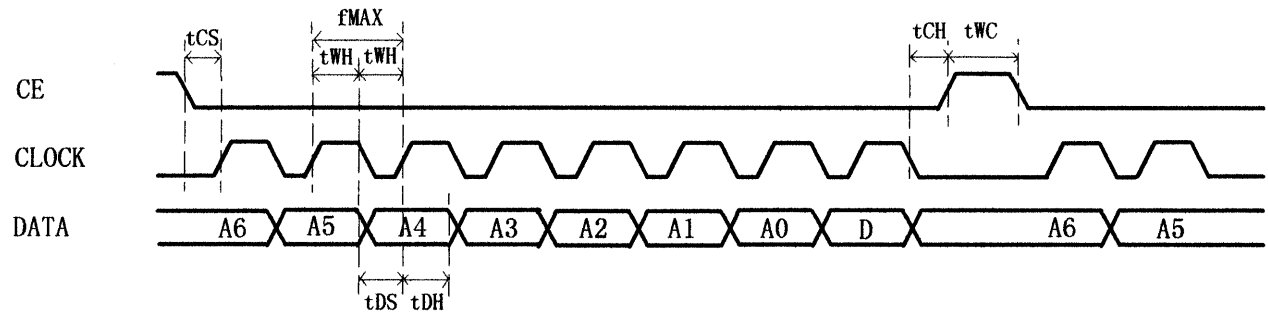

- f_{MAX} (Maximum clock frequency) 500 kHz
- t_{WL} (Low-level clock pulse width) At least 1 μ s
- t_{WH} (High-level clock pulse width) At least 1 μ s
- t_{CS} (Chip enable setup time) At least 1 μ s
- t_{CH} (Chip enable hold time) At least 1 μ s
- t_{DS} (Data setup time) At least 1 μ s
- t_{DH} (Data hold time) At least 1 μ s
- t_{WC} (Chip enable pulse time) At least 1 μ s

Usage Notes

- Microphone and TR amplifiers

Since these two amplifiers are designed for high gain (they support gains up to 40 dB), they cannot be used as buffer amplifiers. Use at lower gains may result in loss of phase margin and oscillation. Therefore, the gain must be set to a value of at least 6 dB.

- Handset amplifier output (pin 34)

A resistor (of at least 150 Ω) must be inserted in series if this output is connected directly to a dynamic speaker.

- BTL power amplifier

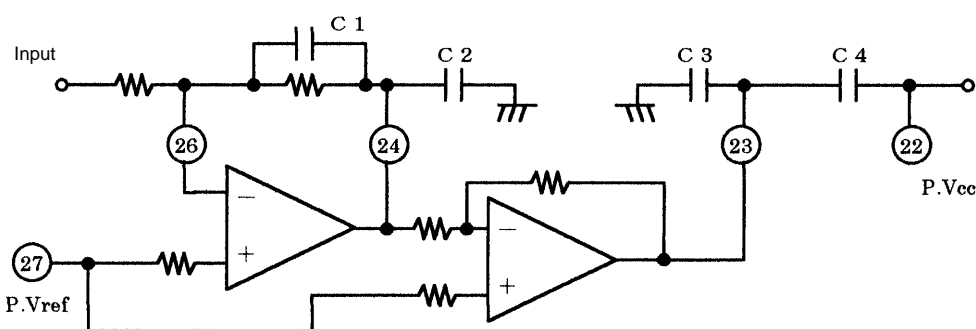

The phase compensation capacitor C4 is not required if the high-frequency noise reduction capacitor C1 is not used. Also, the phase compensation capacitors C2, C3, and C4 should be placed as close as possible to the IC pins, with C2 located the closest.

- Inter-pin shorting

This IC may be damaged or destroyed if power is applied with any pins shorted together. Therefore, when mounting this IC to a printed circuit board always check for pin shorting caused by stray solder or any other foreign material before applying power.

- Load shorting

This IC may be damaged or destroyed if it is operated for extended periods with the load shorted. Do not allow the load to be shorted.

- The slightest fluctuations in operating conditions may cause the ratings to be exceeded if this IC is operated in the vicinity of the maximum ratings. Since this can lead to destruction of the device, applications must be designed with adequate margins with respect to the power-supply voltage and other parameters so that the maximum ratings are never exceeded.

LA8520M

Pin Functions

Unit (resistance: Ω)

Pin No.	Pin	Pin voltage (V)	Notes	Equivalent circuit
1	RE-NF	2.25	RE amplifier noise filter	
2	RE-OUT	2.25	RE amplifier output	
14	OGM-OUT	2.25	OGM amplifier output	
15	OGM-NF	2.25	OGM amplifier noise filter	
16	OP-NF	2.25	Operational amplifier noise filter	
17	OP-OUT	2.25	Operational amplifier output	
3	TR-OUT	2.25	TR amplifier output	
4	TR-NIN	2.25	TR amplifier minus input	
5	TR-PIN	2.25	TR amplifier plus input	
11	MIC-PIN	2.25	Microphone amplifier plus input	
12	MIC-NIN	2.25	Microphone amplifier minus input	
13	MIC-OUT	2.25	Microphone amplifier output	
6	RF1-IN	2.25	RF1 input	
7	RF2-IN	2.25	RF2 input	
9	AUX-IN	2.25	Auxiliary input	
8	DR-IN	2.25	Door phone input	

Continued on next page.

LA8520M

Continued from preceding page.

Unit (resistance: Ω)

Pin No.	Pin	Pin voltage (V)	Notes	Equivalent circuit
10	VREF	2.25	Internal circuit reference voltage (about 2.25 V) • Circuits other than the BTL amplifier operate using this potential as a reference.	
19	CE	V_{CC}	Chip enable input	
20	DI	V_{CC}	Data input	
21	CL	V_{CC}	Clock input	
24	P-OUT1	$0.44 V_{CC}$	BTL power amplifier output 1	
26	P-IN	$0.44 V_{CC}$	BTL power amplifier minus input	
23	P-OUT2	$0.44 V_{CC}$	BTL power amplifier output 2	
27	P-VREF	$0.44 V_{CC}$	BTL power amplifier reference voltage	

Continued on next page.

LA8520M

Continued from preceding page.

Unit (resistance: Ω)

Pin No.	Pin	Pin voltage (V)	Notes	Equivalent circuit
28	VR-OUT	2.25	Electronic volume control output	
29	AUX-OUT	2.25	Auxiliary output	
30	DR-OUT	2.25	Door phone output	
31	RF2-OUT	2.25	RF2 output	
32	RF1-OUT	2.25	RF1 output	
35	LN-OUT	2.25	Line output	
33	HD-NF	2.25	Handset amplifier noise filter	
34	HD-OUT	2.25	Handset amplifier output	
18	GND	—	Ground	
22	P-V _{CC}	5 V applied	Power amplifier power supply	
25	P-GND	—	Power amplifier ground	
36	V _{CC}	5 V applied	Power supply	

Crosspoint Switch Input Dynamic Range Thermal Characteristics

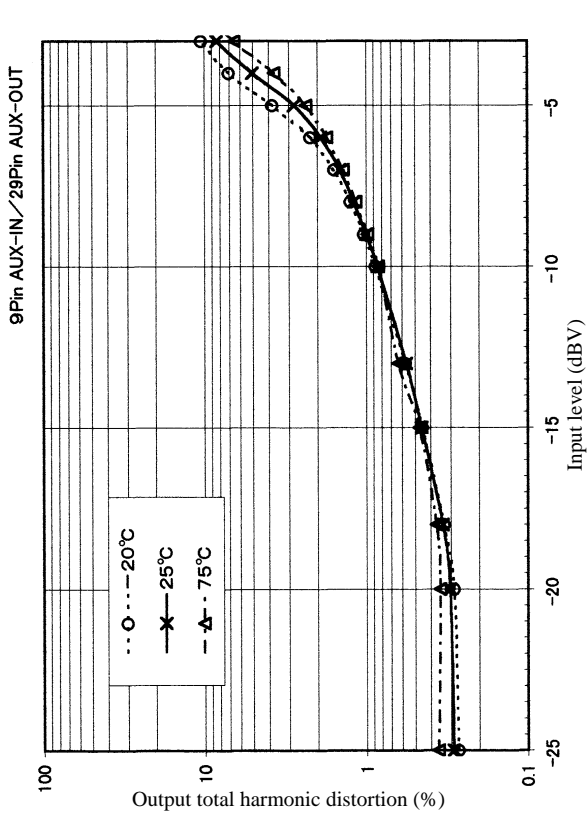

Electronic Volume Control Output Distortion Thermal Characteristics

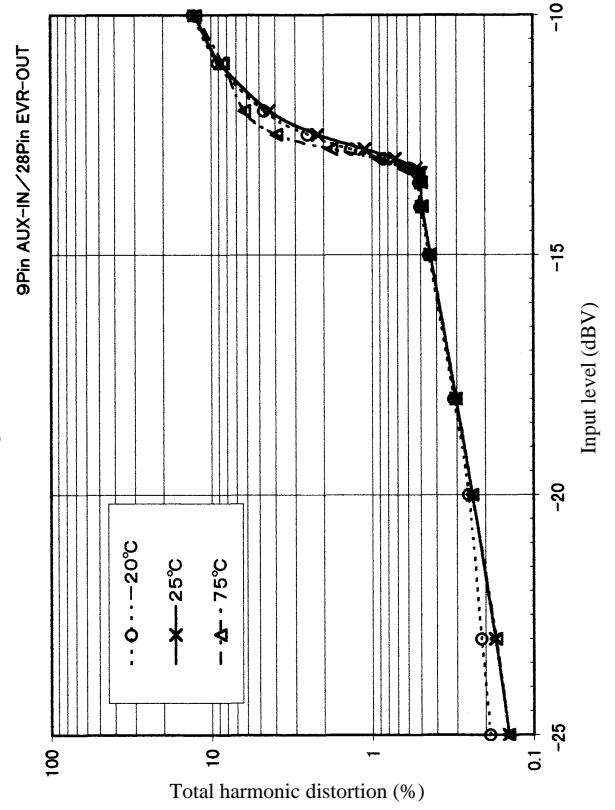

BTL Amplifier Output Distortion Thermal Characteristics

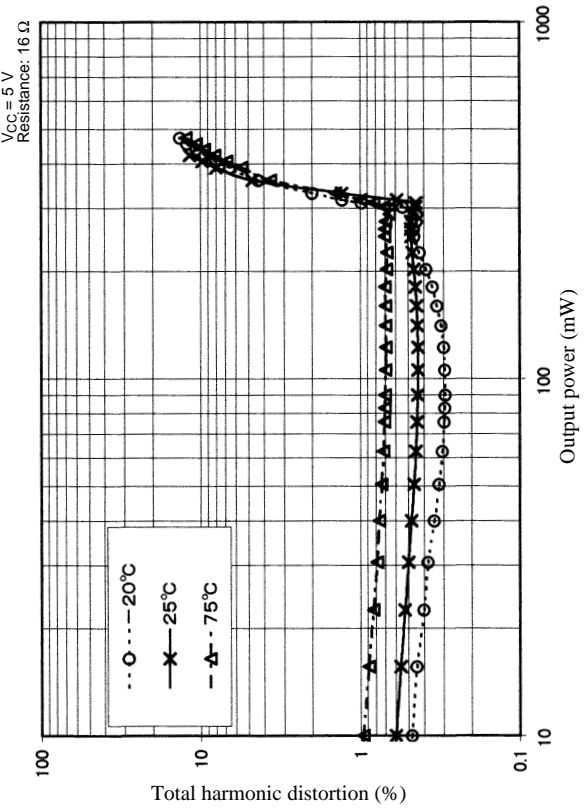

Handset Amplifier Output Distortion Thermal Characteristics

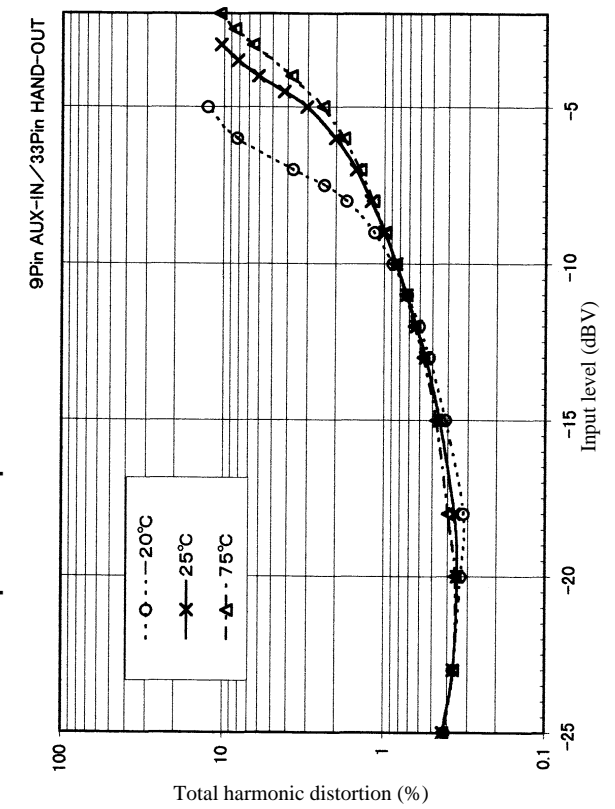

Quiescent Current Thermal Characteristics

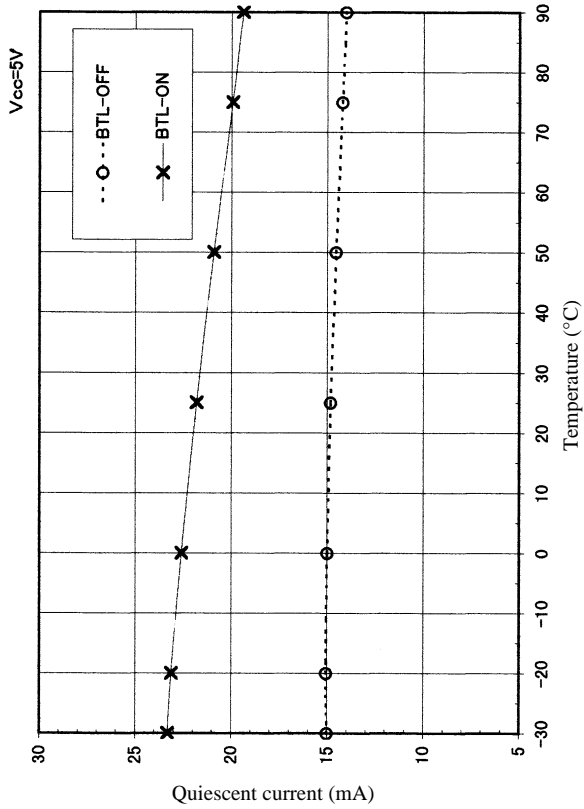

Electronic Volume Control Step Width Thermal Characteristics

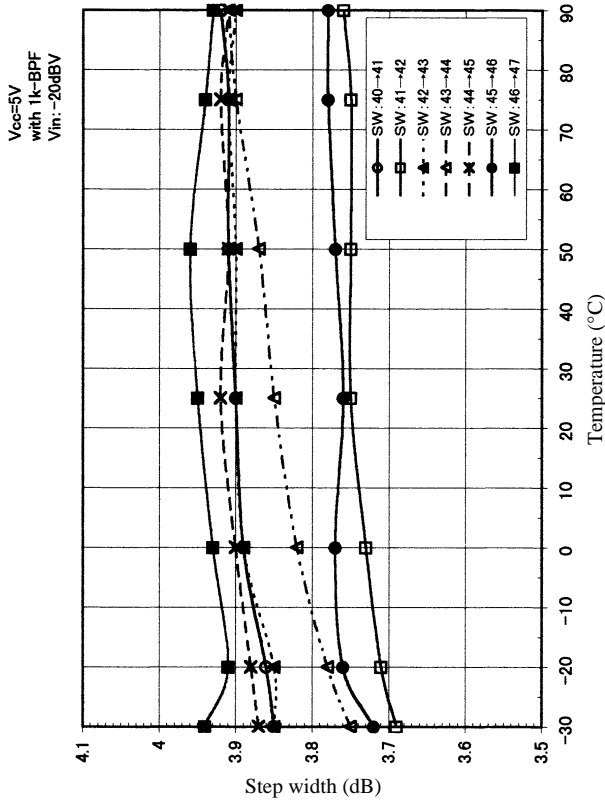

BTL Amplifier Output Distortion Characteristics

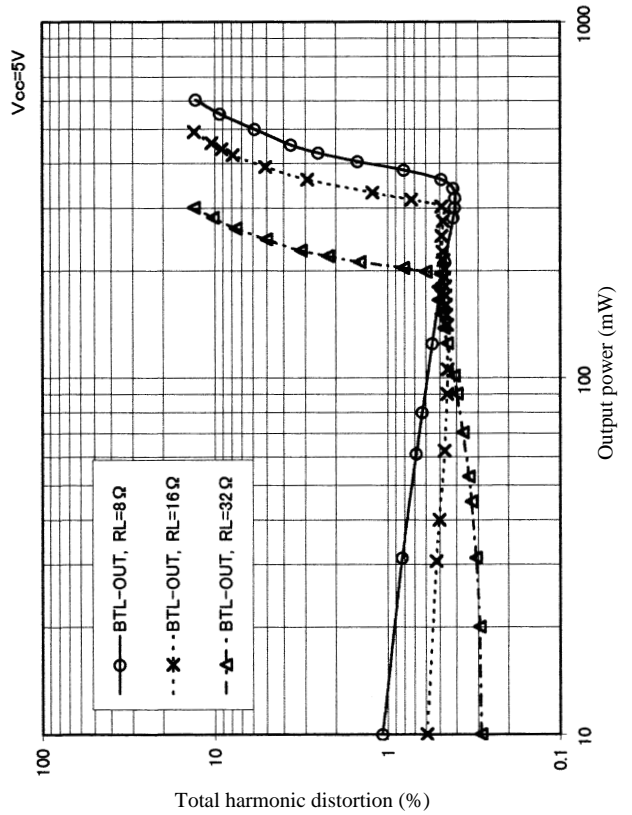

ATT Attenuation Thermal Characteristics

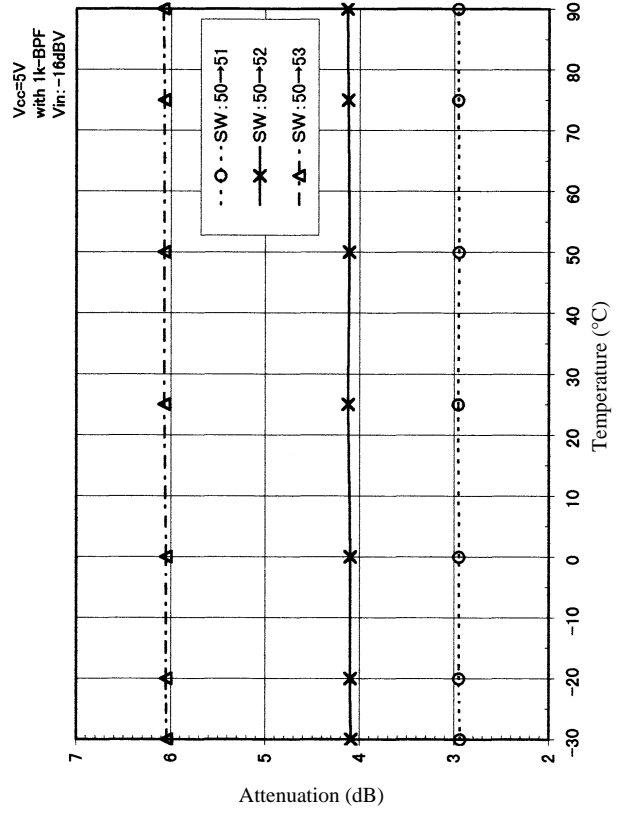

BTL Amplifier Output Distortion Characteristics

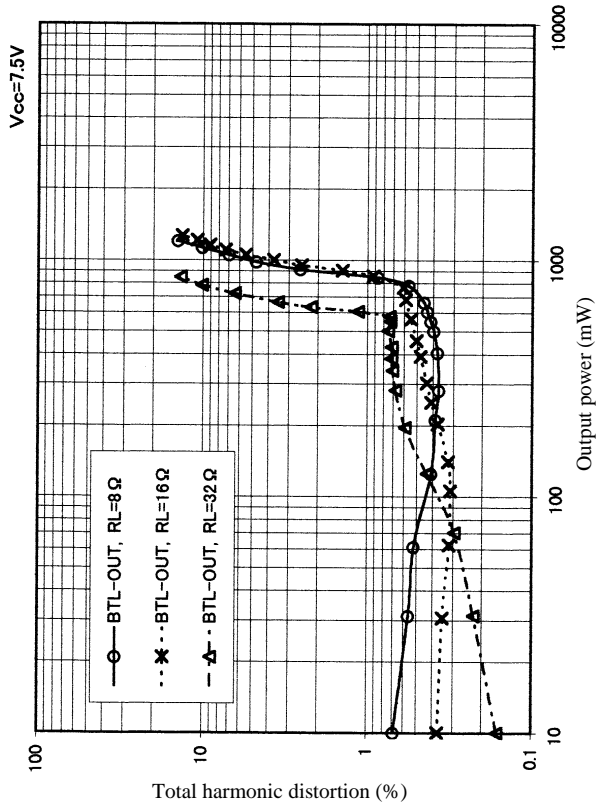

Handset Amplifier Output Distortion Characteristics

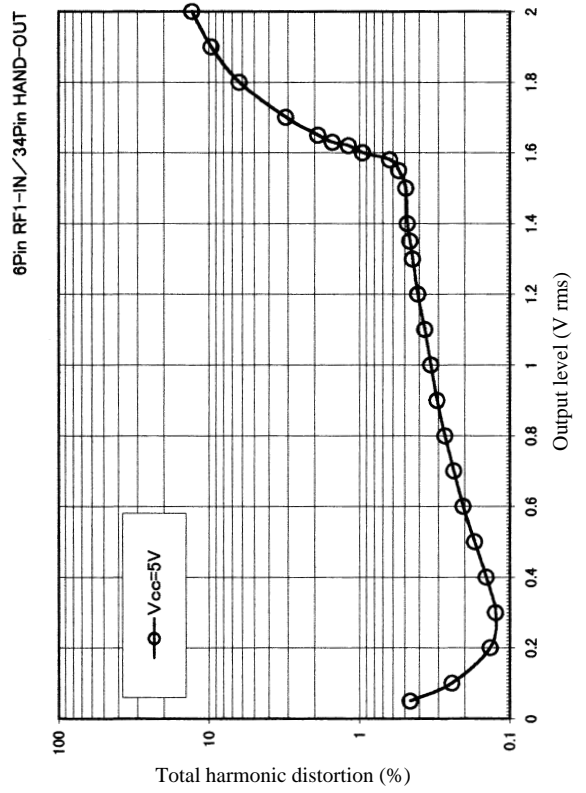

Door Phone Amplifier Output Distortion Characteristics

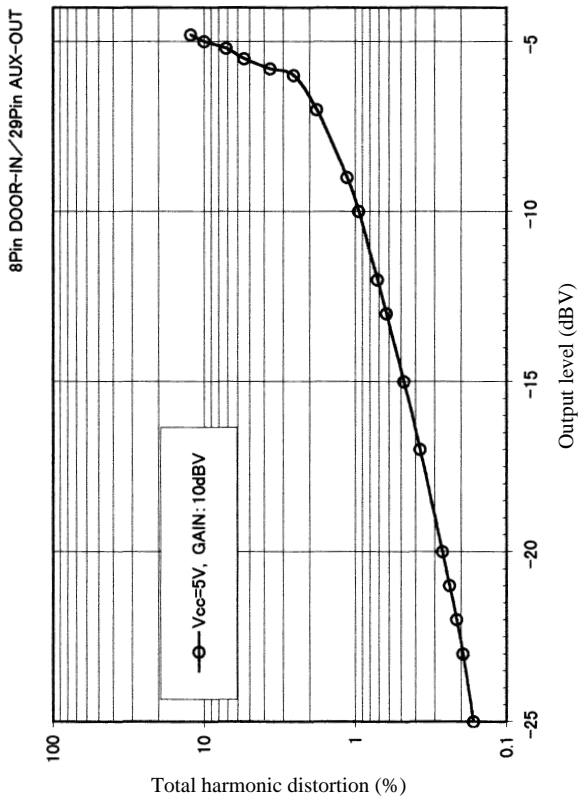

RE Amplifier Output Distortion Characteristics

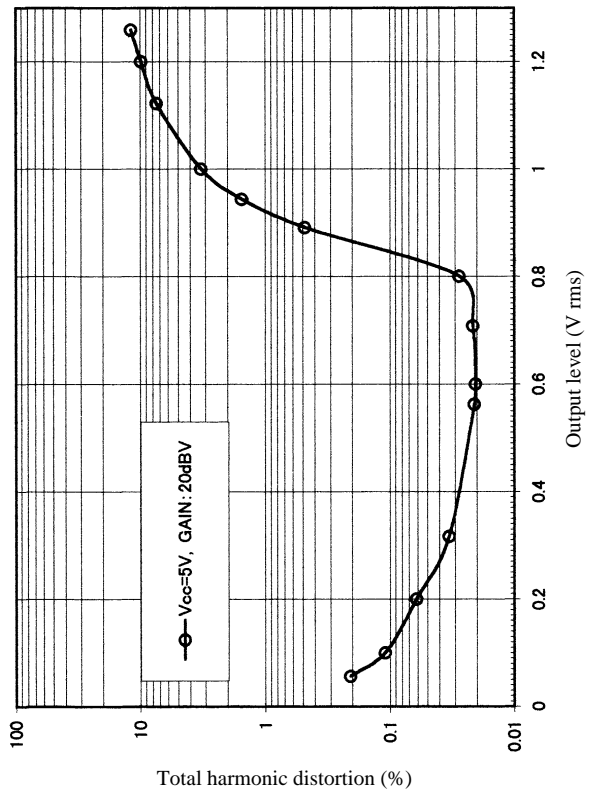

Operational Amplifier Output Distortion Characteristics

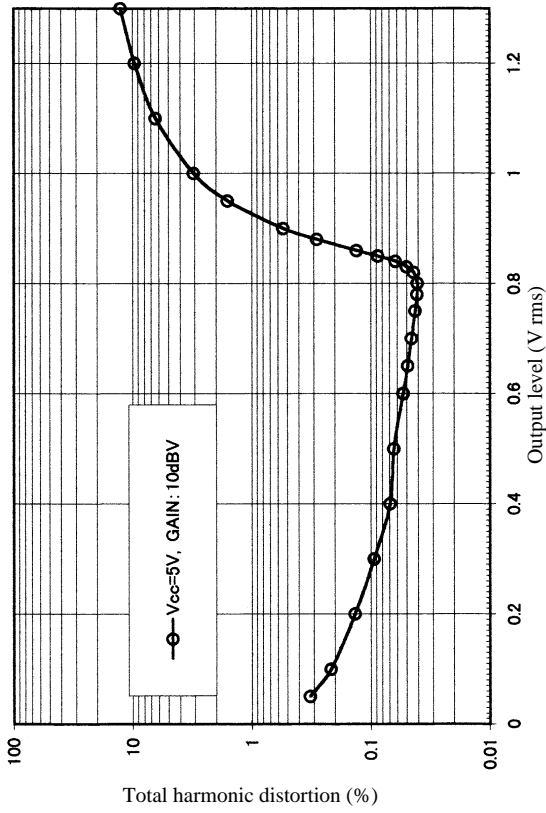

OGM Amplifier Output Distortion Characteristics

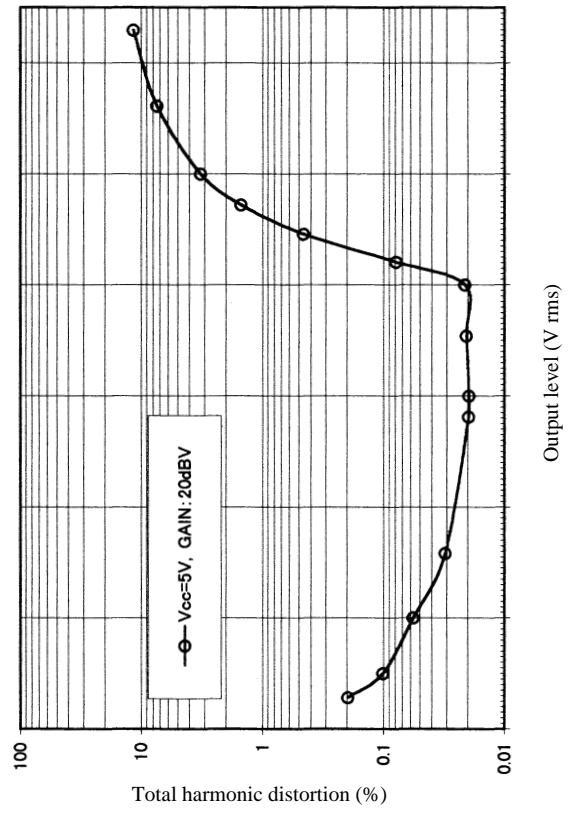

Microphone and TR Amplifiers Output Distortion Characteristics

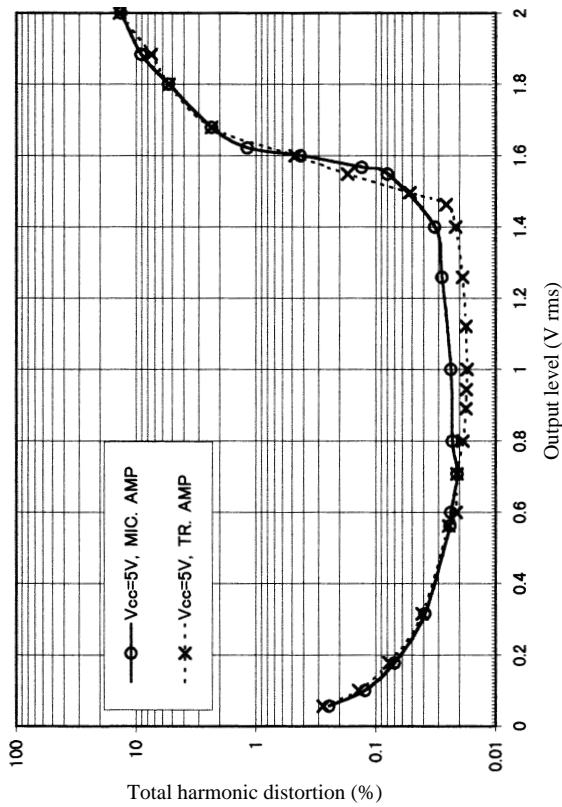

Crosspoint Switch Input Dynamic Range Characteristics

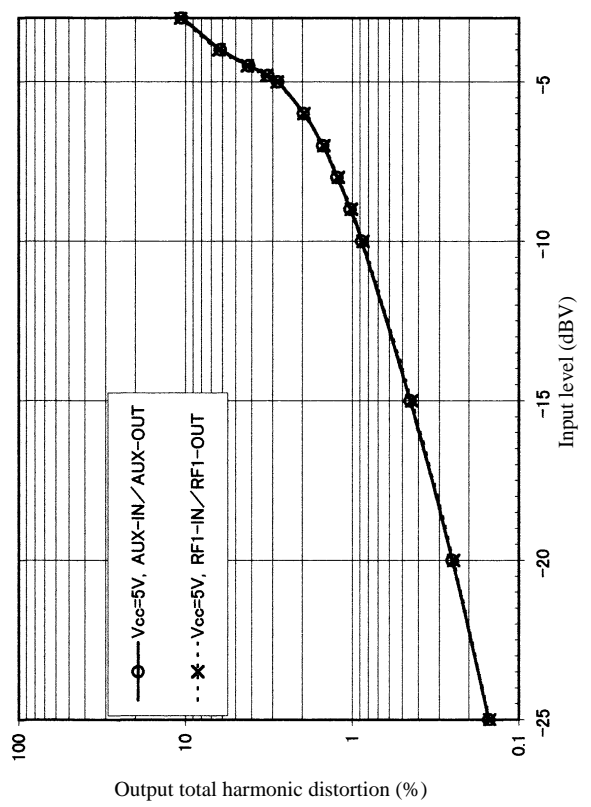

Electronic Volume Control Step Width V_{CC} Dependence

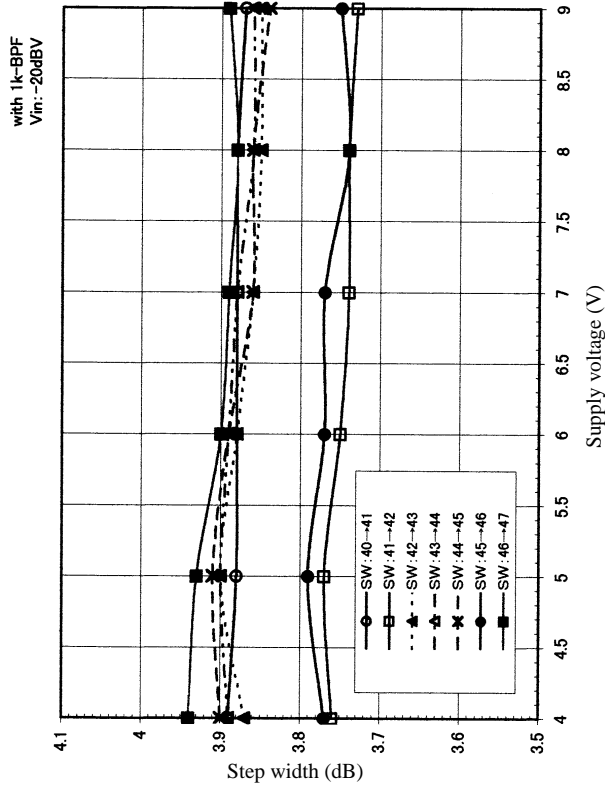

Attenuator Attenuation V_{CC} Dependence

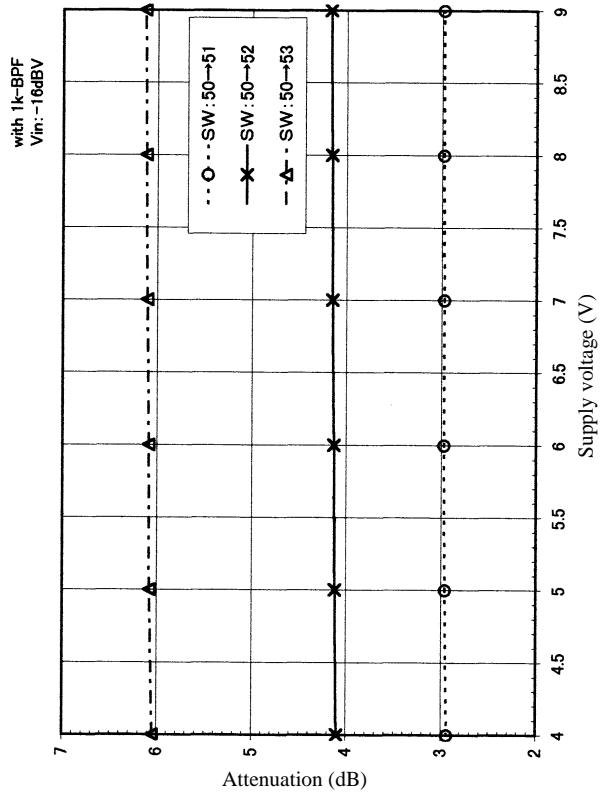

Input Crosstalk Characteristics

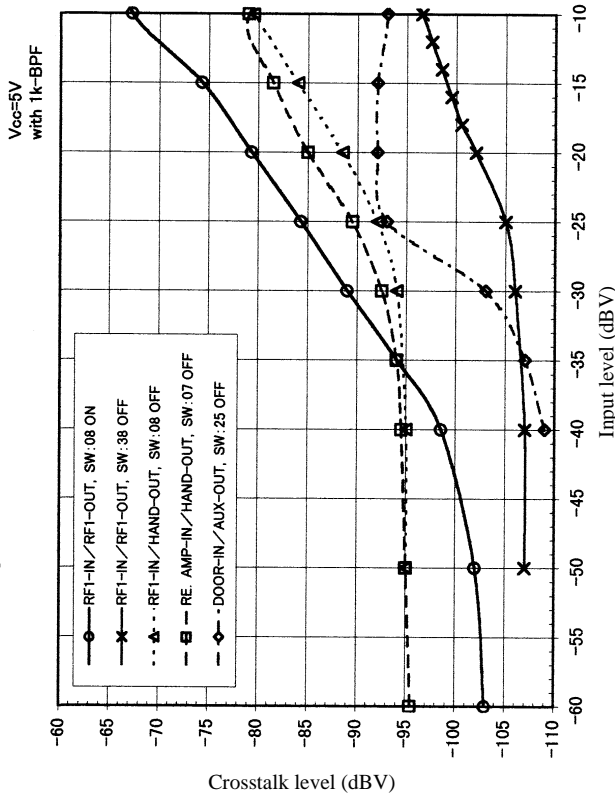

Crosstalk V_{CC} Dependence

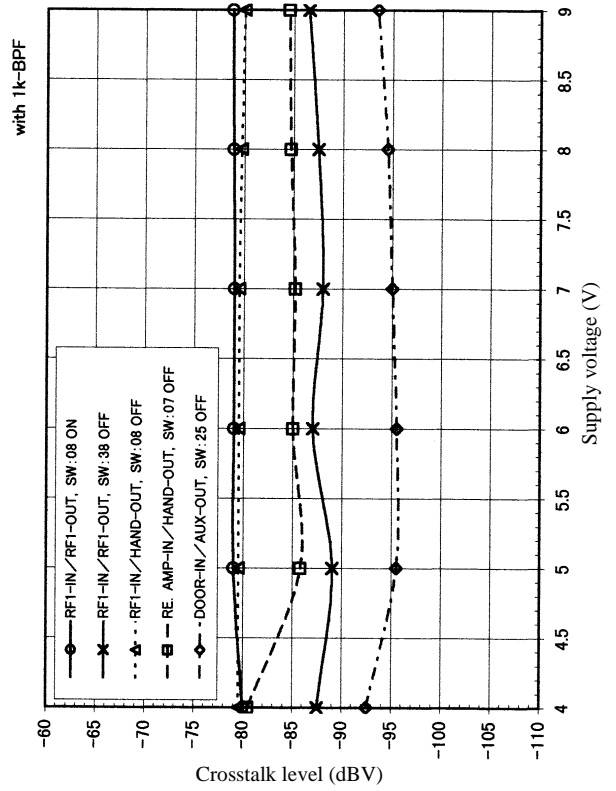

BTL Amplifier Ripple Rejection Ratio V_{CC} Dependence

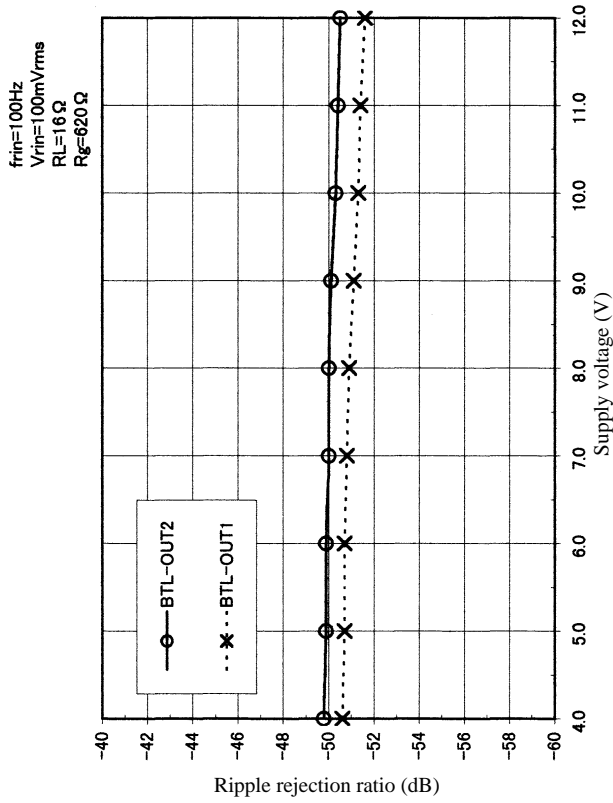

Output Noise V_{CC} Dependence

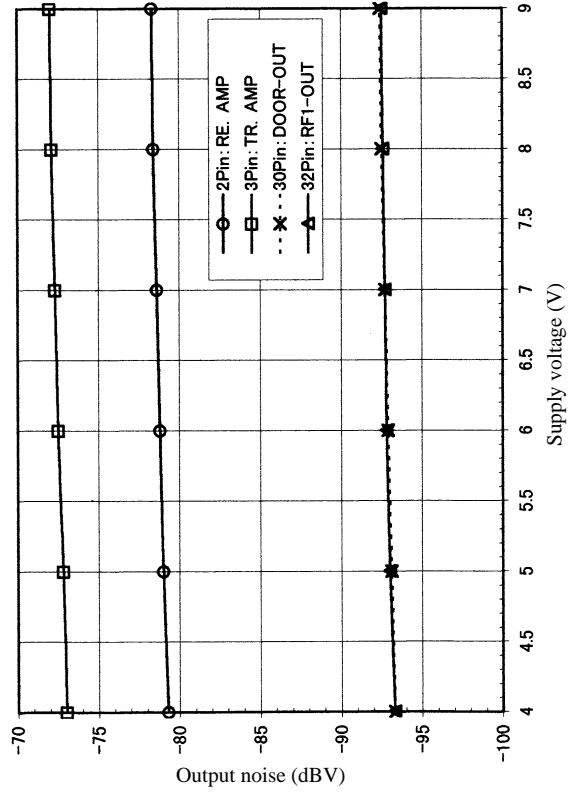

BTL Amplifier Output Noise V_{CC} Dependence

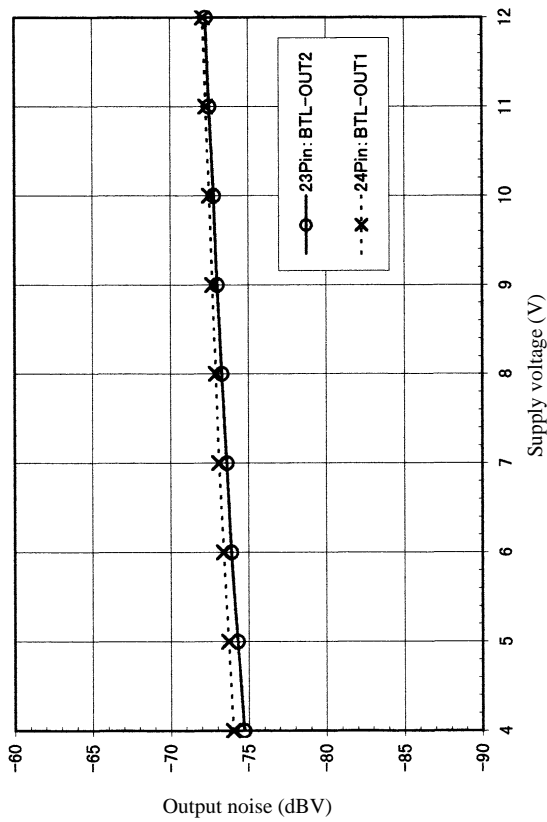

Quiescent Current V_{CC} Dependence

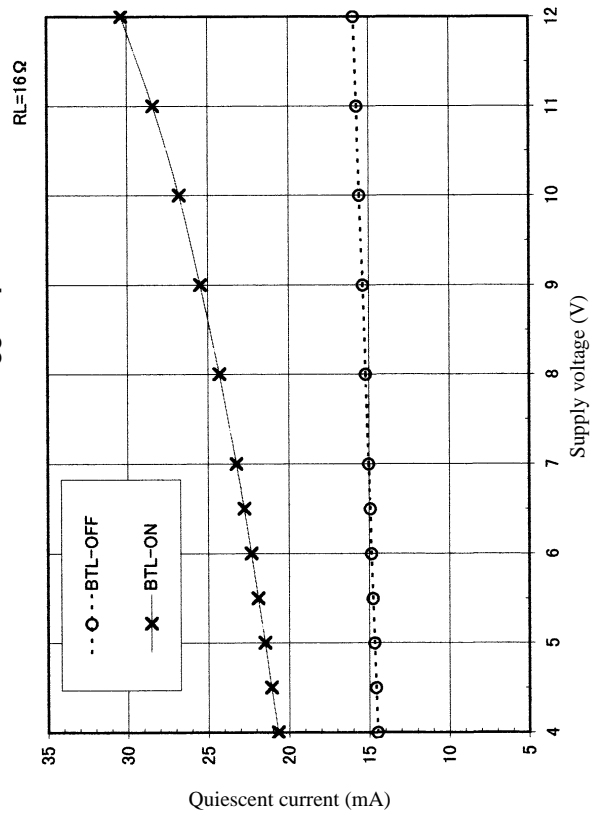

- Specifications of any and all SANYO products described or contained herein stipulate the performance, characteristics, and functions of the described products in the independent state, and are not guarantees of the performance, characteristics, and functions of the described products as mounted in the customer's products or equipment. To verify symptoms and states that cannot be evaluated in an independent device, the customer should always evaluate and test devices mounted in the customer's products or equipment.
- SANYO Electric Co., Ltd. strives to supply high-quality high-reliability products. However, any and all semiconductor products fail with some probability. It is possible that these probabilistic failures could give rise to accidents or events that could endanger human lives, that could give rise to smoke or fire, or that could cause damage to other property. When designing equipment, adopt safety measures so that these kinds of accidents or events cannot occur. Such measures include but are not limited to protective circuits and error prevention circuits for safe design, redundant design, and structural design.
- In the event that any or all SANYO products (including technical data, services) described or contained herein are controlled under any of applicable local export control laws and regulations, such products must not be exported without obtaining the export license from the authorities concerned in accordance with the above law.
- No part of this publication may be reproduced or transmitted in any form or by any means, electronic or mechanical, including photocopying and recording, or any information storage or retrieval system, or otherwise, without the prior written permission of SANYO Electric Co., Ltd.
- Any and all information described or contained herein are subject to change without notice due to product/technology improvement, etc. When designing equipment, refer to the "Delivery Specification" for the SANYO product that you intend to use.
- Information (including circuit diagrams and circuit parameters) herein is for example only; it is not guaranteed for volume production. SANYO believes information herein is accurate and reliable, but no guarantees are made or implied regarding its use or any infringements of intellectual property rights or other rights of third parties.

This catalog provides information as of March, 1999. Specifications and information herein are subject to change without notice.