



# LA1178M

## FM Front End for Car Radio, Home Radio-Use

### Functions

- Double end type mixer
- Oscillator
- Oscillator buffer
- Wide-band AGC circuit
- IF amplifier

### Features

- Excellent intermodulation characteristic (wide-band AGC circuit)
- On-chip local oscillation buffer for electronic tuning.

### Package Dimensions

unit: mm

#### 3086-MFP10

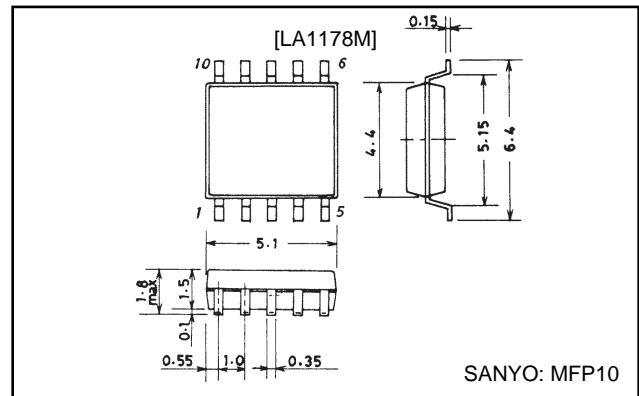

### Specifications

#### Maximum Ratings at Ta=25°C

Parameter	Symbol	Conditions	Ratings	Unit
Maximum supply voltage	V <sub>CC</sub> max	Pins 2, 3, 10	10	V
Allowable power dissipation	P <sub>d</sub> max	T <sub>a</sub> ≤ 75°C	440	mW
Operating temperature	T <sub>opr</sub>		-20 to +70	°C
Storage temperature	T <sub>stg</sub>		-40 to +125	°C

#### Operating Conditions at Ta=25°C

Parameter	Symbol	Conditions	Ratings	Unit
Recommended supply voltage	V <sub>CC</sub>		8	V
Operating voltage range	V <sub>CC</sub> op		8 to 9	V

#### Electrical Characteristics at Ta=25°C, V<sub>CC</sub>=8V, f<sub>im</sub>=88MHz, See specified Test Circuit.

Parameter	Symbol	Conditions	Ratings			Unit
			min	typ	max	
Quiescent current	I <sub>CCO</sub>	No input	21	26	31	mA
AGC high-level voltage	V <sub>AGC-H</sub>	0dBμ, pin 4	7.7	8.0		V
AGC low-level voltage	V <sub>AGC-L</sub>	100dBμ, pin 4		0.07	0.3	V
AGC mixer input	V <sub>IN AGC</sub>	V <sub>AGC</sub> ≤ 2V, Pin 4	67	74	81	dBμ
IF saturation output voltage	V <sub>IF-max</sub>	110dBμ	108	112	116	dBμ
Input limiting voltage	V <sub>lim</sub>		81	88	95	dBμ
Voltage gain	V <sub>G</sub>	65dBμ	84	88	92	dBμ
Local OSC output voltage	V <sub>OSC</sub>	No input, 75Ω termination	80	84	88	dBμ

Note) Extreme caution should be exercised when applying voltage across pin 10 and 3 as dielectric breakdown may occur.

# LA1178M

## Typical Voltage on Each Pin and Pin Description

Pin No.	Typical voltage [V]	Description	Remarks
1	2.7	Mixer input	
2	8.0	Mixer output	
3	8.0	Mixer output	
4	8.0	AGC input	No input
5	2.0	IF amp input	
6	0.0	GND	
7	4.9	Oscillator base terminal	
8	1.4	Oscillation buffer output	
9	4.4	IF output	
10	8.0	VCC	

## Evaluation Circuit and Internal Equivalent Circuit Block Diagram

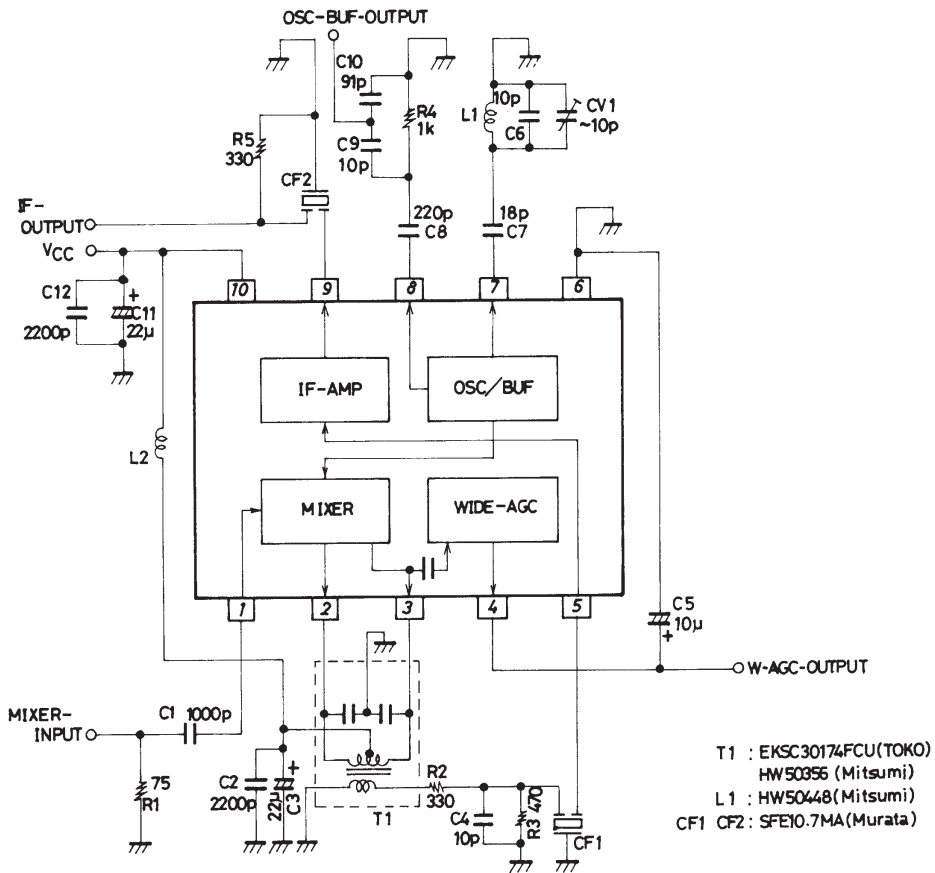

Unit (resistance : Ω, capacitance : F)

# LA1178M

## Pin Description

Pin No.	Function	Internal Equivalent Circuit	Remarks
1	Mixer input		
2	Mixer output		AGC pickup pin is connected.
3	Mixer output		
4	Wide-band AGC output		
5	IF amp input		$R_{IN} \approx 330\Omega$
6	IF amp input		
7	OSC		
8	OSC buffer output		
9	IF amp output		$R_{OUT} \approx 330\Omega$
10	Vcc	Vcc	

# LA1178M

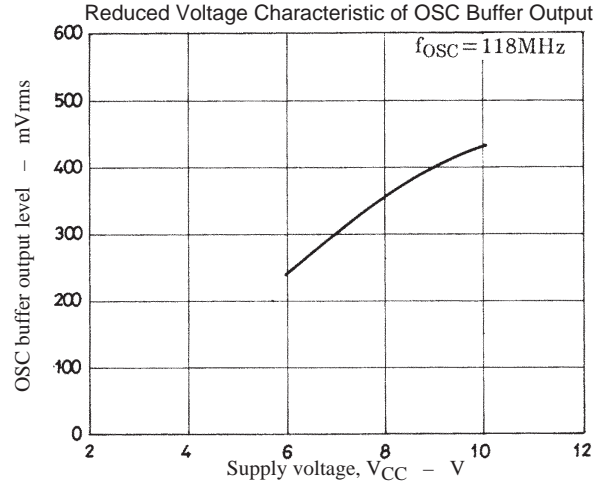
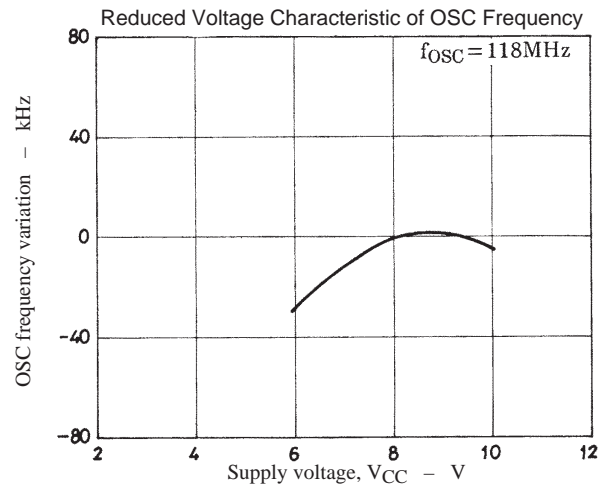
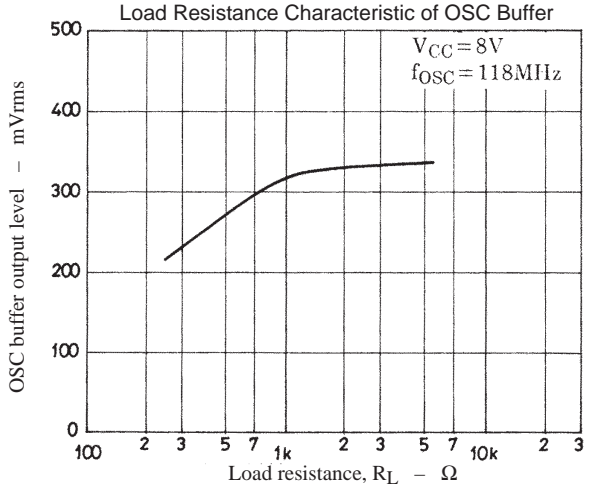
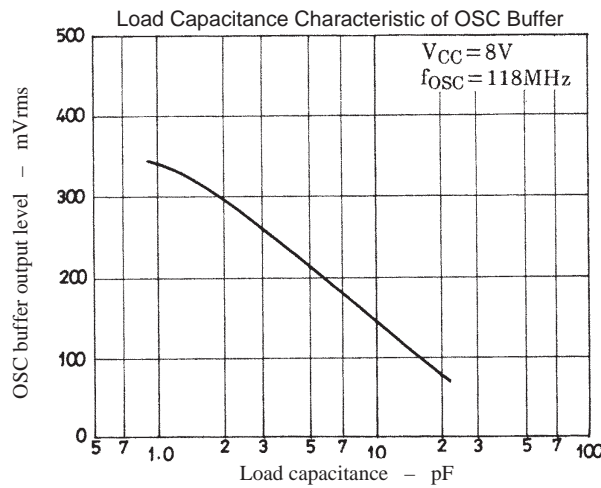
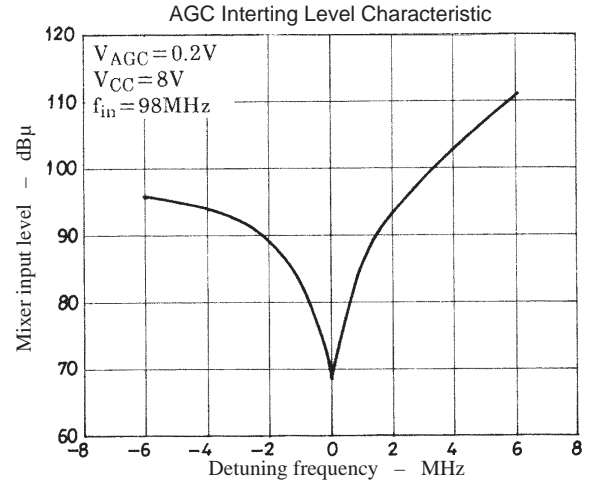
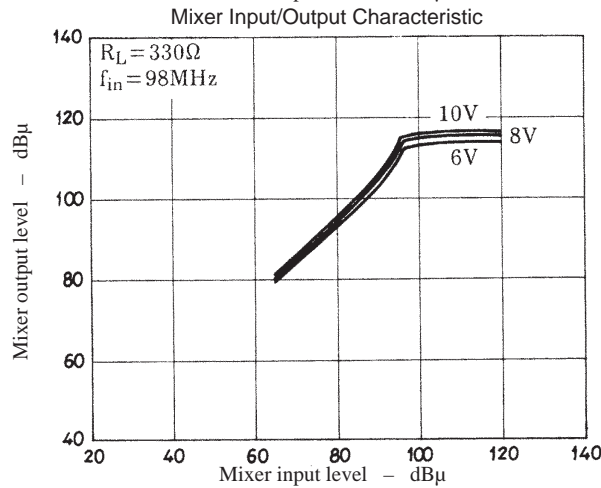
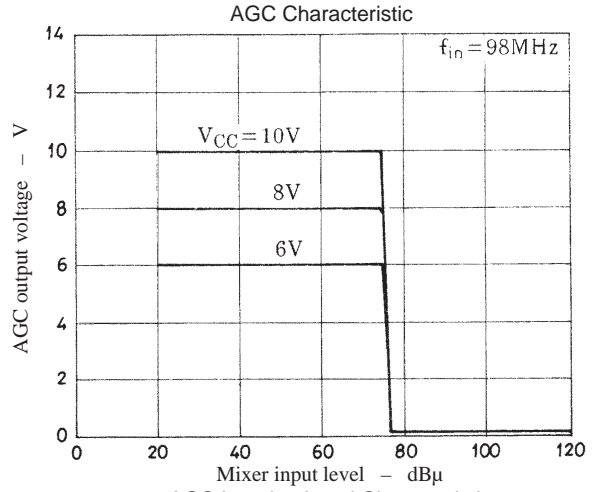
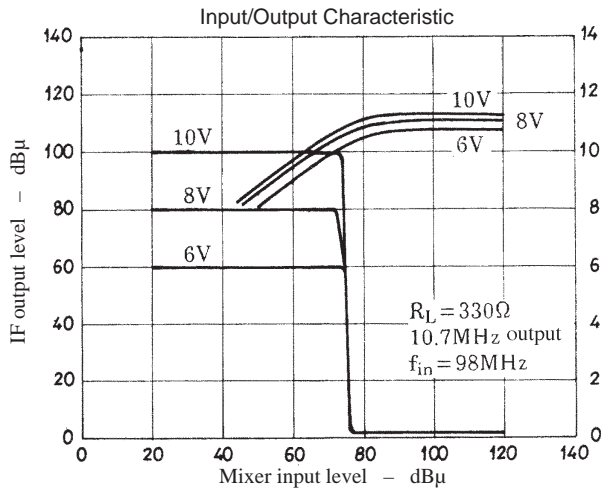

# LA1178M

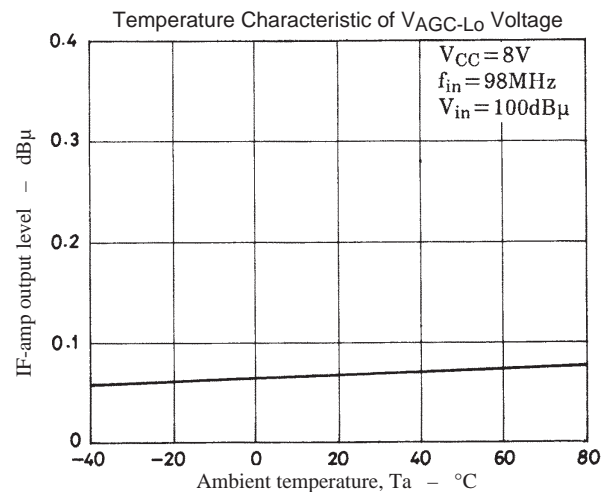
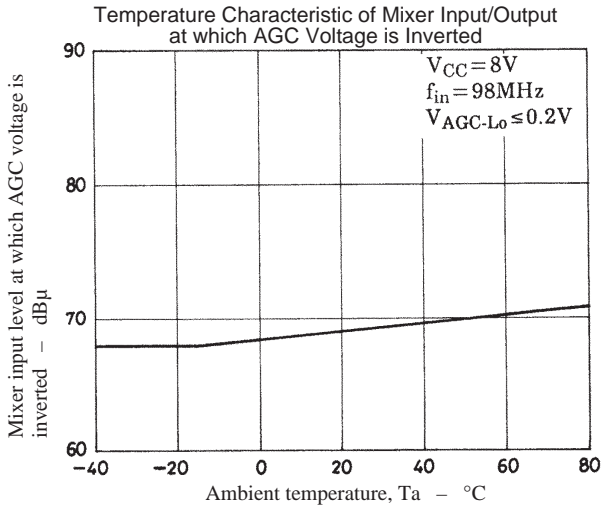
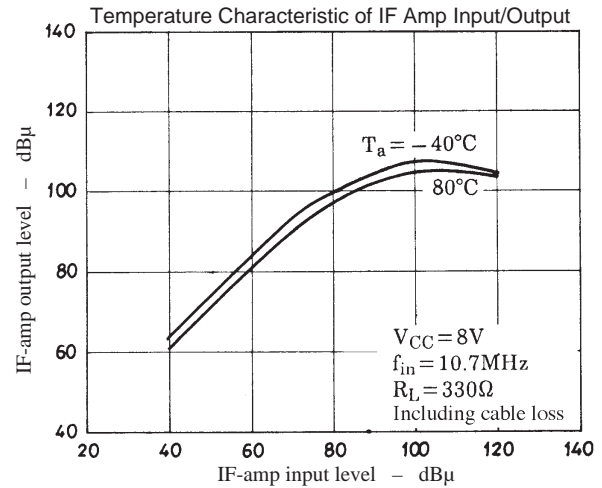
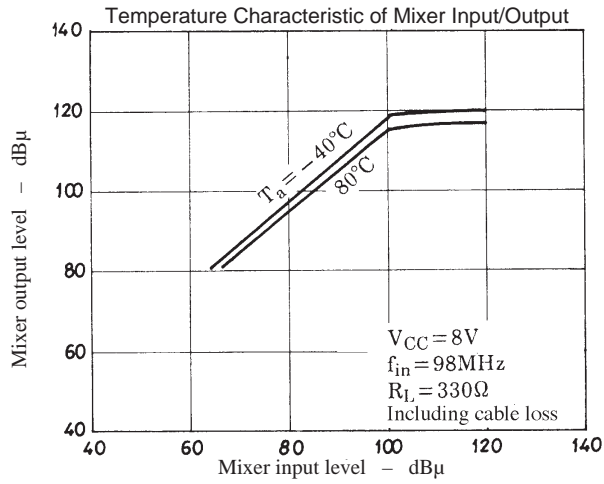
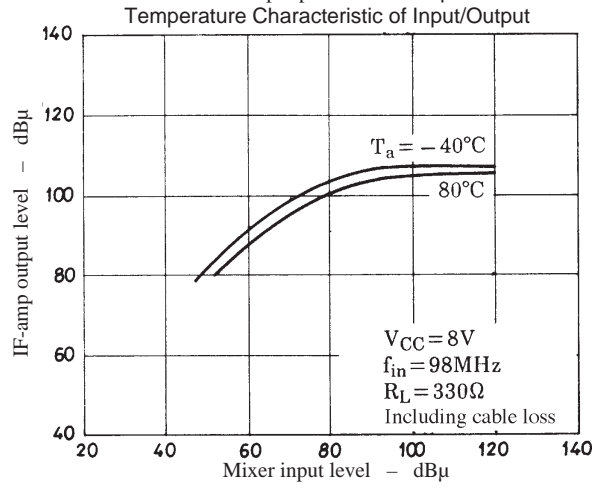
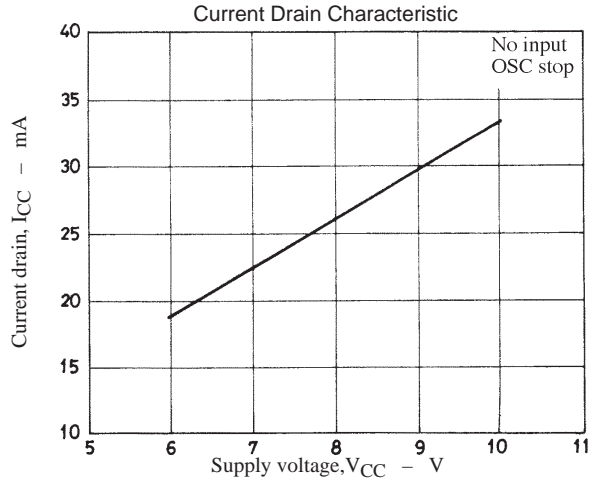
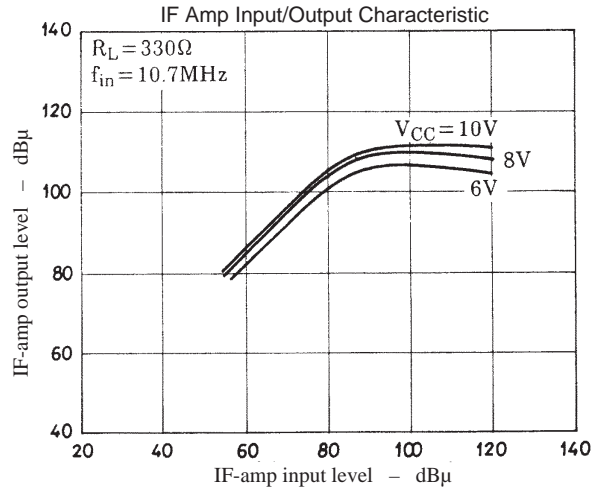
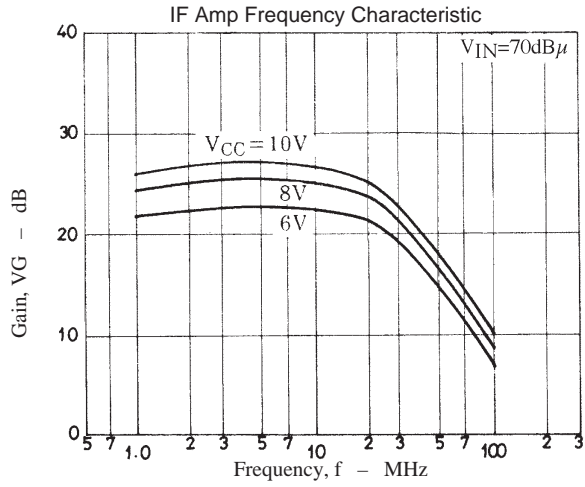

# LA1178M

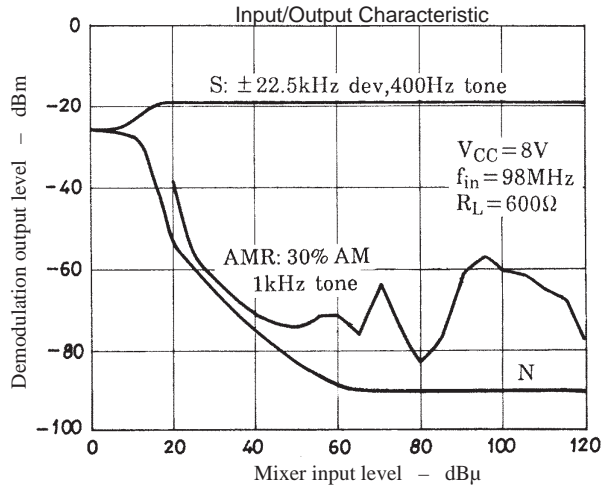
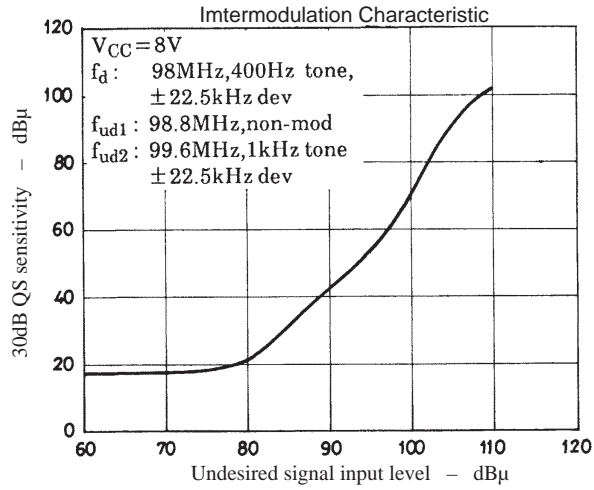
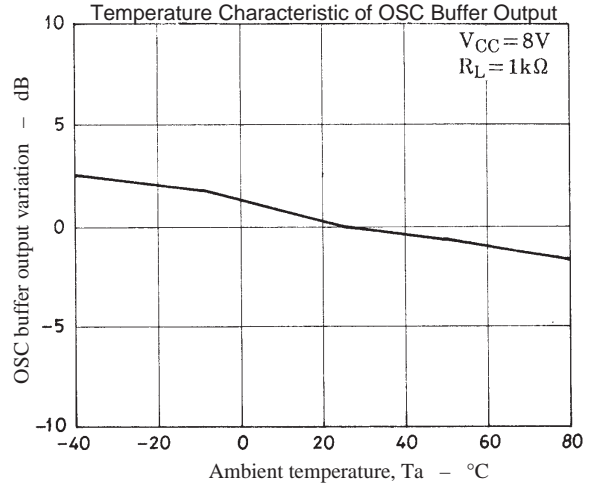
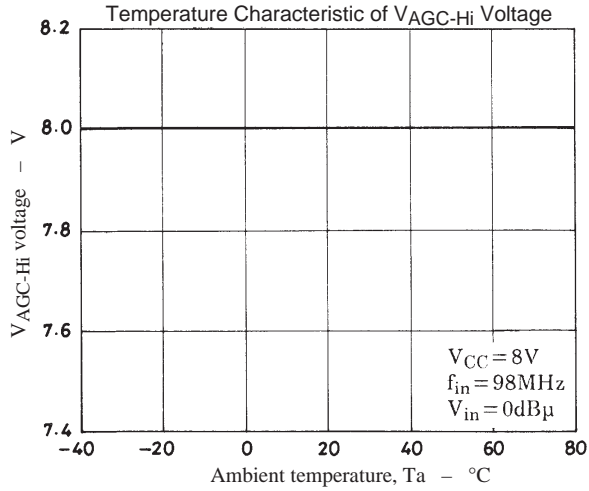

## Smith Chart

$V_{CC} = 8V$

- : LA1178M
- × : LA1175

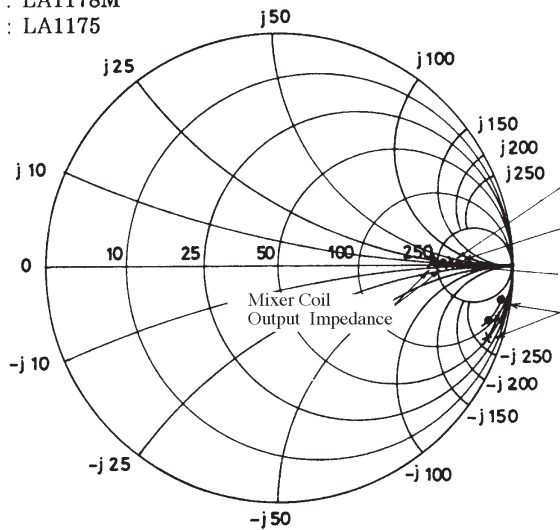

IF AMP  
 Input/Output impedance (LA1175)  
 IF AMP  
 Input impedance (LA1178M)  
 IF AMP  
 Output impedance (LA1178M)  
 Mixer  
 Input impedance :  $f = 80$  to  $110MHz$

}  $f = 10.7MHz$

- No products described or contained herein are intended for use in surgical implants, life-support systems, aerospace equipment, nuclear power control systems, vehicles, disaster/crime-prevention equipment and the like, the failure of which may directly or indirectly cause injury, death or property loss.
- Anyone purchasing any products described or contained herein for an above-mentioned use shall:
  - ① Accept full responsibility and indemnify and defend SANYO ELECTRIC CO., LTD., its affiliates, subsidiaries and distributors and all their officers and employees, jointly and severally, against any and all claims and litigation and all damages, cost and expenses associated with such use:
  - ② Not impose any responsibility for any fault or negligence which may be cited in any such claim or litigation on SANYO ELECTRIC CO., LTD., its affiliates, subsidiaries and distributors or any of their officers and employees jointly or severally.
- Information (including circuit diagrams and circuit parameters) herein is for example only; it is not guaranteed for volume production. SANYO believes information herein is accurate and reliable, but no guarantees are made or implied regarding its use or any infringements of intellectual property rights or other rights of third parties.

This catalog provides information as of September, 1997. Specifications and information herein are subject to change without notice.