



## L88R05 Series

### 5 V, 1 A Voltage-regulator ICs with Reset Function

## Overview

The L88R05 Series is a series of low-saturation voltage regulator ICs that are equipped with a function that generates a reset signal when the power supply for a microcontroller system is turned on or off.

## Applications

- Prevents malfunction when the microcontroller power supply is turned on or off.
- Designed to handle malfunction caused by momentary power interruptions.
- Suited for portable electronic equipment, mobile electronic equipment, and other battery-powered equipment with little capacity to handle fluctuation in input voltage; also suited for equipment with large fluctuations in the primary power supply.

## Functions

- Power supply reset generation function; the reset threshold voltages are ranked.
  - L88R05C:  $V_{RT} = 4.5 \text{ V}$
  - L88R05D:  $V_{RT} = 4.2 \text{ V}$
  - L88R05E:  $V_{RT} = 3.9 \text{ V}$
- 5 V, 1 A output characteristics

## Features

- Minimum I/O voltage difference is small (0.5 V typ.), making power conservation possible, and makes smaller heatsink and transformers possible.
- External capacitor for reset signal output delay time adjustment.
- Sink/source reset output provides compatibility with logic circuitry that has an internal pull-down resistor. Active pull-up facilitates noise suppression.
- Various types of protective circuits on chip (fold back current limiting, thermal protection).
- The package is the TO220-5H; this package facilitates designs for the radiation of heat during the mounting process.

- Any and all SANYO products described or contained herein do not have specifications that can handle applications that require extremely high levels of reliability, such as life-support systems, aircraft's control systems, or other applications whose failure can be reasonably expected to result in serious physical and/or material damage. Consult with your SANYO representative nearest you before using any SANYO products described or contained herein in such applications.
- SANYO assumes no responsibility for equipment failures that result from using products at values that exceed, even momentarily, rated values (such as maximum ratings, operating condition ranges, or other parameters) listed in products specifications of any and all SANYO products described or contained herein.

## Package Dimensions

unit : mm

3079-220-5H

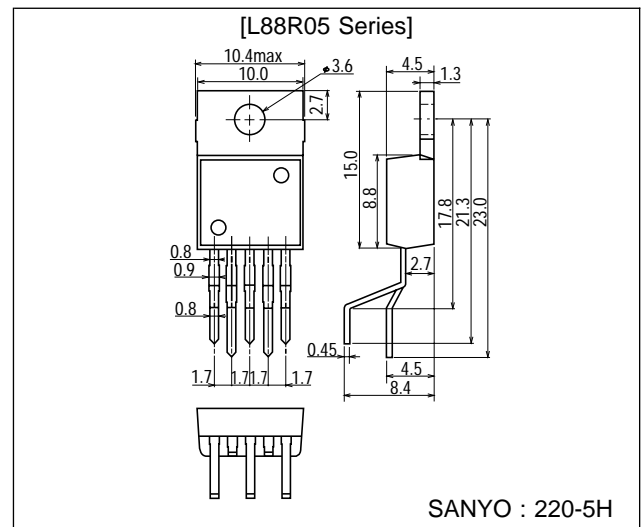

## L88R05 Series

### Specifications

#### Maximum Ratings at $T_a = 25^\circ\text{C}$

Parameter	Symbol	Conditions	Ratings	Unit
Maximum input voltage	$V_{IN\ max}$		18	V
Reset pin voltage	$V_{\overline{RES}}\ max$		18	V
Allowable power dissipation	$Pd\ max$	$T_a \leq 25^\circ\text{C}$ , independent IC	1.75	W
		$T_c \leq 50^\circ\text{C}$ , ideal radiation of heat	20	W
Junction-to-ambient thermal resistance	$\theta_{j-a}$		71.4	$^\circ\text{C/W}$
Junction-to-case thermal resistance	$\theta_{j-c}$		5	$^\circ\text{C/W}$
Operating temperature	$T_{opr}$		-40 to +85	$^\circ\text{C}$
Storage temperature	$T_{stg}$		-55 to +150	$^\circ\text{C}$

#### Operating Conditions at $T_a = 25^\circ\text{C}$

Parameter	Symbol	Conditions	Ratings	Unit
Input voltage	$V_{IN}$		5.6 to 17	V
Output current	$I_{OUT}$		0 to 1	A
Reset output source current	$I_{ORH}$		0 to 200	$\mu\text{A}$
Reset output sink current	$I_{ORL}$		0 to 2	mA

#### Operating Characteristics at $T_j = 25^\circ\text{C}$ , $V_{IN} = 8\text{ V}$ , $I_{OUT} = 1\text{ A}$ , $C_{OUT} = 47\ \mu\text{A}$ for specified circuits

Parameter	Symbol	Condition	min	typ	max	Unit
[Power Supply]						
Output voltage	$V_{OUT}$		4.85	5.0	5.15	V
Dropout voltage	$V_{DROP1}$			0.5	1.0	V
	$V_{DROP2}$	$I_{OUT} = 300\text{ mA}$		0.25	0.50	V
Line regulation	$\Delta V_{OLN}$	$5.6\text{ V} \leq V_{IN} \leq 17\text{ V}$		10	70	mV
Load regulation	$\Delta V_{OLD}$	$5\text{ mA} \leq I_{OUT} \leq 1\text{ A}$		50	150	mV
Peak output current	$I_{OP}$		1	1.8		A
Output short-circuit current	$I_{OSC}$			0.3	1.2	A
Current drain	$I_{Q1}$	$I_{OUT} = 0$		2.1	4	mA
	$I_{Q2}$			32	80	mA
Output noise voltage	$V_{NO}$	$10\text{ Hz} \leq f \leq 100\text{ kHz}$		70		$\mu\text{Vrms}$
Output voltage temperature coefficient	$\Delta V_o/\Delta T_a$	$T_j = 25\text{ to }125^\circ\text{C}$		-0.5		$\text{mV}/^\circ\text{C}$
Ripple rejection ratio	$R_{rej}$	$f = 120\text{ Hz}$ , $6\text{ V} \leq V_{IN} \leq 17\text{ V}$		60		dB
[Reset]						
High-level reset output voltage	$V_{ORH}$	$I_{ORH} = 200\ \mu\text{A}$ , CD open	4.83	4.98	5.13	V
Low-level reset output voltage	$V_{ORL}$	$I_{ORL} = 2\text{ mA}$ , CD grounded		100	200	mV
Reset threshold voltage	$V_{RT}$	C-rank	4.3	4.5	4.7	V
		D-rank	4.0	4.2	4.4	V
		E-rank	3.7	3.9	4.1	V
Reset hysteresis voltage	$V_{hys}$		50	100	200	mV
Output delay time	$t_d$	$C_d = 0.1\ \mu\text{F}$	7.5	10	12.5	ms

### Pin Assignments

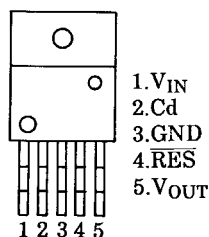

Top view

# L88R05 Series

## Equivalent Circuit Block Diagram

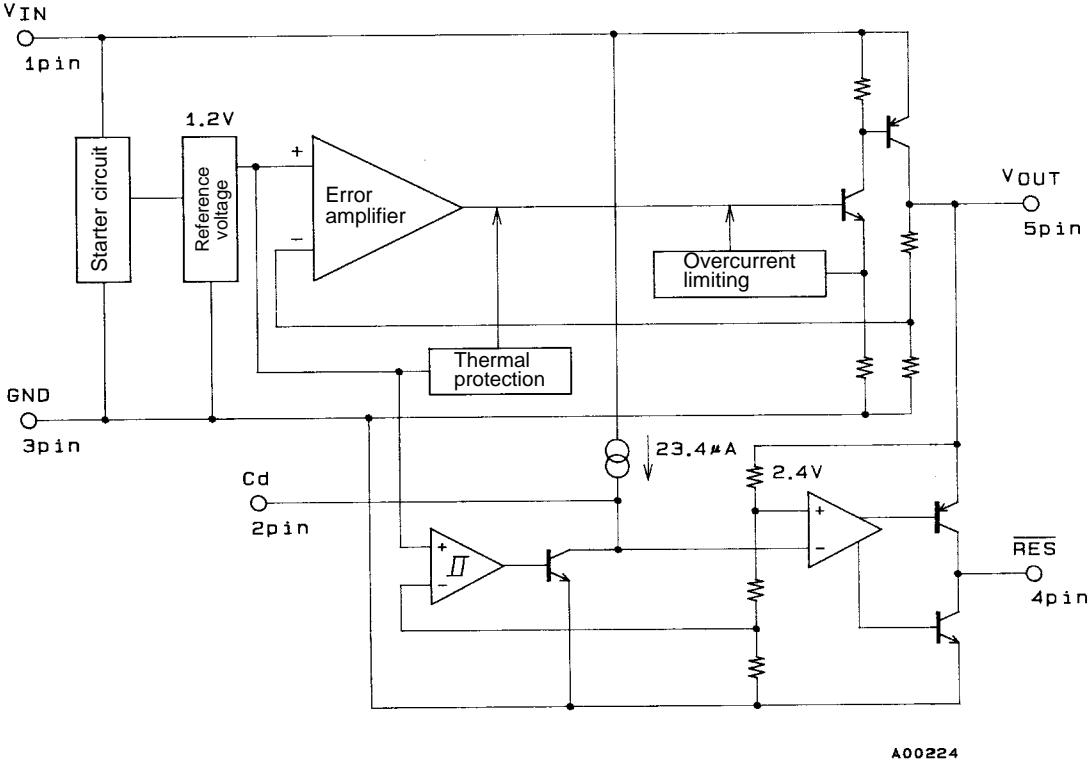

## Measurement Circuit

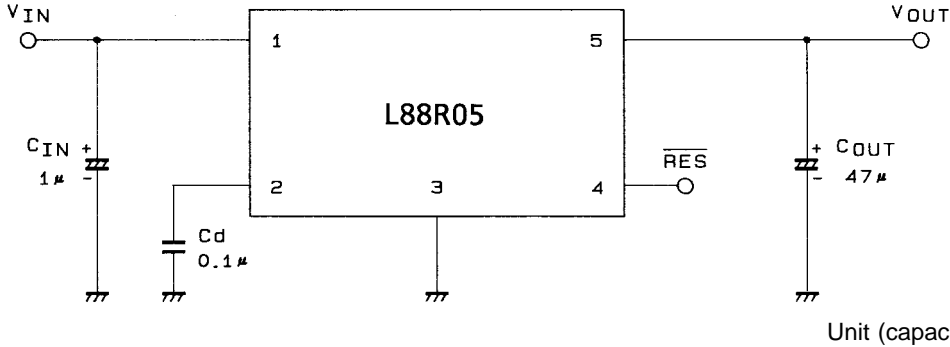

A00225

Sample Application Circuit

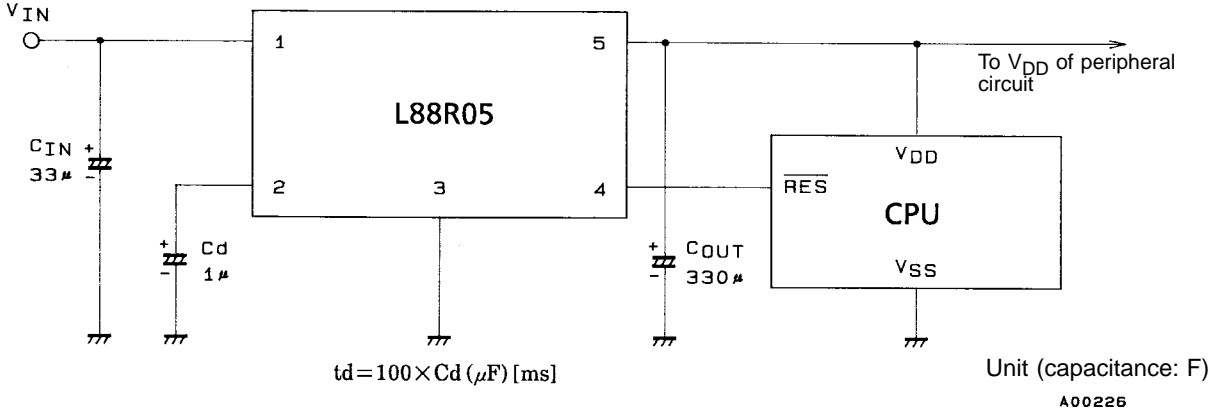

Notes:

1. Set  $C_{OUT}$  to be 47  $\mu F$  or greater and select it according to the applications.
2. Use the capacitors for  $C_{OUT}$  and  $C_d$  with high-temperature stability.

L88R05C's Reset Operation

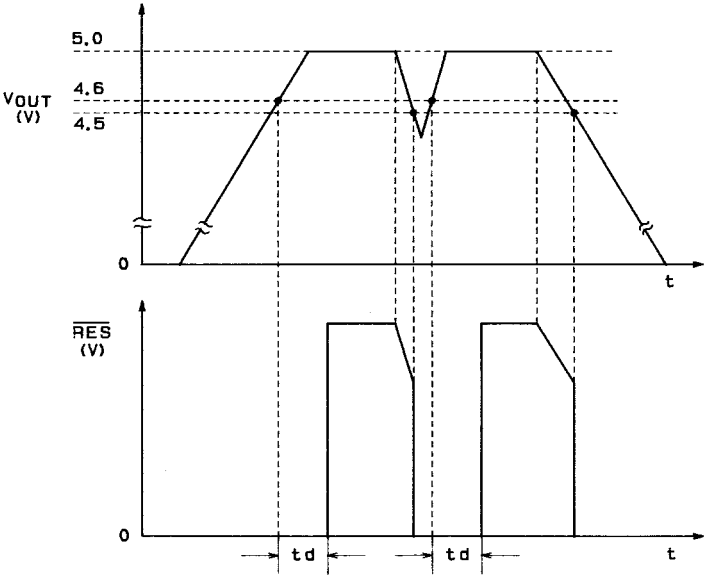

# L88R05 Series

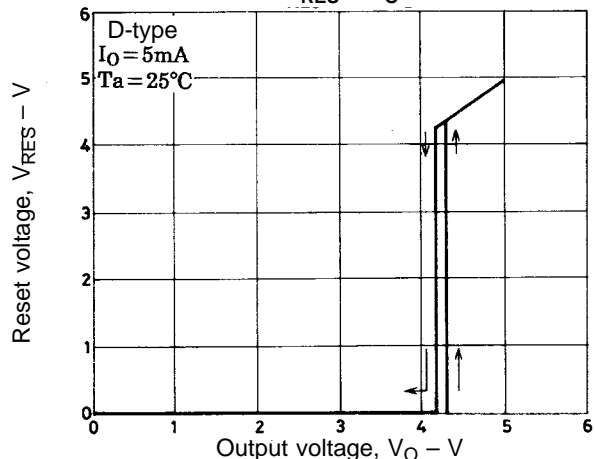
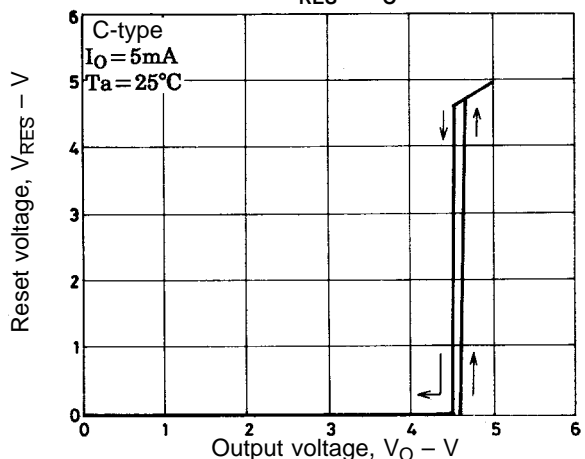
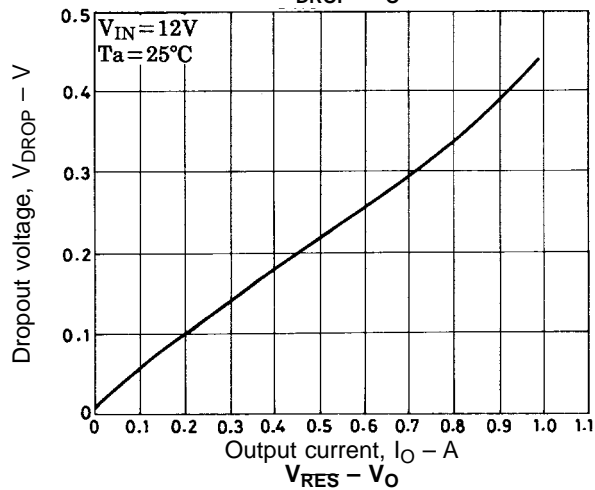
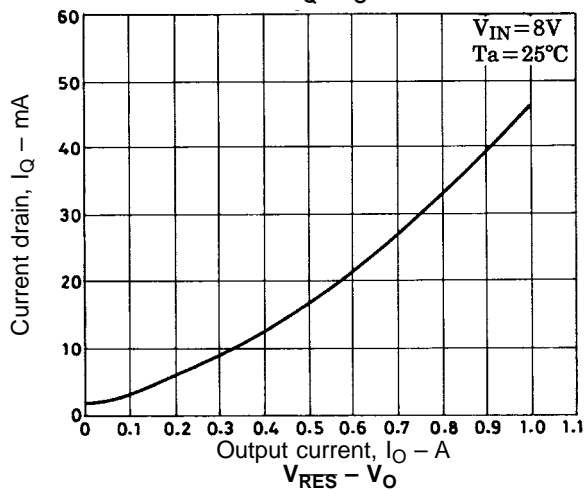
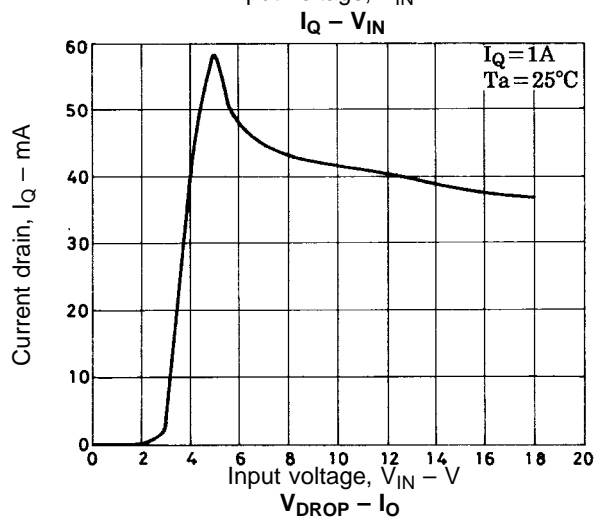
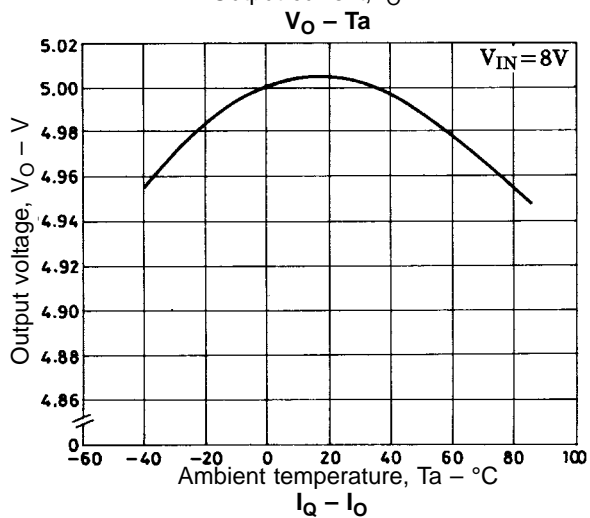
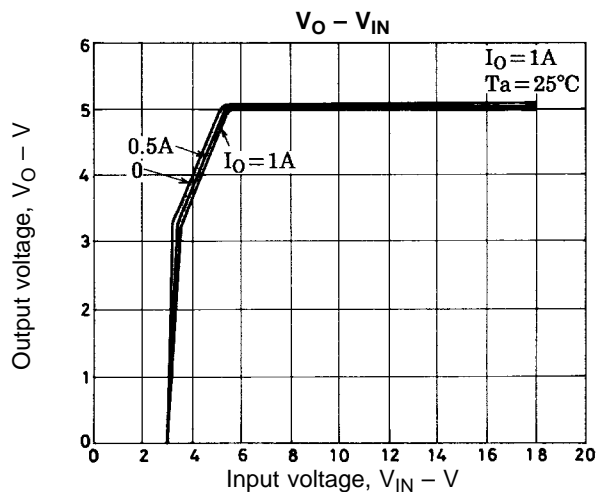
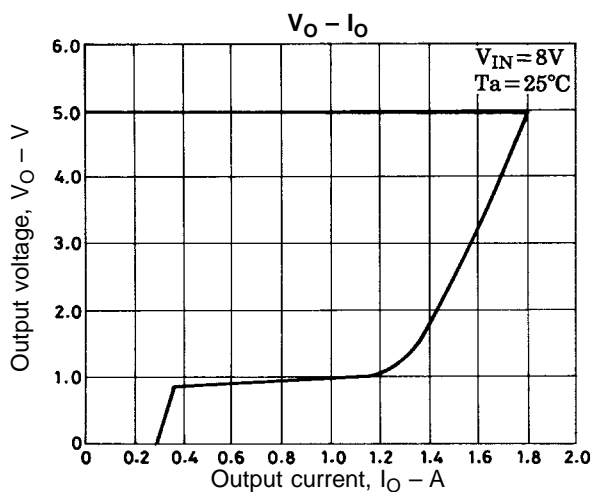

## L88R05 Series

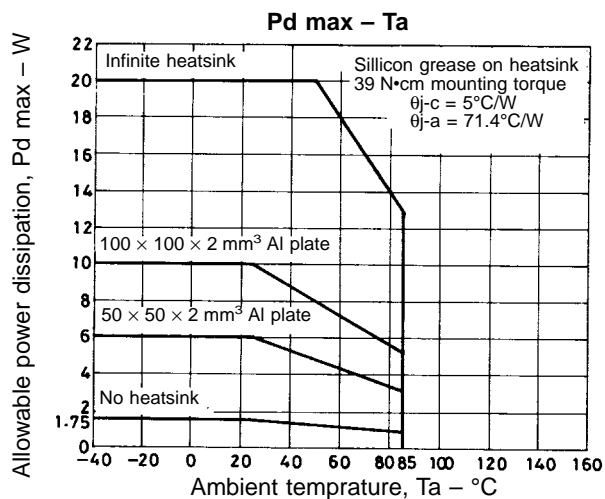
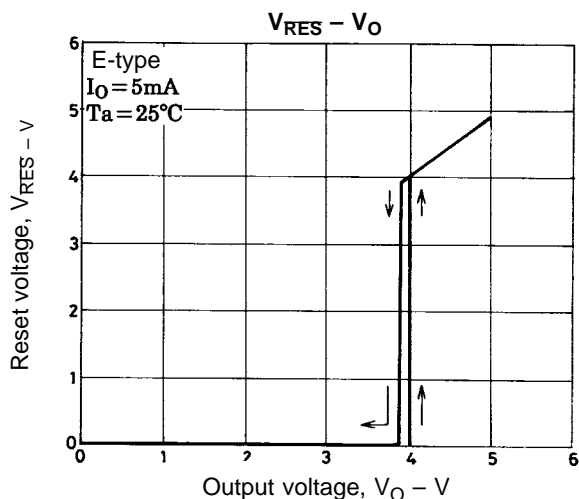

- Specifications of any and all SANYO products described or contained herein stipulate the performance, characteristics, and functions of the described products in the independent state, and are not guarantees of the performance, characteristics, and functions of the described products as mounted in the customer's products or equipment. To verify symptoms and states that cannot be evaluated in an independent device, the customer should always evaluate and test devices mounted in the customer's products or equipment.
- SANYO Electric Co., Ltd. strives to supply high-quality high-reliability products. However, any and all semiconductor products fail with some probability. It is possible that these probabilistic failures could give rise to accidents or events that could endanger human lives, that could give rise to smoke or fire, or that could cause damage to other property. When designing equipment, adopt safety measures so that these kinds of accidents or events cannot occur. Such measures include but are not limited to protective circuits and error prevention circuits for safe design, redundant design, and structural design.
- In the event that any or all SANYO products(including technical data, services) described or contained herein are controlled under any of applicable local export control laws and regulations, such products must not be exported without obtaining the export license from the authorities concerned in accordance with the above law.
- No part of this publication may be reproduced or transmitted in any form or by any means, electronic or mechanical, including photocopying and recording, or any information storage or retrieval system, or otherwise, without the prior written permission of SANYO Electric Co., Ltd.
- Any and all information described or contained herein are subject to change without notice due to product/technology improvement, etc. When designing equipment, refer to the "Delivery Specification" for the SANYO product that you intend to use.
- Information (including circuit diagrams and circuit parameters) herein is for example only ; it is not guaranteed for volume production. SANYO believes information herein is accurate and reliable, but no guarantees are made or implied regarding its use or any infringements of intellectual property rights or other rights of third parties.

This catalog provides information as of October, 1996. Specifications and information herein are subject to change without notice.