

## TCPLink Development System

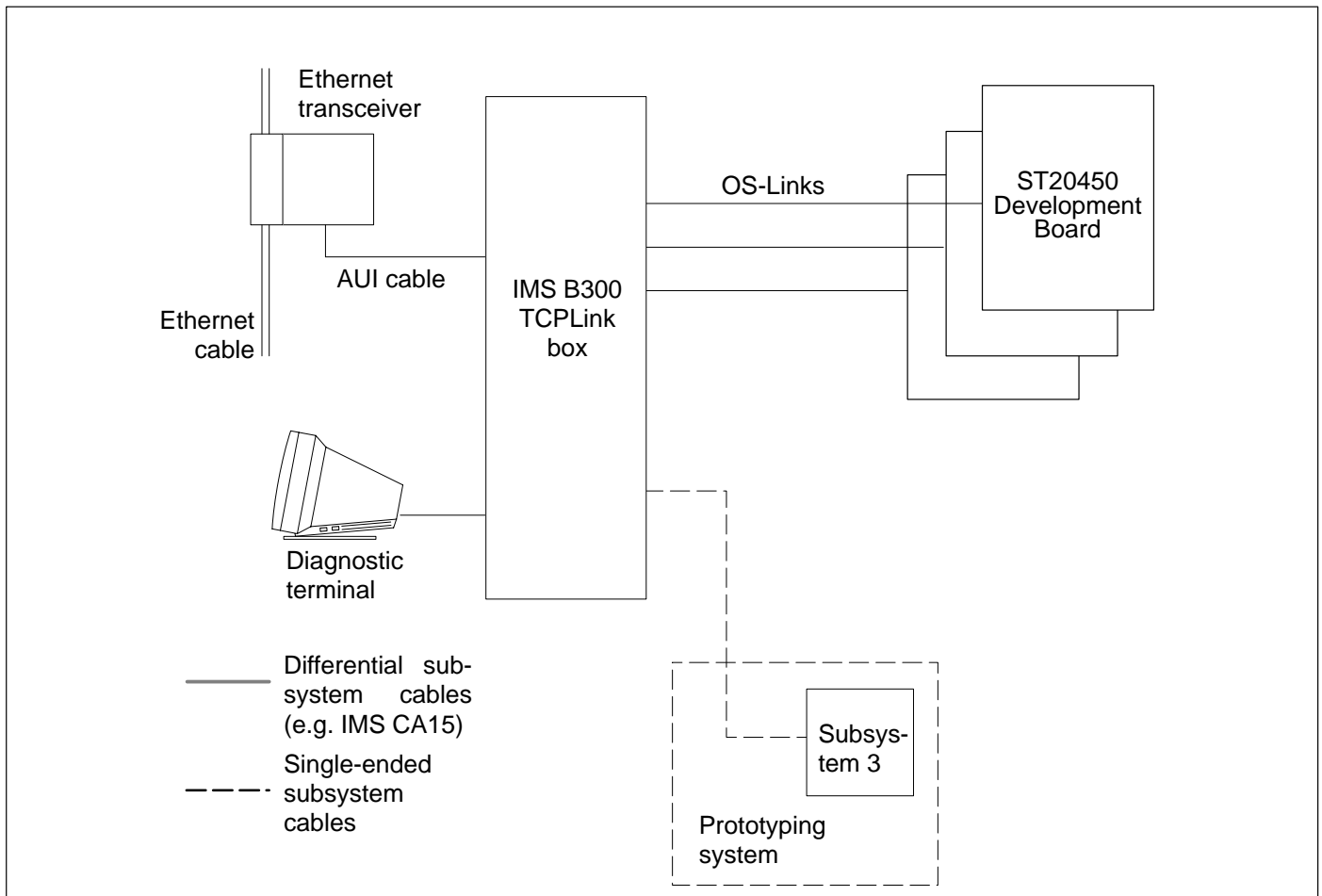

### FEATURES

- Compact desktop design, suitable for office or computer room environments
- Provides full interface to four independent networks over Ethernet
- Uses TCP/IP protocol suite
- Choice of single ended or differential link connections
- Independent diagnostics and test port simplifies installation of software enhancements
- LED activity indicators for each connection

### DESCRIPTION

The IMS B300 TCPLink box is a self-contained unit providing four links and associated system services for connection to target subsystems. The four links are accessed over an Ethernet network by host development computers running SGS-THOMSON Toolsets in conjunction with the TCP/IP protocol suite. The unit supports the development of programs in a network environment.

Diagnostic and monitoring facilities are provided via a serial port on the IMS B300. This may be connected to an ANSI compatible video terminal to give interactive information displays on the unit's operation.

# 1 Overview

The IMS B300 is a complete fully cased sub-system unit that supports the development of applications in a networked environment. Up to four target systems can be connected to the IMS B300. These can be connected up via differential cables to a target with a differential interface, such as the ST20450 Development Board or via a single ended cable such as the IMS CA16. The facilities can be shared amongst a larger group of development engineers and the use of network connections avoids the need to install interface hardware within each type of workstation.

The IMS B300 contains a high performance multi-processor implementation of the TCP/IP protocol stack, giving a network interface that is easily integrated into open-systems environments. A link service is offered over TCP connections giving transparent access to four subsystem and link interfaces from a host based environment.

Multiple IMS B300 systems can be installed for larger development groups, with shared access facilities controlled using a system of named link 'capabilities'.

The status and configuration of each IMS B300 system can be examined and monitored using an attached serial terminal which gives access to an interactive display capability. Front panel LEDs also give a continuous display of system activity.

# 2 Interfaces

## 2.1 Connection to Ethernet

The network connection provides an IEEE-802.3 AUI connection. This allows connections to either 10BASE-5, 10BASE-2 and 10BASE-T physical media via suitable 'tap boxes'.

A standard IEEE 802.3 AUI cable should be used to connect the IMS B300 to an Ethernet transceiver. The cable should be secured to the back panel connector using the slide lock provided. Suitable cables are available from transceiver vendors.

## 2.2 Connection to diagnostic terminal

The serial port on the rear panel may be connected to an ANSI compatible video terminal to give interactive information displays on the operation of the IMS B300. If this connection is not used, the IMS B300 will still operate as normal. Standard RS232 levels are used on the serial port (male 9-way D-type) which has a pin-out equivalent to that of an IBM PC AT serial socket. The serial cable supplied with the IMS B300 works with VT220 and VT320 ASCII terminals and compatibles or PCs running ASCII terminal emulation. The software on the IMS B300 programs the serial port to run at 9600 baud, 8 data bits, 1 stop bit, with XON/XOFF flow control. It is not necessary to use the hardware flow control lines (RTS and DTS) provided on the connector. An example cable description for the terminal cable is given in Figure 1.



Figure 1 Example cable connection to diagnostic terminal

## 2.3 Diagnostic functions

Diagnosis and monitoring of a 'live' unit is achieved via a serial port on the IMS B300. This expects to communicate with an ANSI compliant video terminal. A set of LEDs on the box front panel gives diagnostic information about the state of each interface.

# IMS B300 Ethernet connection system datasheet

One of the link connections has an associated services 'Up' port which can be connected to an IMS B008 or similar board in a PC. This allows field-service diagnosis of a dead unit which cannot boot-up from its own ROMs.

## 2.4 LED displays

The IMS B300 has seven front panel LED indicators. The right-most LED is the power indicator and should be illuminated when powered up. The other six LED's are under software control. Full details of their functions are given in [1].

## 3 Connecting the IMS B300 to a target network

The IMS B300 can have up to four separate networks connected to it which can be accessed individually through the Ethernet. These networks can be interfaced to the IMS B300 in one of the following ways:

- Single Ended
- Differentially

The different methods can be intermixed with each other if required.

Each network interface consists of a set of three subsystem control signals and a pair of link connections.

If the noise on the connection rises above TTL signal noise margins, due to long cables or noisy environments, the signals passing down the cable can be corrupted. Differential communications can be used to overcome both noise and earth loop problems. They have a higher noise margin making them far less susceptible to noise. No common ground is required for differential signals so earth loop problems are also reduced.

A single-ended electrical connection usually provides the simplest and most convenient option. This is because TRAMs and motherboards also use single-ended connections. However, in electrically noisy environments it is possible that single-ended connections can suffer from data errors. Although in practice such errors are usually not observed, it is not possible to ensure perfect error-free operation without using differential connections.

### 3.1 Connecting the IMS B300 to a differential target such as the ST20450 Development Board

For reliable operation in noisy environments, a differential cable should be used. Target systems such as the ST20450 Development Board [2] use a differential buffer to drive the OS-Link in addition to subsystem signals. A differential buffer circuit such as the one used for the ST20450 Development Board is shown in Appendix A.

Physical connections are made using the 92CAB053 differential cable supplied with the ST20450 Development Board, (order number ST20450-SAB/XXX). This cable is marked 'Host' and 'Target' at each end and should be connected accordingly, i.e. 'Host' connected to the IMS B300 and 'Target' to the front panel differential connector on the ST20450 Development Board, as shown in figure 3. Jumper J3 on the development board should be configured in the 'Front' position as shown in figure 2.

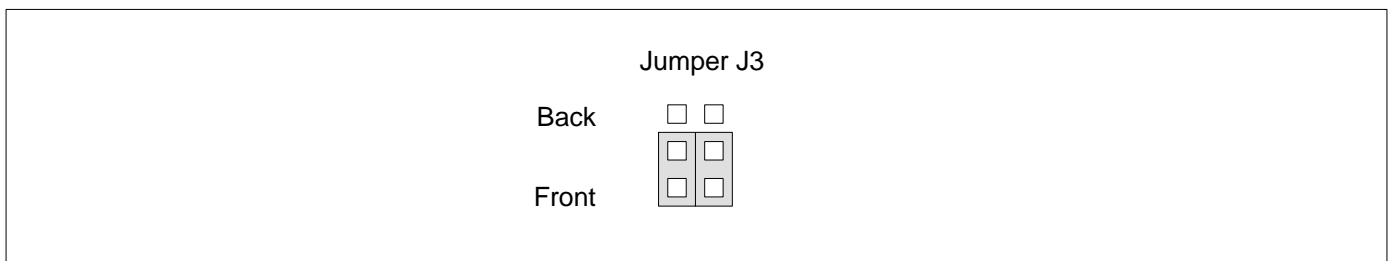

Figure 2 ST20450 Development Board J3 position

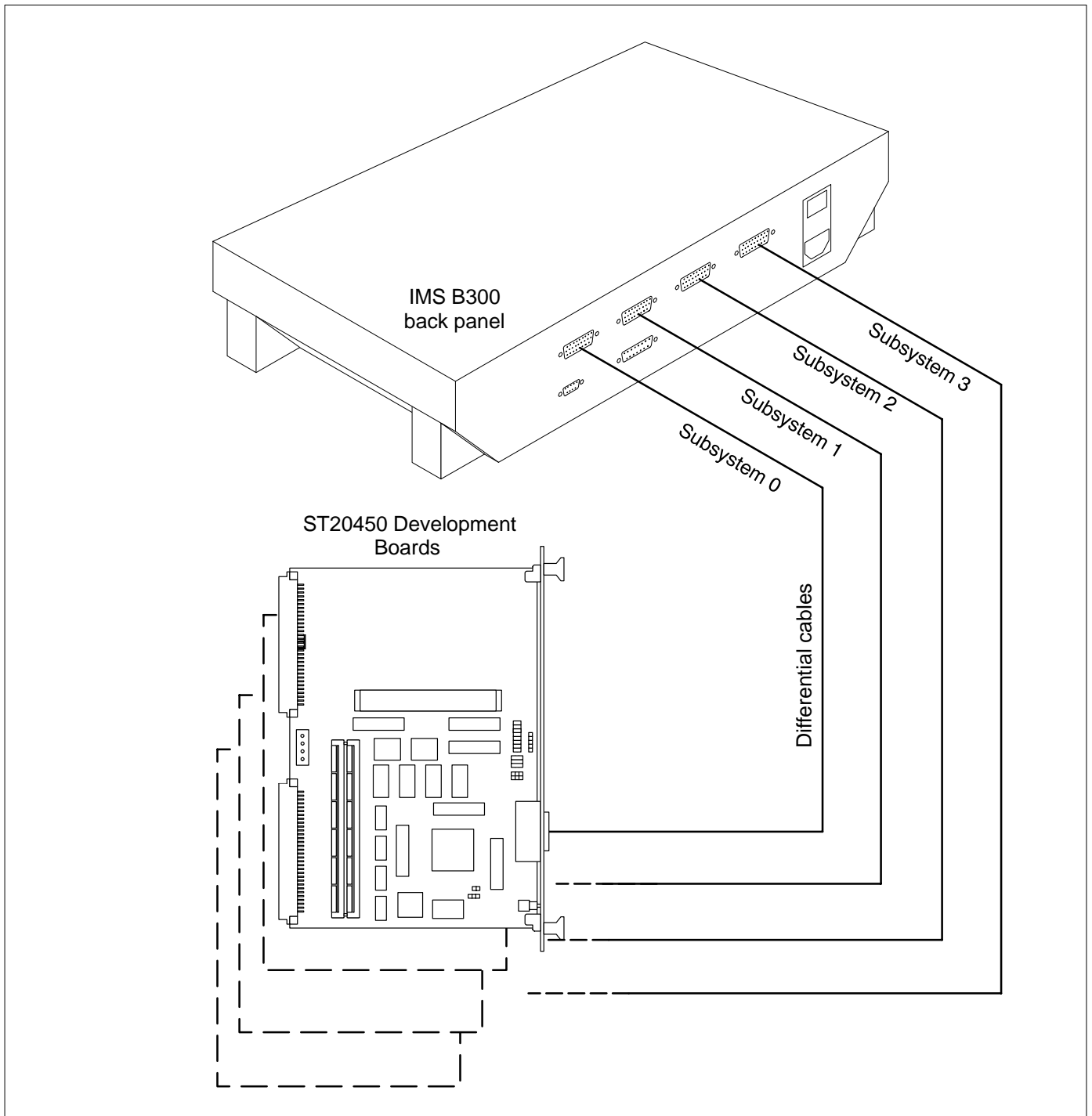

Figure 3 Connection of four IMS B300 differential cables to ST20450 Development Boards

### 3.2 Using single ended connections via the IMS CA16 cables

A single-ended connection cable of type IMS CA16 can be used to connect the 26 way differential link connector to a standard single ended OS-Link connector. The compact 'D' type connector mates with one of the subsystem connectors at the rear of the IMS B300. The other end terminates in three miniature M50 edge connector plugs polarised to match standard link and subsystem cable conventions.

## 3.2.1 Connections to an IMS B014

The use of the IMS CA16 cable in conjunction with the connectors on a IMS B014 standard VME motherboard is illustrated in figure 4. The jumper configuration of the motherboard is shown in figure 4. As can be seen, the single ended cable connections from the IMS B300 are mated with a 'breakout' connector or 'hedgehog' mounted in the P4 front panel connector of the IMS B014. A TRAM should be inserted in slot 0 of the IMS B014 motherboard array. Other TRAMs may be added to the motherboard as required. The IMS B014 can be inserted in a VME rack or used in a bench-top mode via a separate power supply.

Note that this example assumes the use of a 20Mbit/s link speed on both the IMS B300 subsystem and the IMS B014 motherboard. Also note that it is not possible to configure an IMS B014 to access the appropriate signal connections via its back panel (P2) connector.

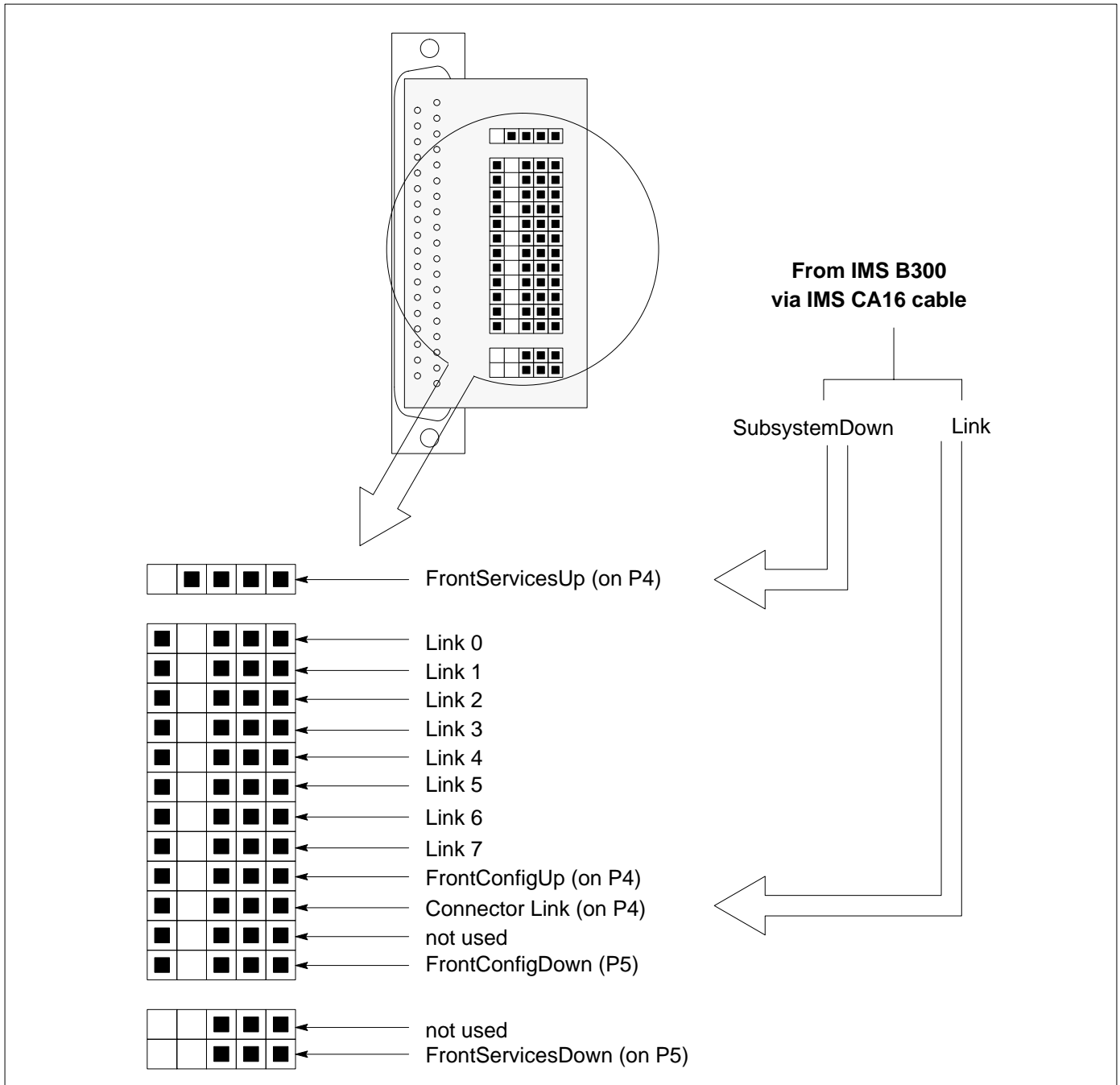

Figure 4 Front panel 'breakout' connector on P4 of IMS B014

---

## 4 Protocols

The TCP/IP Internet Protocol Suite, normally referred to as TCP/IP after the main standards, was developed for the DARPA/NSF Internet. The TCP/IP protocols have proved so popular that they are used for many networks not connected to the Internet.

The protocols, standards and policies of TCP/IP are published by the Network Information Center (NIC) and are known as Requests For Comments (RFCs). The TCP/IP protocols used by the TCPLink box are designed to conform to RFC 1122 "Host Requirements – Communications".

The IMS B300 incorporates firmware, implementing the following protocol elements:

- *Linkops Connection Server*  
Provides access to named subsystems over TCP/IP to remote users.
- *TCP and UDP transport services*  
The TCP implementation provides a reliable connection oriented transport layer, designed to meet Internet standards RFC793 and RFC 1122. UDP provides a datagram service, implemented to RFC768 and RFC 1122.
- *IP Network Layer*  
This layer is designed to meet Internet standards RFC791 and RFC1122 for IP layer behaviour.
- *Address Resolution Protocol*  
The dynamic Ethernet address resolution protocol, designed to meet Internet standards RFC826 and RFC1122.
- *Ethernet Data Link Layer*  
The Ethernet interface in the device encapsulates IP layer datagrams within Ethernet packets. The packetisation used is as specified in Internet standard RFC894 (i.e. Ethernet V2 Packetisation). The Data Link Layer requirements of RFC1122 are also met by this layer.

## 5 Performance

A raw TCP data-rate of several hundred kilobytes/second is supported. Some reduction in total data bandwidth may occur due to the host server or when multiple IMS B300 links are operating concurrently.

## 6 Specification

Feature	Value	Unit
Power dissipation	25	W
Operating temperature	10-40	°C
Weight	7	kg
Length	421	mm
Height	95	mm
Depth	251	mm

Links and system services signals are buffered to levels compatible with EIA RS-422. Inputs will also receive TTL compatible signals and one side of the outputs can be used to drive TTL compatible loads. The serial interface provides a functional subset of an EIA RS232 DCE. The IMS B300 is powered from AC mains and is compatible with worldwide mains supplies. The unit is shock and vibration resistant to a level consistent with office and air-freight standards.

### 6.1 Mains connection

The IMS B300 may be connected to either a 110V or 240V mains supply and will automatically switch to the supplied level. A clean mains supply is required in one of the two voltage ranges shown in Table 1. The IMS B300 must be earthed via the mains cable supplied. A mains fuse should be fitted to the power inlet module, rated as shown in Table 1. The

# IMS B300 Ethernet connection system datasheet

fuse holder is located behind a small cover immediately above the back panel mains socket. The mains cable must be unplugged before lifting this cover.

Mains supply voltage range	Fuse rating
90 - 132V AC	2A
175 - 264V AC	2A

Table 1 IMS B300 mains supplies and fuse ratings

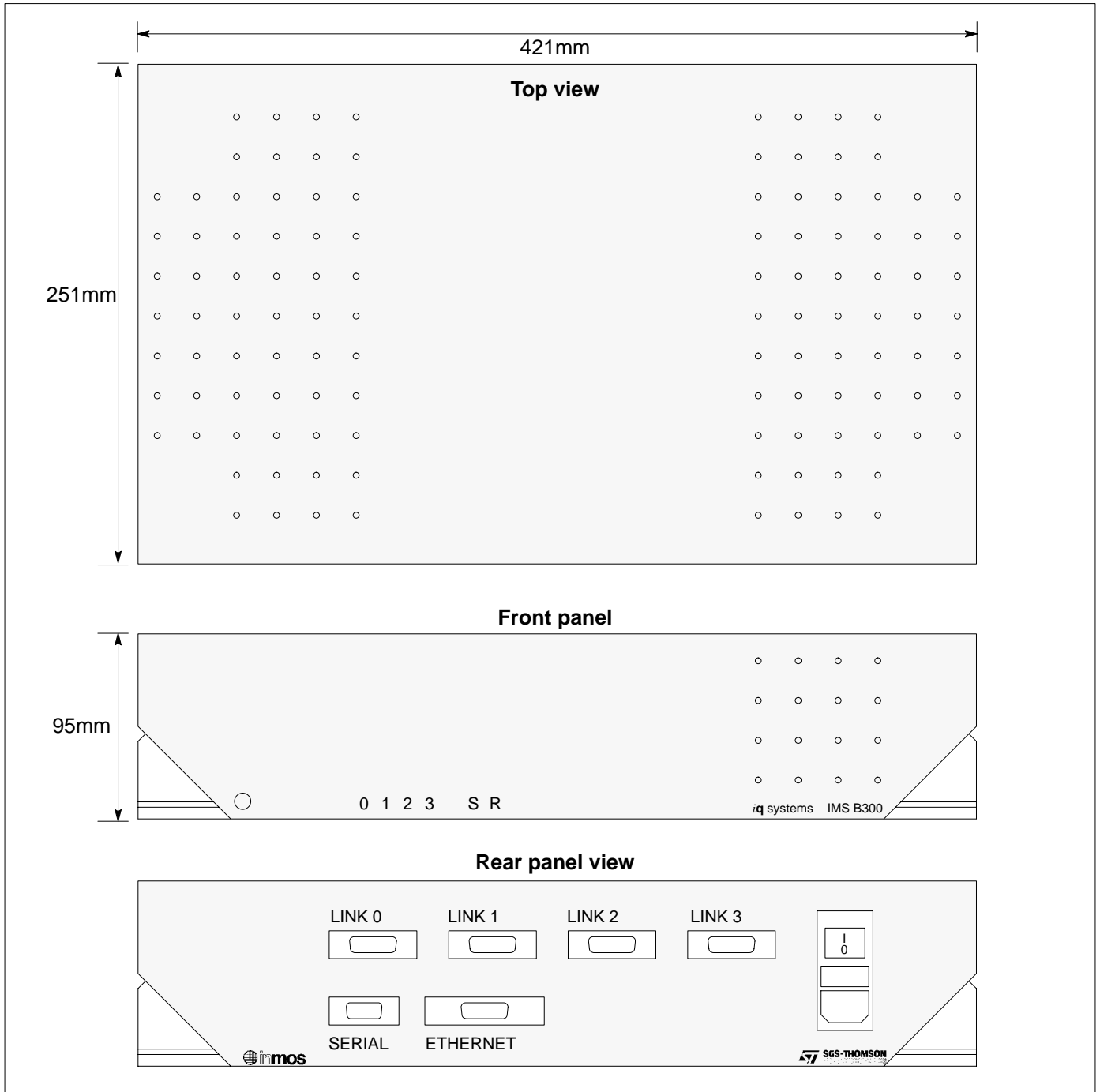

Figure 5 IMS B300 dimensions and connector positions

## 7 IMS B300 back panel connectors

### 7.1 Subsystem link connector (Link 0–3)

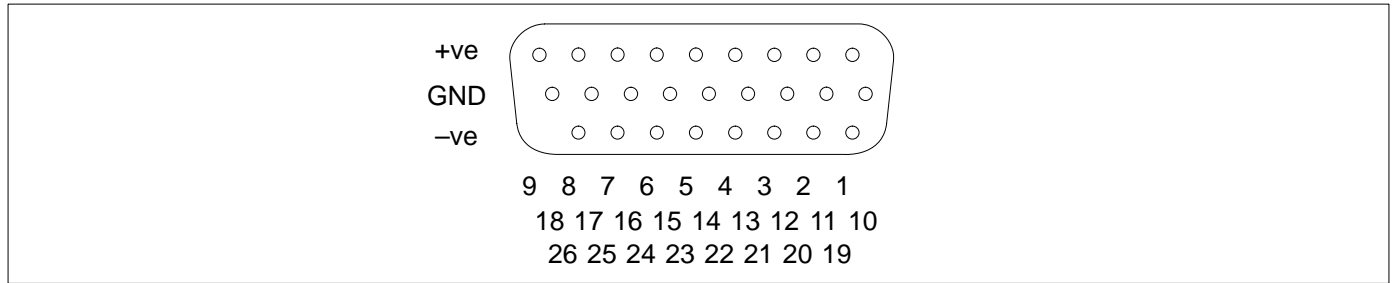

Figure 6 Subsystem link connector (viewed from rear panel)

Pin	Signal	Pin	Signal
1	+notSSDownReset	14	GND
2	+notSSDownAnalyse	15	GND
3	+notSSDownError	16	GND
4	+notSSUpReset	17	GND
5	+notSSUpAnalyse	18	GND
6	+notSSUpError	19	-notSSDownReset
7	+LinkOut	20	-notSSDownAnalyse
8	+LinkIn	21	-notSSDownError
9	GND	22	-notSSUpReset
10	GND	23	-notSSUpAnalyse
11	GND	24	-notSSUpError
12	GND	25	-LinkOut
13	GND	26	-LinkIn

Table 2 Subsystem link connector pinout



## 7.1.1 Ethernet connector

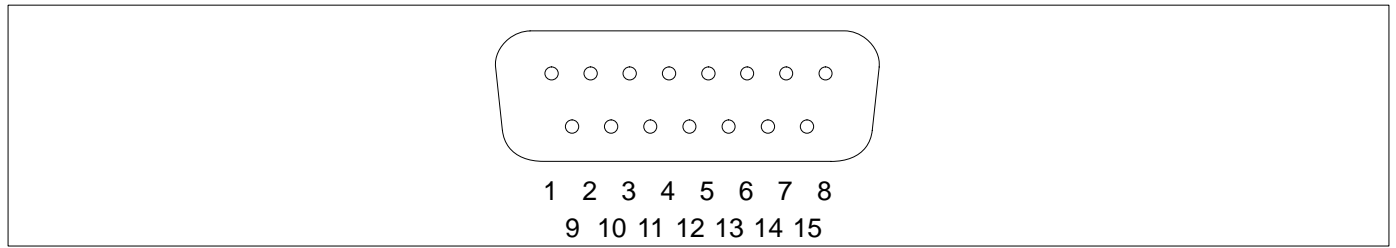

Figure 7 Ethernet connector (viewed from rear panel)

Pin	Signal	Pin	Signal
1	Logic Ref	9	Collision-
2	Collision+	10	Transmit-
3	Transmit+	11	Logic Ref
4	Logic Ref	12	Receive-
5	Receive+	13	Power
6	Power return	14	Logic Ref
7	N/C	15	N/C
8	Logic Ref		

Table 3 Ethernet connector pinout

## 7.1.2 Serial connector

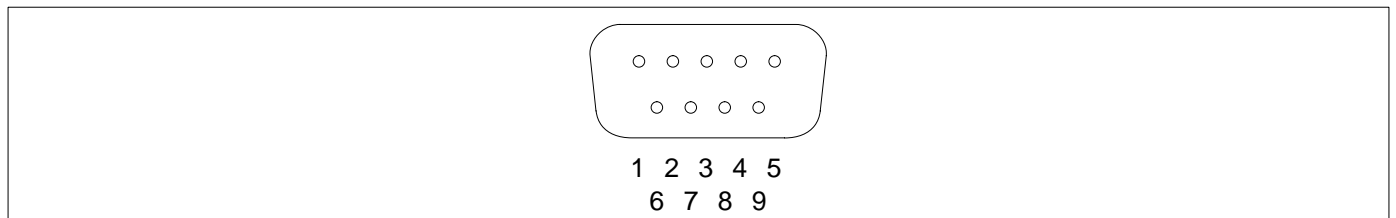

Figure 8 Serial connector (viewed from rear panel)

Pin	Signal	Pin	Signal
1	N/C	6	N/C
2	Rx data	7	RTS
3	Tx data	8	N/C
4	DTR	9	N/C
5	Ground		

Table 4 Serial connector pinout

## 8 Cables

An IMS CA16 single ended link cable is supplied with the IMS B300. However, the use of a differential link cable (IMS CA15) is recommended for use in electrically noisy environments.

---

## 9 Associated development software

The IMS B300 should be used in conjunction with current SGS–THOMSON development toolsets.

## 10 Support

Development toolkit products are fully supported by worldwide SGS-THOMSON sales offices and authorised distributors.

## 11 Ordering information

Description	Order number
IMS B300 network connection device	IMS B300-1

## 12 References

- 1 *IMS B300 TCPlink User Manual*, SGS–THOMSON Microelectronics Ltd 1996, 72 TRN 299 03
- 2 *ST20450 Development Board Datasheet*, SGS–THOMSON Microelectronics Ltd 1996, 42 1671 02

Appendix A Differential Buffer circuit

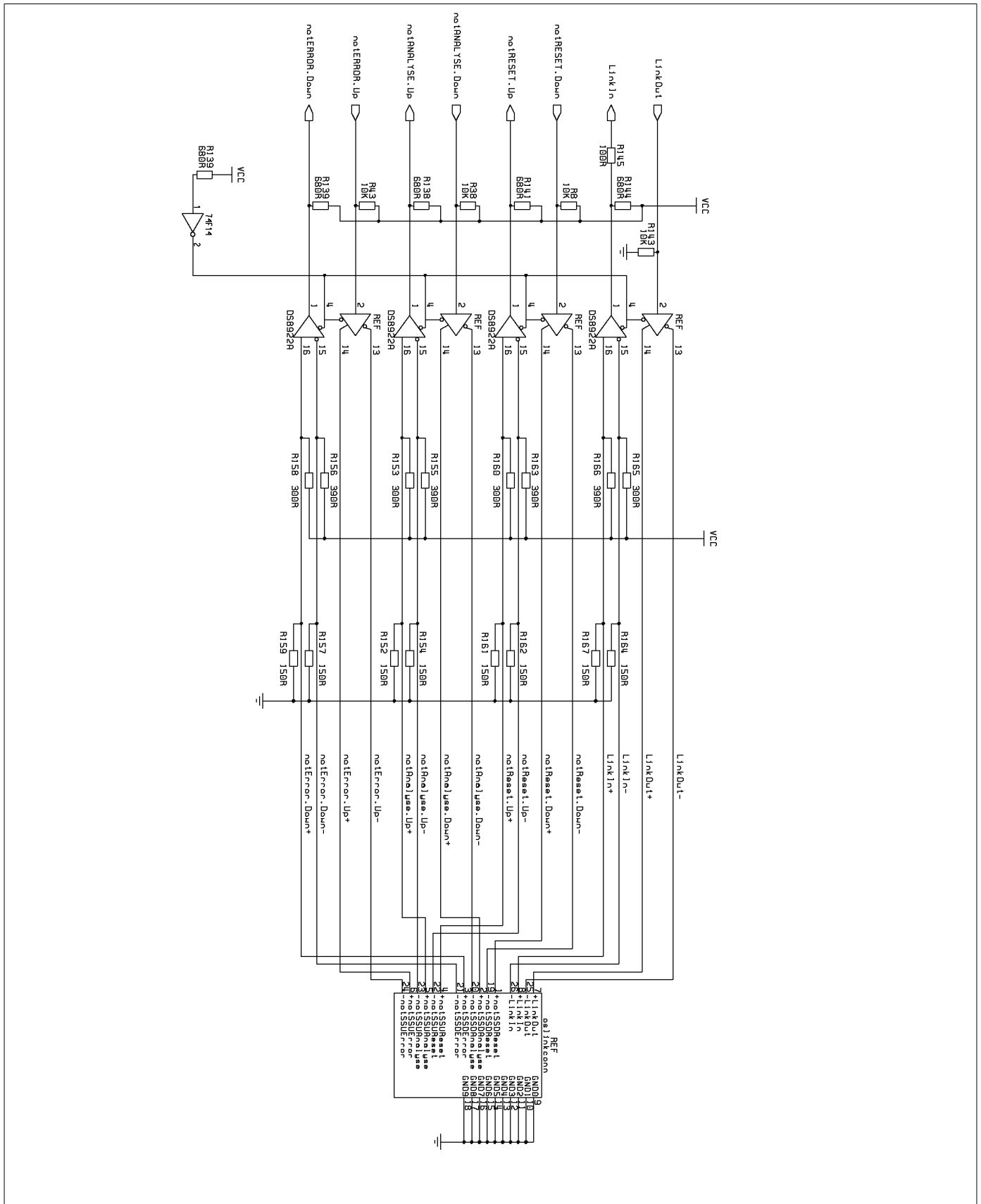

---

Information furnished is believed to be accurate and reliable. However, SGS-THOMSON Microelectronics assumes no responsibility for the consequences of use of such information nor for any infringement of patents or other rights of third parties which may result from its use. No license is granted by implication or otherwise under any patent or patent rights of SGS-THOMSON Microelectronics. Specifications mentioned in this publication are subject to change without notice. This publication supersedes and replaces all information previously supplied. SGS-THOMSON Microelectronics products are not authorized for use as critical components in life support devices or systems without express written approval of SGS-THOMSON Microelectronics.

© 1996 SGS-THOMSON Microelectronics - All Rights Reserved

 , **inmos** , IMS, occam and DS-Link are trademarks of SGS-THOMSON Microelectronics Limited.

 is a registered trademark of the SGS-THOMSON Microelectronics Group.

SGS-THOMSON Microelectronics GROUP OF COMPANIES  
Australia - Brazil - France - Germany - Hong Kong - Italy - Japan - Korea - Malaysia - Malta - Morocco -  
The Netherlands - Singapore - Spain - Sweden - Switzerland - Taiwan - Thailand - United Kingdom - U.S.A.