

FAST RECOVERY RECTIFIER DIODES

- HIGH VOLTAGE CAPABILITY
- FAST AND SOFT RECOVERY
- THE SPECIFICATIONS AND CURVES ENABLE THE DETERMINATION OF THE t_{rr} AND I_{RM} AT 100 °C UNDER USERS CONDITIONS
- INSULATED

APPLICATIONS

- MOTOR CONTROLS AND CONVERTERS
- SWITCH MODE POWER SUPPLIES

DESCRIPTION

Fast recovery rectifiers suited for applications in combination with superswitch transistors.

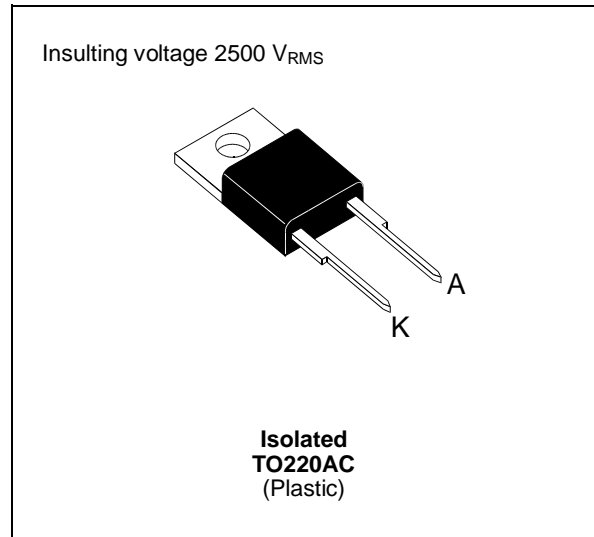

ABSOLUTE MAXIMUM RATINGS (limiting values)

Symbol	Parameter		Value	Unit
I_{FRM}	Repetitive Peak Forward Current	$t_p \leq 20\mu s$	120	A
$I_{F(RMS)}$	RMS Forward Current		16	A
$I_{F(AV)}$	Average Forward Current	$T_C = 100^\circ C$ $\delta = 0.5$	10	A
I_{FSM}	Surge non Repetitive Forward Current	$t_p = 10ms$ Sinusoidal	120	A
P_{tot}	Power Dissipation	$T_C = 100^\circ C$	20	W
T_{stg} T_j	Storage and Junction Temperature Range		- 40 to + 150 - 40 to + 150	°C

Symbol	Parameter	ESM 765PI-		Unit
		600	800	
V_{RRM}	Repetitive Peak Reverse Voltage	600	800	V
V_{RSM}	Non Repetitive Peak Reverse Voltage	600	800	V

THERMAL RESISTANCE

Symbol	Parameter	Value	Unit
$R_{th(j-c)}$	Junction-case	3.5	°C/W

ELECTRICAL CHARACTERISTICS

STATIC CHARACTERISTICS

Symbol	Test Conditions		Min.	Typ.	Max.	Unit
I _R	T _j = 25°C	V _R = V _{RRM}			20	μA
	T _j = 100°C				1	mA
V _F	T _j = 25°C	I _F = 10A			1.4	V
	T _j = 100°C				1.35	

RECOVERY CHARACTERISTICS

Symbol	Test Conditions			Min.	Typ.	Max.	Unit
t _{rr}	T _j = 25°C V _R = 30V	I _F = 1A	di _F /dt = - 15A/μs			300	ns
Q _{rr}	T _j = 25°C V _R = 200V	I _F = 10A	di _F /dt = - 50A/μs		2.3		μC

To evaluate the conduction losses use the following equations :

$$V_F = 1.2 + 0.015 I_F \quad P = 1.2 \times I_{F(AV)} + 0.015 I_{F(RMS)}^2$$

Figure 1. Low frequency power losses versus average current

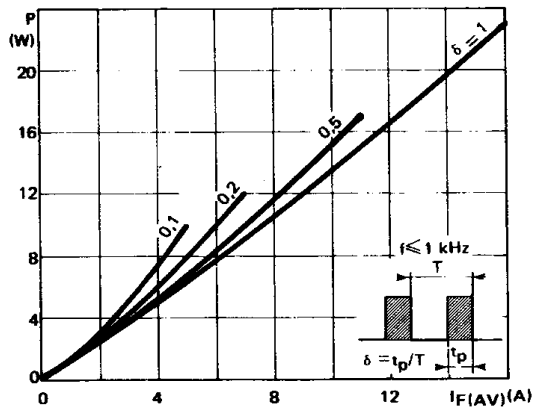

Figure 2. Peak current versus form factor

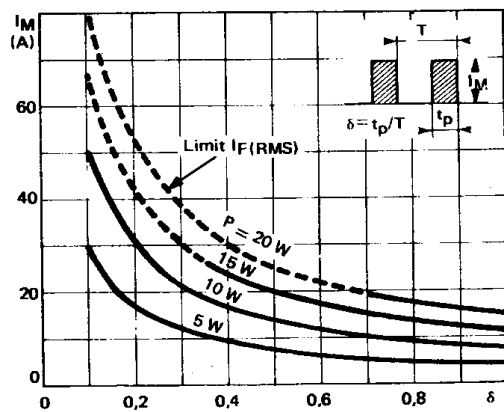

Figure 3. Non repetitive peak surge current versus overload duration

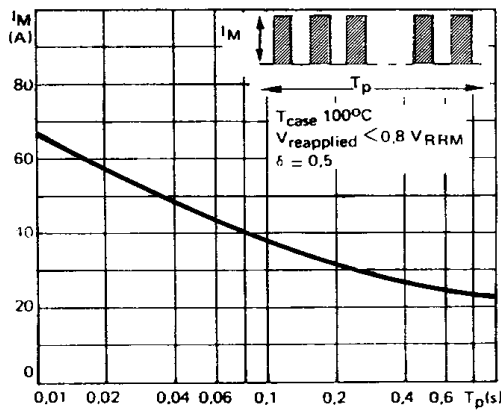

Figure 4. Thermal impedance versus pulse width

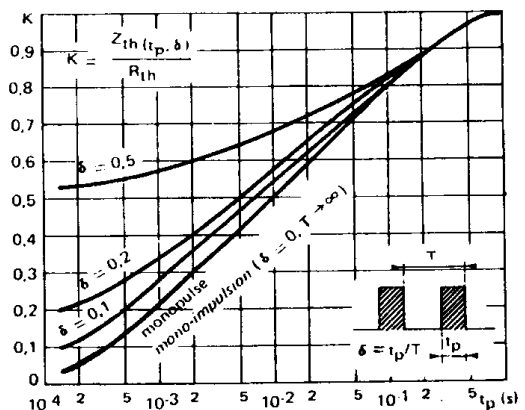

Figure 5. Voltage drop versus forward current

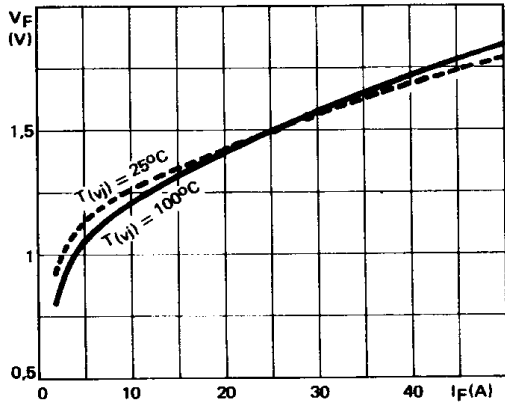

Figure 6. Capacitance versus applied reverse voltage

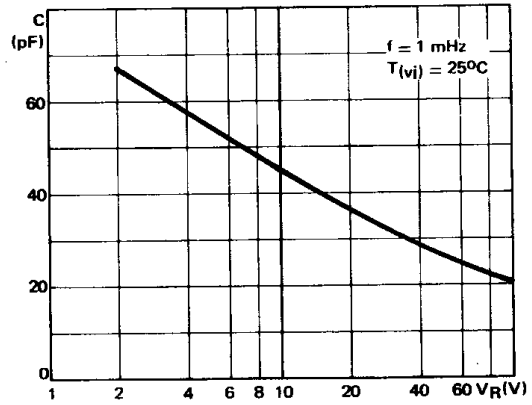

Figure 7. Recovery charge versus di_F/dt

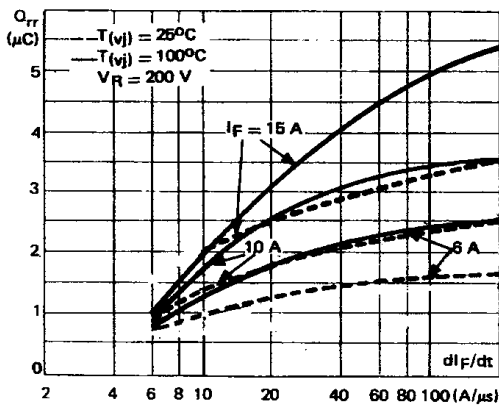

Figure 8. Recovery time versus di_F/dt

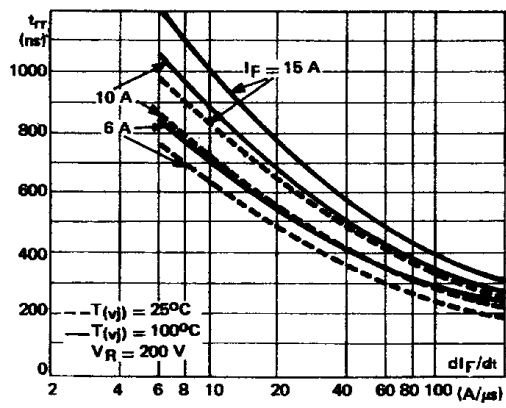
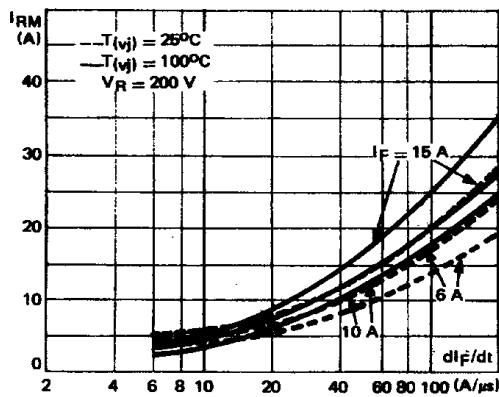
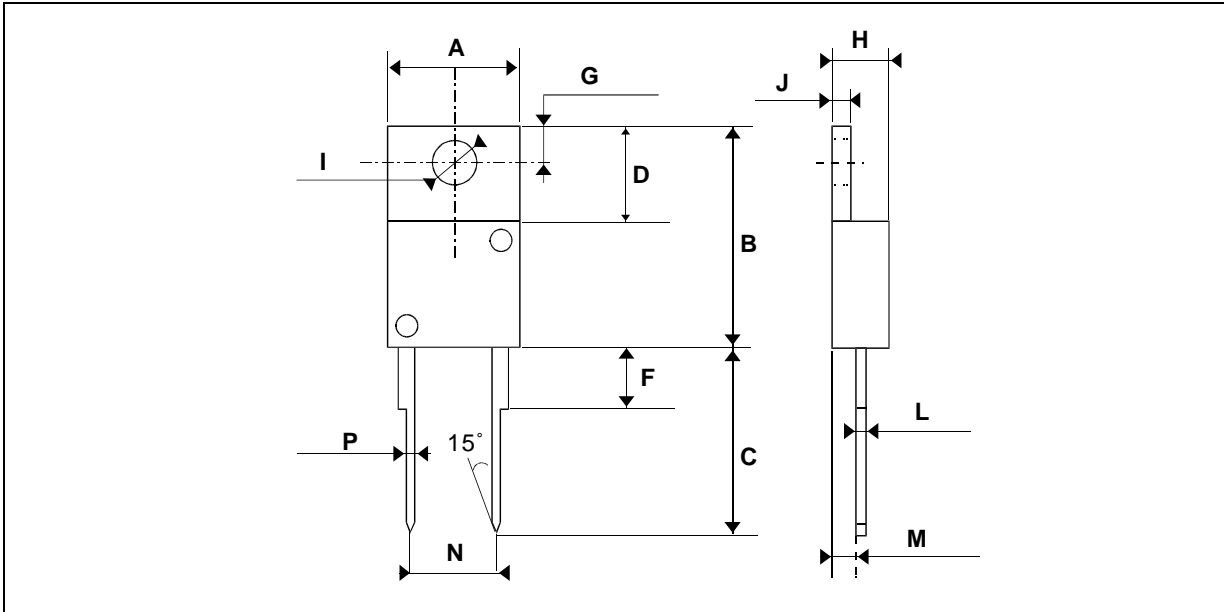

Figure 9. Peak reverse current versus di_F/dt



PACKAGE MECHANICAL DATA

Isolated TO220AC Plastic



Note: SGS-THOMSON reserves the right to have two notches on the heatsink.

REF.	DIMENSIONS			
	Millimeters		Inches	
	Min.	Max.	Min.	Max.
A	10.20	10.50	0.401	0.413
B	14.23	15.87	0.560	0.625
C	12.70	14.70	0.500	0.579
D	5.85	6.85	0.230	0.270
F		4.50		0.178
G	2.54	3.00	0.100	0.119
H	4.48	4.82	0.176	0.190
I	3.55	4.00	0.140	0.158
J	1.15	1.39	0.045	0.055
L	0.35	0.65	0.013	0.026
M	2.10	2.70	0.082	0.107
N	4.58	5.58	0.18	0.22
P	0.64	0.96	0.025	0.038

Cooling method : by conduction (method C)

Marking : type number

Weight : 2g

Recommended torque value : 80cm. N

Maximum torque value : 100cm. N

Information furnished is believed to be accurate and reliable. However, SGS-THOMSON Microelectronics assumes no responsibility for the consequences of use of such information nor for any infringement of patents or other rights of third parties which may result from its use. No license is granted by implication or otherwise under any patent or patent rights of SGS-THOMSON Microelectronics. Specifications mentioned in this publication are subject to change without notice. This publication supersedes and replaces all information previously supplied. SGS-THOMSON Microelectronics products are not authorized for use as critical components in life support devices or systems without express written approval of SGS-THOMSON Microelectronics.

© 1994 SGS-THOMSON Microelectronics - Printed in Italy - All rights reserved.

SGS-THOMSON Microelectronics GROUP OF COMPANIES

Australia - Brazil - France - Germany - Hong Kong - Italy - Japan - Korea - Malaysia - Malta - Morocco - The Netherlands
Singapore - Spain - Sweden - Switzerland - Taiwan - Thailand - United Kingdom - U.S.A.