

# DATA SHEET

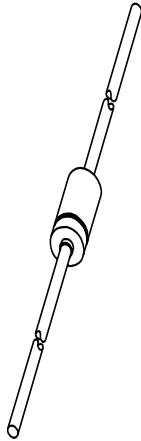

## **BA482; BA483; BA484** Band-switching diodes

Product specification  
Supersedes data of January 1982

1996 Apr 17

## Band-switching diodes

## BA482; BA483; BA484

## FEATURES

- Continuous reverse voltage:  
max. 35 V
- Continuous forward current:  
max. 100 mA
- Low diode capacitance:  
max. 1.0 to 1.6 pF
- Low diode forward resistance:  
max. 0.7 to 1.2  $\Omega$ .

## APPLICATION

- VHF television tuners.

## DESCRIPTION

Planar high performance band-switching diode in a hermetically sealed glass SOD68 (DO-34) package.

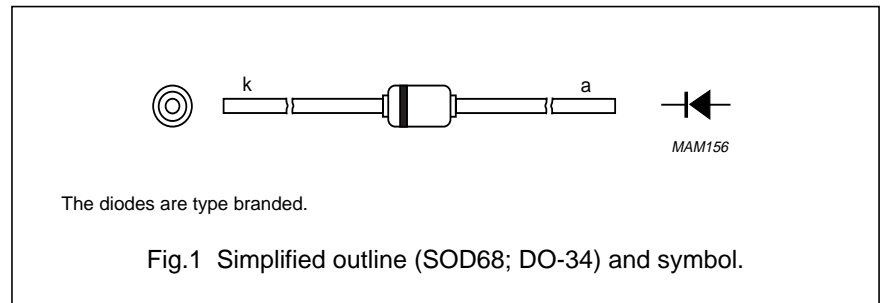

## LIMITING VALUES

In accordance with the Absolute Maximum Rating System (IEC 134).

| SYMBOL    | PARAMETER                  | MIN. | MAX. | UNIT               |
|-----------|----------------------------|------|------|--------------------|
| $V_R$     | continuous reverse voltage | –    | 35   | V                  |
| $I_F$     | continuous forward current | –    | 100  | mA                 |
| $T_{stg}$ | storage temperature        | –65  | +150 | $^{\circ}\text{C}$ |
| $T_j$     | junction temperature       | –    | 150  | $^{\circ}\text{C}$ |

## ELECTRICAL CHARACTERISTICS

$T_j = 25^{\circ}\text{C}$  unless otherwise specified.

| SYMBOL | PARAMETER                | CONDITIONS  | TYP. | MAX. | UNIT          |
|--------|--------------------------|---|------|------|---------------|
| $V_F$  | forward voltage          | $I_F = 100\text{ mA}$ ; see Fig.2                                 | –    | 1.2  | V             |
| $I_R$  | reverse current          | see Fig.3<br>$V_R = 20\text{ V}$                                  | –    | 100  | nA            |
|        |                          | $V_R = 20\text{ V}$ ; $T_{amb} = 75^{\circ}\text{C}$              | –    | 1    | $\mu\text{A}$ |
| $C_d$  | diode capacitance        | $f = 1\text{ to }100\text{ MHz}$ ; $V_R = 3\text{ V}$ ; see Fig.4 | 0.8  | 1.2  | pF            |
|        |                          |   | 0.7  | 1.0  | pF            |
|        |                          |   | 1.0  | 1.6  | pF            |
| $r_D$  | diode forward resistance | $I_F = 3\text{ mA}$ ; $f = 200\text{ MHz}$ ; see Fig.5            | 0.6  | 0.7  | $\Omega$      |
|        |                          |   | 0.8  | 1.2  | $\Omega$      |
|        |                          |   | 0.8  | 1.2  | $\Omega$      |

Band-switching diodes

BA482; BA483; BA484

THERMAL CHARACTERISTICS

| SYMBOL         | PARAMETER                                     | CONDITIONS                | VALUE | UNIT |
|----------------|---|---------------------------|-------|------|
| $R_{th\ j-tp}$ | thermal resistance from junction to tie-point | lead length 10 mm         | 300   | K/W  |
| $R_{th\ j-a}$  | thermal resistance from junction to ambient   | lead length 10 mm; note 1 | 500   | K/W  |

Note

1. Device mounted on a FR4 printed-circuit board without metallization pad.

GRAPHICAL DATA

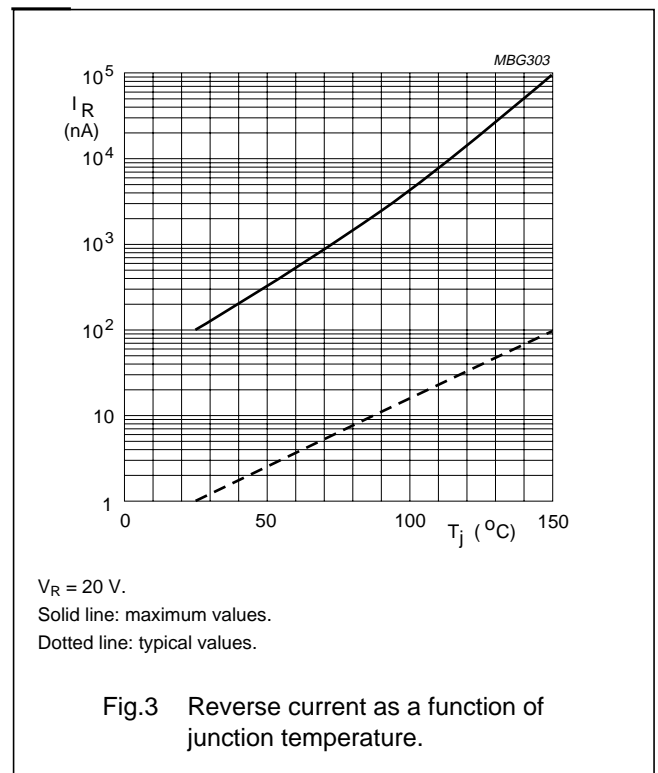
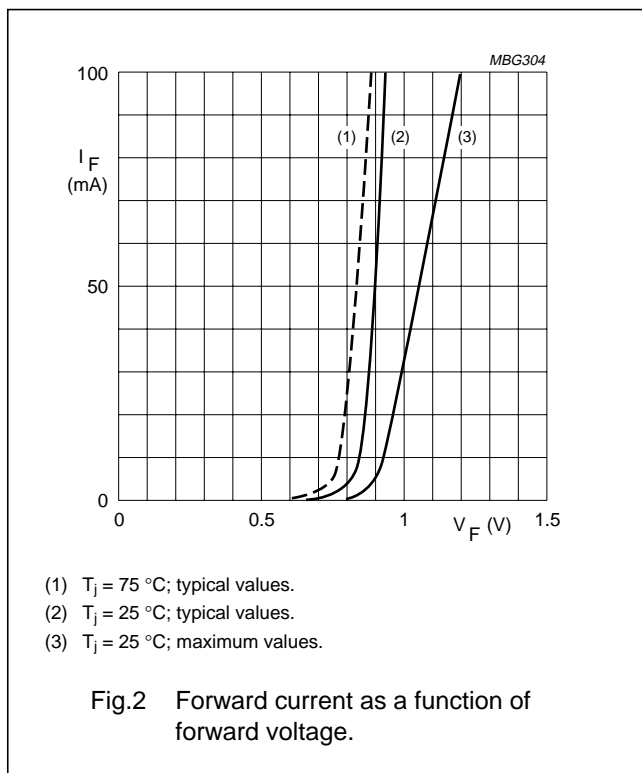

Band-switching diodes

BA482; BA483; BA484

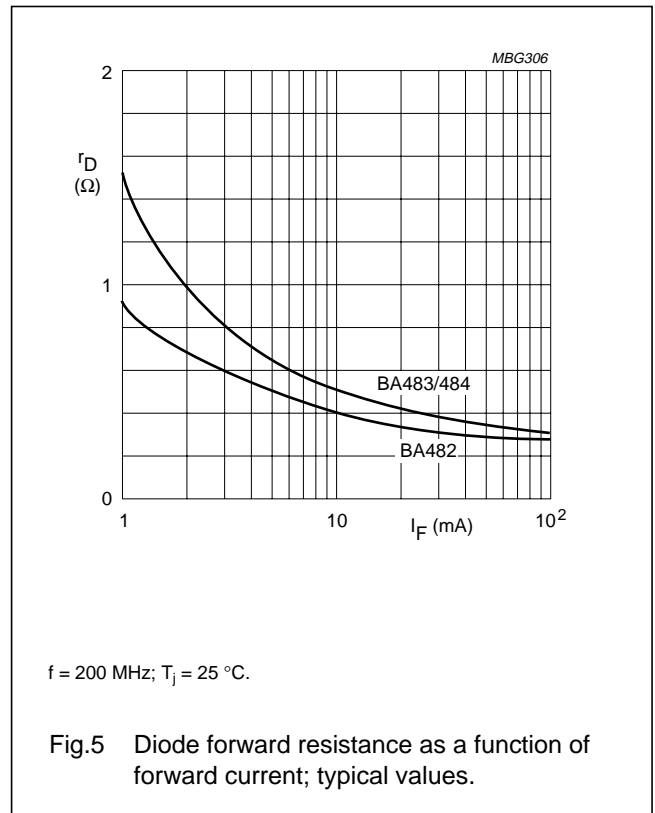
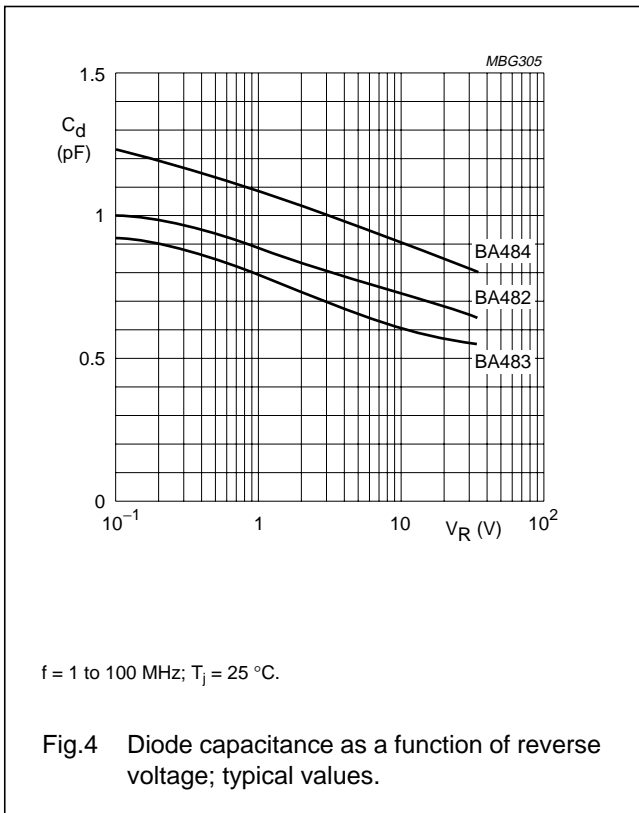

Band-switching diodes

BA482; BA483; BA484

PACKAGE OUTLINE

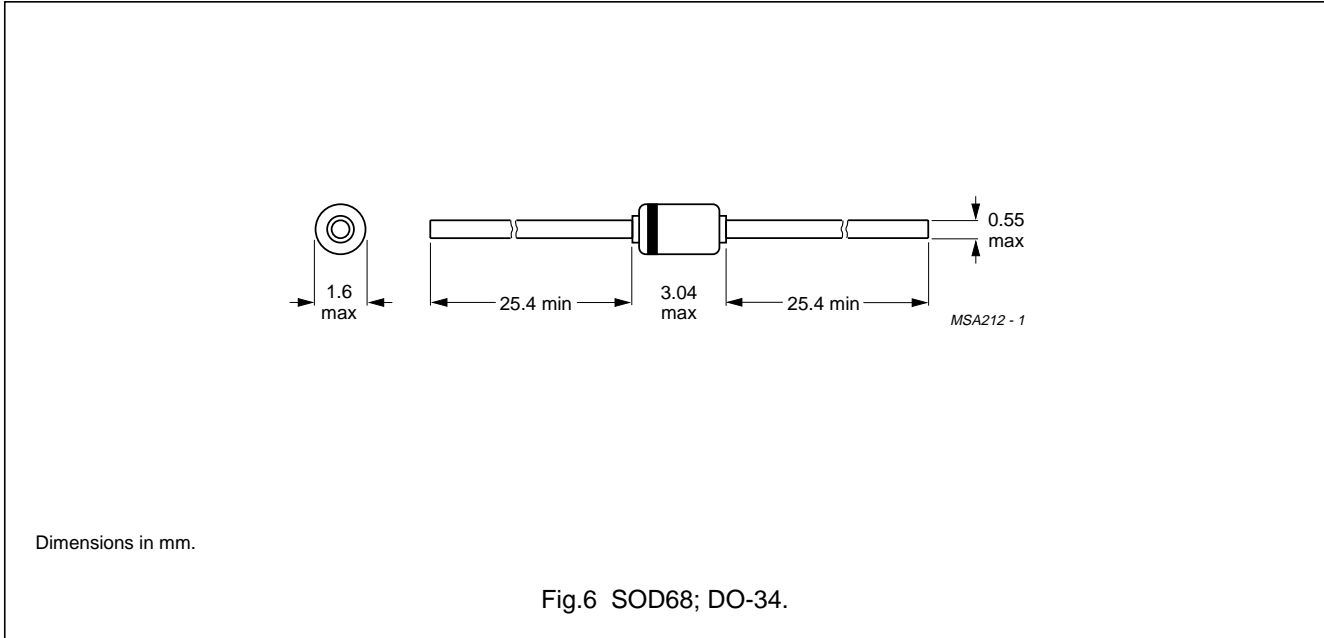

DEFINITIONS

|   |   |
|---|---|
| <b>Data Sheet Status</b>  |   |
| Objective specification   | This data sheet contains target or goal specifications for product development.       |
| Preliminary specification   | This data sheet contains preliminary data; supplementary data may be published later. |
| Product specification   | This data sheet contains final product specifications.                                |
| <b>Limiting values</b>  |   |
| Limiting values given are in accordance with the Absolute Maximum Rating System (IEC 134). Stress above one or more of the limiting values may cause permanent damage to the device. These are stress ratings only and operation of the device at these or at any other conditions above those given in the Characteristics sections of the specification is not implied. Exposure to limiting values for extended periods may affect device reliability. |   |
| <b>Application information</b>  |   |
| Where application information is given, it is advisory and does not form part of the specification.   |   |

LIFE SUPPORT APPLICATIONS

These products are not designed for use in life support appliances, devices, or systems where malfunction of these products can reasonably be expected to result in personal injury. Philips customers using or selling these products for use in such applications do so at their own risk and agree to fully indemnify Philips for any damages resulting from such improper use or sale.