

# AM radio / FM IF stereo system IC

## BA1442A

The BA1442A is an AM radio and FM IF stereo system IC developed for radio cassette players. The FM circuit is comprised of a differential IF amplifier, a double-balance type quadrature detector, and a PLL-type stereo MPX circuit. The AM circuit is comprised of a local oscillator, a double-balanced mixer, an IF amplifier, a detector, and an AGC circuit.

### ●Applications

Radio cassette players

### ●Features

- 1) The "S" curve characteristic of the FM detector can be used for upper heterodyne ("N" curve) operation.
- 2) Audio high cut and low cut can be used to improve the AM fidelity.
- 3) A reference voltage supply is provided to ensure good frequency stability in the shortwave bands.
- 4) Good FM stability.
- 5) Built-in damping resistor (3.3kΩ) for the quadrature coil.
- 6) The FM MPX uses a Laser Locked Loop, making adjustment of the VCO and addition of external components unnecessary.
- 7) Built-in forced monaural function for the MPX (VCO stops, LED off).
- 8) VCO of the MPX is switched off during AM operation.
- 9) The stereo indicator pin has a constant drive current, and a current limiting resistor is not required.
- 10) Few external components required.

### ●Absolute maximum ratings (Ta = 25°C)

Parameter	Symbol	Limits	Unit
Power supply voltage	V <sub>CC</sub>	9.0	V
Power dissipation	P <sub>d</sub>	550* <sup>1</sup>	mW
Operating temperature	T <sub>opr</sub>	-25~+75	°C
Storage temperature	T <sub>stg</sub>	-55~+125	°C

\*1 Reduced by 5.5mW for each increase in Ta of 1°C over 25°C.

### ●Recommended operating conditions (Ta = 25°C)

Parameter	Symbol	Limit	Unit
Power supply voltage	V <sub>CC</sub>	3.8~8.0* <sup>2</sup>	V

\*2 For basic operation at Ta = 25°C.

● Block diagram

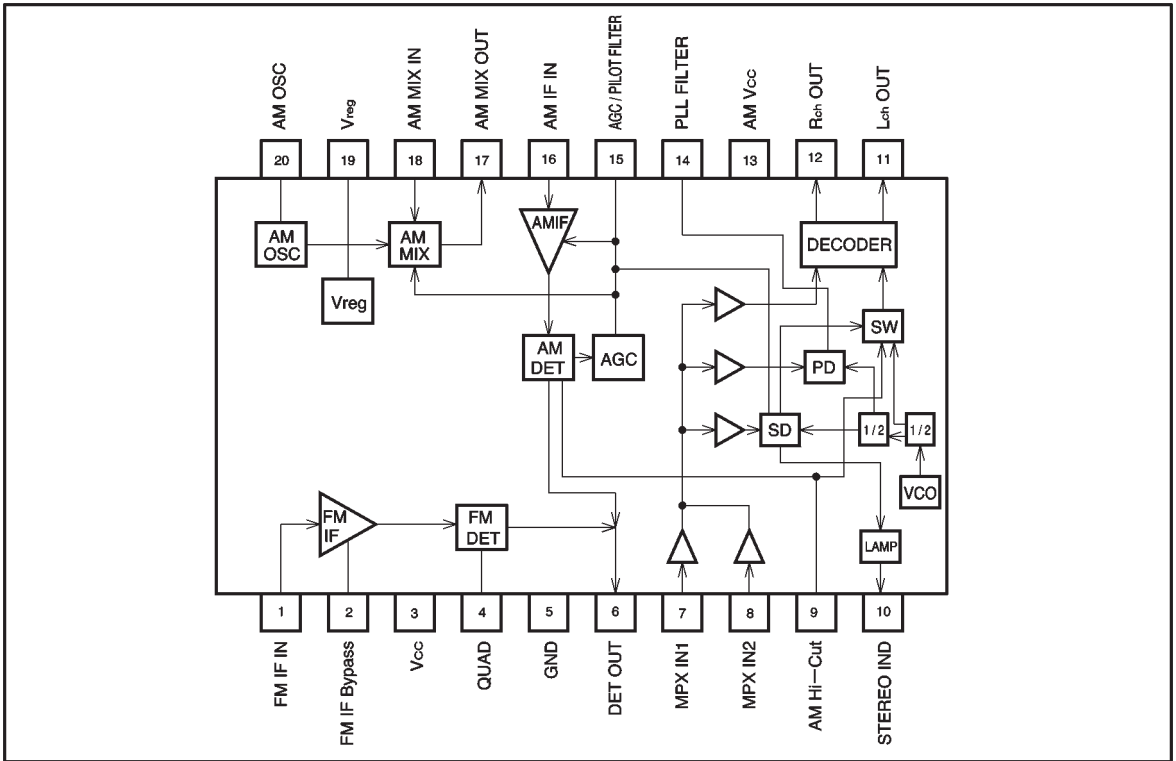

● Pin descriptions

Pin No.	Pin name	Function	Input/output circuit
1	FM IF input	Connect to an FM ceramic filter.	
2	FM IF bypass	Connect to a capacitor or pin 19.	
3	Vcc	—	—
4	FM discriminator	Connect to a phase shift coil.	
5	GND	—	—

Pin No.	Pin name	Function	Input / output circuit
6	AM/FM detector output	Connect to FM LPF and next-stage MPX.	
7	MPX input	Input the FM detector output.	
8	MPX input	Input the AM detector output after low cut.	
9	AM audio high cut Forced monaural	Connect to a capacitor. Forced monaural at 2.2V or above.	
10	Stereo indicator	Connect to an LED of stereo indicator. Constant drive current (10mA)	
11	L channel output	Connect to following stage power amplifier.	
12	R channel output	Connect to following stage power amplifier.	
13	AM power supply (band switch)	AM mode when power supply is connected.	—

Pin No.	Pin name	Function	Input / output circuit
14	PLL filter	Connect to a lag/lead filter.	
15	AM AGC Pilot filter	Connect to a capacitor.	
16	AM IF input	Connect to AM ceramic filter.	
17	AM mixer output	Connect to AM IFT primary side.	
18	AM antenna	Connect to AM antenna.	
19	Reference voltage	Connect to a capacitor.	—
20	AM local oscillator	Connect to AM OSC circuit.	



● Technical reference materials (unless otherwise noted,  $T_a = 25^\circ\text{C}$  and  $V_{cc} = 5\text{V}$ )

Note: The values given in the table below are representative values, and are not guaranteed.

Parameter	Symbol	Typ.	Unit	Conditions
〈FM IF〉				
IF input impedance	$Z_1$	330	$\Omega$	Pin1, $f=10.7\text{MHz}$
Quadrature impedance	$Z_4$	3.3	$\text{k}\Omega$	Pin4, $f=10.7\text{MHz}$
Detector output impedance	$Z_6$	5	$\text{k}\Omega$	Pin6, $f=400\text{Hz}$
〈FM MPX〉				
Stereo indicator on sensitivity	$\Delta f$	2.8	$\text{kHzdev}$	Degree of 19kHz modulation for $I_{10} \geq 1\text{mA}$
Stereo hysteresis	Hys	2	dB	Pin8, $f_{IN}=19\text{kHz}$ , $12.5\text{mVrms}$
Capture range	C.R	$\pm 5.26$	%	Pin8, $f_{IN}=19\text{kHz}$ , $12.5\text{mVrms}$
MPX input impedance	$Z_7$	20	$\text{k}\Omega$	Pin7, $f=400\text{Hz}$
MPX input impedance	$Z_8$	100	$\text{k}\Omega$	Pin8, $f=400\text{Hz}$
MPX output impedance	$Z_{11,12}$	5	$\text{k}\Omega$	Pins11 and 12, $f=400\text{Hz}$
19kHz carrier leak	$C_{L19}$	-30	dB	De-emphasis= $50\mu\text{s}$
38kHz carrier leak	$C_{L38}$	-56	dB	De-emphasis= $50\mu\text{s}$
Input/output voltage gain	$G_v$	6	dB	Pin7, $f=400\text{Hz}$
〈AM〉				
Total harmonic distortion	THD	1.5	%	$V_{IN}=68\text{dB}\mu\text{V}$ , $\text{mod}=80\%$
Mixer input impedance	$Z_{18}$	10	$\text{k}\Omega$	Pin18, $f=1000\text{kHz}$
Mixer output impedance	$Z_{17}$	100	$\text{k}\Omega$	Pin17, $f=455\text{kHz}$
IF input impedance	$Z_{16}$	3	$\text{k}\Omega$	Pin16, $f=455\text{kHz}$

### ● Circuit operation

(1) The FM IF amplifier is a three-stage differential amplifier. The gain of this stage is approximately 60dB. The bias for the first-stage amplifier is taken from the bypass filter (pin 2). This improves the FM stability of the first-stage amplifier by reducing noise. The input impedance is set by a resistor on the chip ( $330\Omega$ ), and can be connected to a ceramic filter.

(2) The FM detector circuit is comprised of a quadrature detector. The IF amplified signal is input to the detector via a limiter amplifier with a gain of 13dB.

(3) The AM mixer is a double-balance type, and has been designed for low local oscillator leakage. The mixer bias current is added from Vreg via antenna coil. If you lower the mixer conversion gain for mid- to high-strength electric fields, AGC will operate, and for high-strength electric fields, the input shunt AGC gives good strong-input characteristics.

(4) The AM local oscillator circuit consists of a differential positive feedback loop. To improve the frequency stability, particularly in the SW band, the circuit is operated with bias referenced to Vreg. To improve the startup characteristics, a  $100\Omega$  resistor is inserted in series with the tank circuit.

(5) The AM IF amplifier consists of two-stage differential amplifier. Both amplifiers use capacitors to block DC, so bypass capacitors are not necessary. The first stage amplifier has AGC. The gain of this stage is 47dB, and the input impedance is  $3\text{k}\Omega$ .

(6) AM detector circuit

A built-in envelope detector that uses a minute current serves as the AM detector. External components are not required.

(7) AM AGC circuit

AGC is applied to the input shunt, mixer, and IF circuits. The AGC reduces the mixer and IF circuit current, and according the DC level of the detector output, reduces the gain to control the output at a fixed level. In addition, an input shunt is provided to prevent distortion caused by strong input signals. The AGC pin is also used as the MPX PLL filter pin. For this reason, when there is no input, the AGC voltage becomes Vreg (pin 19), and when there is a strong input signal, it is about Vreg - 0.2V.

(8) AM/FM detector circuits

There is one pin for both detector outputs (pin 6), and the AM/FM switching is done internally. The output impedance is 5kΩ, and the DC output is 1.3V.

(9) The FM MPX circuit uses a PLL to recover the stereo. For FM, the input from pin 7 is switched by the decoder and output on pin 11 (L channel) and pin 12 (R channel). In the case of AM, the input is from pin 8, and this is output through to pins 11 and 12. The audio fidelity is improved by the low-pass filter comprised of the capacitor connected between pins 6 and 8 and the input impedance of pin 8 (20kΩ). The input/output gain for both AM and FM is about 6dB. The VCO has been laser trimmed on the chip to set its time constant. External components and re-adjustment are not required.

●Application example

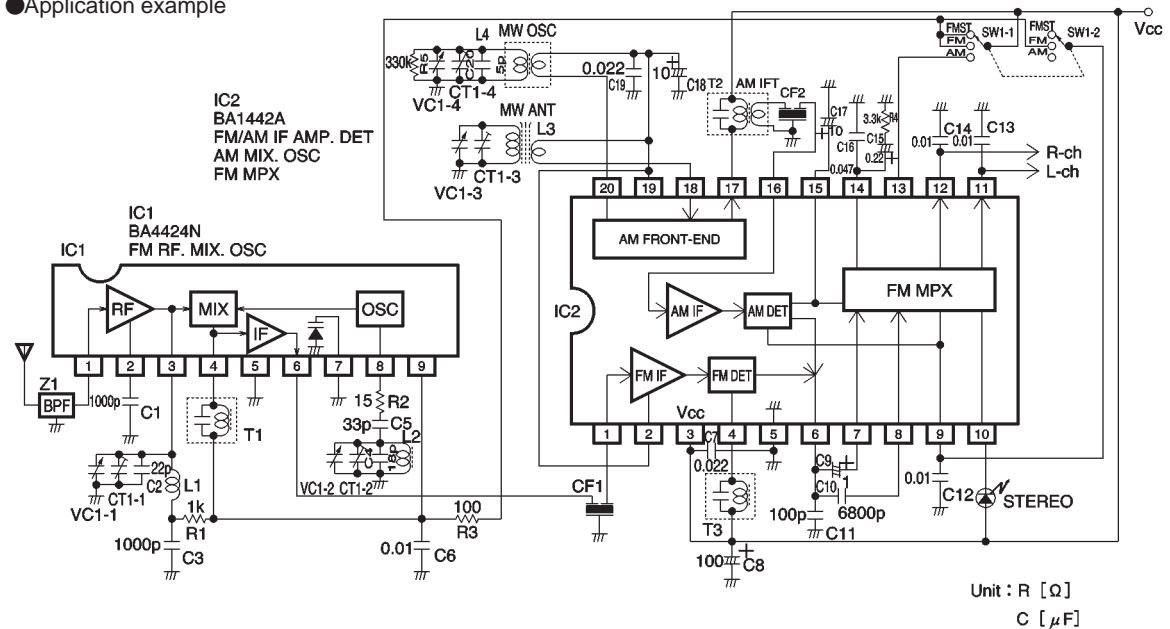

- Z1 : FM band-pass filter      BPMB6A (SOSHIN ELECTRIC CO.,LTD.)
- L1 : FM RF coil
- L2 : FM local oscillation coil      FEM10C-2F6 (SUMIDA ELECTRIC CO.,LTD.)
- L3 : MW bar antenna
- L4 : MW local oscillation coil      2157-JPS-029 (SUMIDA ELECTRIC CO.,LTD.) , A7BRS-12445X (TOKO,INC)
- T1 : FM IFT      0236-JPS-101 (SUMIDA ELECTRIC CO.,LTD.) , A119ACS-19197N (TOKO,INC)
- T2 : AM IFT      2150-JPS-025 (SUMIDA ELECTRIC CO.,LTD.) , A7MCS-12446X (TOKO,INC)
- T3 : FM discriminator coil      0236-JPS-101 (SUMIDA ELECTRIC CO.,LTD.) , A119ACS-19197N (TOKO,INC)
- CF1 : FM ceramic filter      FFE1070MA11FBL (TDK CORPORATION)
- CF2 : AM ceramic filter      FFD455-MB (TDK CORPORATION)
- VC : Polvariable capacitor      VCB48E (ALPS ELECTRIC CO.,LTD.)

Fig. 2

●Frequency data

Band	Frequency band	Nominal frequency	Tracking point	IF	Local oscillator frequency
MW	520~1750kHz	530~1710kHz	600 , 1400kHz	455kHz	Upper side
FM	87~109.5MHz	87.6~108MHz	(92) , 104MHz	10.7MHz	Upper side

●Component data

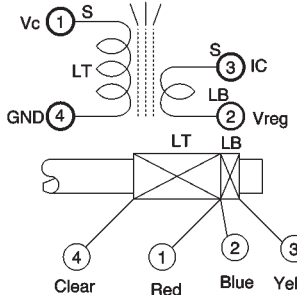
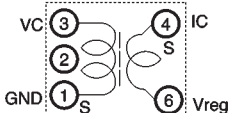
Part No.	Name	Code/manufacturer	Remarks
Z1	Band-pass filter	BPMB6A Soshin Electric Co., Ltd.	88~108MHz $Z_{IN}=75\Omega$ , $Z_{OUT}=75\Omega$
L1	FM RF coil	—	Printed coil
L2	FM OSC coil	FEM10C-2F6 Sumida Electric Co., Ltd.	 <p>①—③ 2 <math>\frac{1}{2}</math>T Wire type: <math>\phi</math> 0.6UEW No load Q = 115</p>
L3	MW bar antenna	—	 <p>VC ① S LT GND ④ ①—④ 94T ②—③ 16T S IC LB ② Vreg LT LB Core: <math>\phi</math> 10X60mm (material: NIL) ④ ① ② ③ Clear Red Blue Yellow</p> <p>Wire type: UDATC 5/0.07 Winding method: solenoid Inductance (1 - 4) = 554 <math>\mu</math>H Distributed capacitance = 5.5pF (Max.) Q=310<math>\pm</math>100 (500kHz) , 280<math>\pm</math>100 (1000kHz)</p>
L4	MW OSC coil	2157—JPS—029 Sumida Electric Co., Ltd. A7BRS-12445X Toko Co., Ltd.	 <p>VC: ③ ④ IC ①—③ 100T ② ⑤ ④—⑥ 9T GND: ① S ⑥ Vreg Wire type: <math>\phi</math> 0.06UEW</p> <p>Inductance = 256<math>\mu</math>H<math>\pm</math>6% Min., variable (796kHz) No load Q = 90Min. (796kHz) Distributed capacitance (1 - 3)= 7.5pF (Max.)</p>

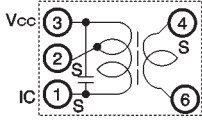
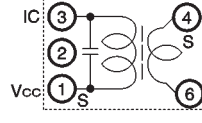
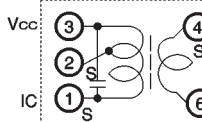

Part No.	Name	Code/manufacturer	Remarks												
T1	FM IFT	0236—JPS—101 Sumida Electric Co., Ltd. A119ACS-19197N Toko Co., Ltd.	 <p>①—② 8T ②—③ 5T ④—⑥ 3T Wire type: <math>\phi</math> 0.10MUEW</p> <p>Tuning frequency = 10.7MHz<math>\pm</math>3% Min., variable No load Q = 60 Min. (10.7MHz) Primary power supply impedance (1 - 3) = 14.6k<math>\Omega</math> (10.7MHz) Secondary power supply impedance (4 - 6) = 408<math>\Omega</math> (10.7MHz)</p>												
T2	AM IFT	2150—JPS—025 Sumida Electric Co., Ltd. A7MCS-12446X Toko Co., Ltd.	 <p>①—③ 117T ④—⑥ 6T Wire type: <math>\phi</math> 0.06UEW</p> <p>Tuning frequency = 455kHz<math>\pm</math>4% Min., variable No load Q = 60 Min. (455kHz) Tuning capacitance = 430pF<math>\pm</math>10%</p>												
T3	FM detector coil	0236—JPS—101 Sumida Electric Co., Ltd. A119ACS-19197N Toko Co., Ltd.	 <p>①—② 8T ②—③ 5T ④—⑥ 3T Wire type: <math>\phi</math> 0.10MUEW</p> <p>Tuning frequency = 10.7MHz<math>\pm</math>3% Min., variable No load Q = 60 Min. (10.7MHz) Primary power supply impedance (1 - 3) = 14.6k<math>\Omega</math> (10.7MHz) Secondary power supply impedance (4 - 6) = 408<math>\Omega</math> (10.7MHz)</p>												
CF1	FM ceramic filter	FFE1070MA11FBL TDK Co., Ltd.	3dB bandwidth = 280kHz $\pm$ 50kHz Input loss = 6.0 (2.7) dB Max.												
CF2	AM ceramic filter	FFD455—MB TDK Co., Ltd.	3dB bandwidth = 10kHz $\pm$ 3kHz Input loss = 5.0 (2.5) dB Max.												
VC	Variable policapacitor	VCB48E Alps Co., Ltd.	<table border="1"> <thead> <tr> <th>Stages</th> <th>Max. variable capacitance</th> <th>Min. capacitance</th> <th>Allowable capacitance difference</th> </tr> </thead> <tbody> <tr> <td>AM—2</td> <td>(O) 82pF (A) 160pF</td> <td>3.7<math>^{+0.5}_{-1}</math>pF</td> <td><math>\pm</math> (1pF+2%)</td> </tr> <tr> <td>FM—2</td> <td>20<math>\times</math>2</td> <td>3.1<math>^{+0.5}_{-1}</math>pF</td> <td><math>\pm</math> (0.4pF+2%)</td> </tr> </tbody> </table>	Stages	Max. variable capacitance	Min. capacitance	Allowable capacitance difference	AM—2	(O) 82pF (A) 160pF	3.7 $^{+0.5}_{-1}$ pF	$\pm$ (1pF+2%)	FM—2	20 $\times$ 2	3.1 $^{+0.5}_{-1}$ pF	$\pm$ (0.4pF+2%)
Stages	Max. variable capacitance	Min. capacitance	Allowable capacitance difference												
AM—2	(O) 82pF (A) 160pF	3.7 $^{+0.5}_{-1}$ pF	$\pm$ (1pF+2%)												
FM—2	20 $\times$ 2	3.1 $^{+0.5}_{-1}$ pF	$\pm$ (0.4pF+2%)												

● Selecting of attached components and operation notes

Pin 1: FM ceramic filter (CF<sub>1</sub>)

The input impedance of pin 1 is 330Ω, so it should be connected to a ceramic filter that has an output impedance of 330Ω. Connect the earth point of the ceramic filter to the input side GND. In addition, the connection distance between the ceramic filter and pin 1 should be as short as possible.

Pin 2: FM IF bypass

This pin is used to ensure stable FM, and it is normally connected to pin 19 (Vreg). If it is not possible to achieve stable FM, ground pin 2 via a 0.01μF capacitor. The earth point in this case will be on the GND side of the FM ceramic filter.

Pin 3: Power supply bypass capacitors (C<sub>7</sub> and C<sub>8</sub>)

C<sub>7</sub> should be a capacitor with good high-frequency characteristics. Connect it between the base of the legs of pin 3 (V<sub>CC</sub>) and pin 5 (GND). The purpose of C<sub>8</sub> is ripple rejection, and it can be connected a little further away.

Pin 4: FM quadrature detector phase-shift coil (T3)

Pin 3 and 4 are connected internally by a 3.3kΩ damping resistor. The earth point for the phase-shift coil should be V<sub>CC</sub>, so ensure that it is at the same voltage as pin 3 (V<sub>CC</sub>).

Pin 6: FM detector low-pass filter capacitor (C<sub>11</sub>)

This capacitor smooths the 2 × 10.7MHz (21.4MHz) signal generated by FM quadrature detection, and prevents leakage of the 10.7MHz signal. The output impedance of pin 6 (5kΩ) and C<sub>11</sub> form a low-pass filter. Connect the earth point to a GND other than the input side GND. If you do not do this, the input carrier will return from the output, and may result in poor stability.

If the capacitor is too large, poor separation will result.

Pin 7: FM detector output coupling capacitor (C<sub>9</sub>)

FM detector output is input to the MPX through C<sub>9</sub>. The input impedance of pin 7 (100kΩ) and C<sub>9</sub> form a high-pass filter. If the value of C<sub>9</sub> is too low, poor bass region separation will result.

Pin 8: AM detector output coupling capacitor (C<sub>10</sub>)

AM detector output is input to the MPX through C<sub>10</sub>. The input impedance of pin 8 (20kΩ) and C<sub>10</sub> form a high-pass filter and improves the AM fidelity. Characteristic curves for different values of C<sub>10</sub> are given in the graph in Fig. 3.

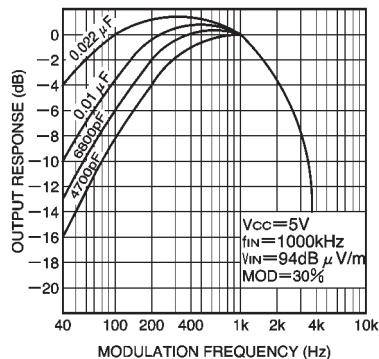

Fig. 3 AM fidelity characteristics

Pin 9: AM high-cut capacitor (C<sub>12</sub>)

The input impedance of pin 9 (8kΩ) and C<sub>12</sub> form a low-pass filter. To prevent beat from occurring between carrier leak from the detector output pin and the input signal, connect a capacitor of about 1000pF, even if not using high-cut. Connect the earth point to a GND other than the input side GND. Characteristic curves for different values of C<sub>12</sub> are given in the graph in Fig. 4.

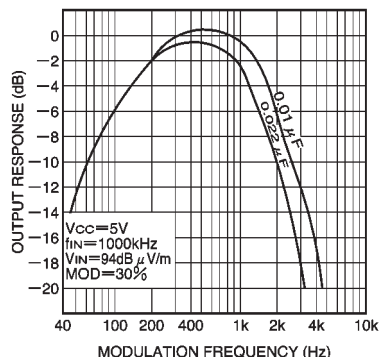

Fig. 4 AM fidelity characteristics

## Pin 9: Forced monaural (SW1)

If the voltage on pin 9 goes to 2.2V or higher in FM mode, forced monaural operation starts (VCO stops, the stereo indicator goes off, and audio output goes monaural). Do not apply a voltage to pin 9 that is higher than the voltage on pin 3 ( $V_{CC}$ ). Also, when in AM mode, the AM detector output is output on pin 9, so use a switch to switch pin 9 open circuit in AM mode, as shown in the application circuit example. If you change the voltage on pin 9 during AM operation, the AGC characteristics will be disturbed.

## Pin 10: Stereo indicator

The pin 10 current is fixed at 10mA, so an external current-limiting resistor is not required. If you wish to reduce the brightness of the LED, connect a resistor in parallel to reduce the current. If you do not wish to use stereo indication, connect pin 10 directly to the power supply, however, the current consumption is that same as that when stereo indication is used. The withstanding voltage of pin 10 is 9V, so use caution when connecting it to power sources other than the IC power supply.

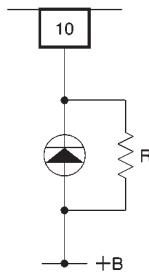

Fig. 5

## Pins 11 and 12

De-emphasis capacitors ( $C_{13}$  and  $C_{14}$ )

The output impedance of pins 11 and 12 ( $5k\Omega$ ), and  $C_{13}$  and  $C_{14}$  set the de-emphasis time constant ( $50\mu\text{sec.}$  for  $0.01\mu\text{F}$ , and  $75\mu\text{sec.}$  for  $0.015\mu\text{F}$ ). Do not connect  $C_{13}$  and  $C_{14}$  if composite (voice multiplex etc.) signal processing will be performed at the following stage.

## Pin 13: AM/FM switching noise reduction filter

Pin 13 is the AM power supply pin. When power is applied, the circuit is in AM mode. By setting a CR time constant, it is possible to reduce the audible switching noise that occurs when switching between AM and FM. Choose the resistor so that the voltage drop across the resistor is 0.5V max. with respect to the pin 3 ( $V_{CC}$ ). Do not apply a voltage higher than the voltage on pin 3 ( $V_{CC}$ ) to pin 13.

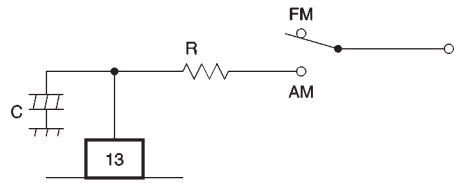

Fig. 6

Pin 14: PLL filter ( $C_{15}$ ,  $C_{16}$ , and  $R_4$ )

PLL loop filter for the MPX. Varying the values of these components changes the capture range of the PLL, but can also result in PLL beat, or the PLL going out of lock due to temperature changes, so do not change these component values.

Pin 15: Pilot filter and AGC filter ( $C_{17}$ )

Pin 15 is used by both the MPX pilot filter and the AM AGC filter. Lower values for  $C_{17}$  will result in increased THD for bass-region AM audio, and larger values will increase the time required to switch between monaural and stereo for FM. Characteristic curves for various values of  $C_{17}$  are given in Figs. 7 to 9.

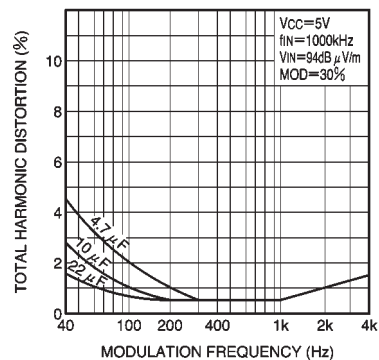

Fig. 7 Fidelity characteristics (30% modulation)

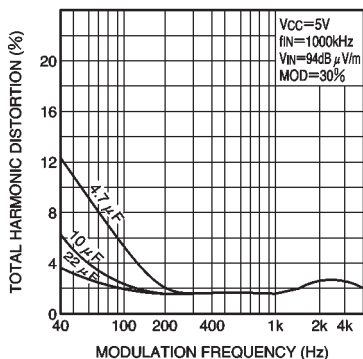

Fig. 8 Fidelity characteristics (30% modulation)

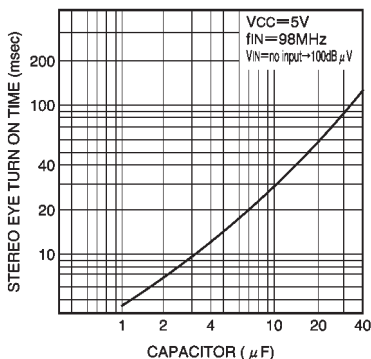

Fig. 9 Stereo eye turn on time vs. capacitor value

Pin 16: AM ceramic filter (CF<sub>2</sub>)

The input impedance of pin 16 is 3kΩ, so it should be connected to a ceramic filter that has an output impedance of 3kΩ. The connection distance between the ceramic filter and pin 16 should be as short as possible.

Pin 17: AM IFT (T<sub>2</sub>)

The output impedance of pin 17 is 100kΩ. The IFT earth point is V<sub>CC</sub>; make the voltage at pin 17 the same as the pin 3 (V<sub>CC</sub>) potential. The connection distance between the IFT and pin 17 should be as short as possible.

Pin 18: AM antenna (L<sub>3</sub>)

The input impedance of pin 18 is 10kΩ. The AM antenna earth point is V<sub>reg</sub>; make the voltage at pin 18 the same as the pin 19 (V<sub>reg</sub>) potential. If there is a voltage drop, local oscillator leakage to the mixer output will increase.

Pin 19: Reference power supply bypass capacitors (C<sub>18</sub> and C<sub>19</sub>)

Connect the low-frequency bypass capacitor (C<sub>18</sub>) and the high-frequency bypass capacitor (C<sub>19</sub>).

Pin 20: AM oscillator coil (L<sub>4</sub>)

To improve the startup oscillation characteristics, a 100Ω resistor (built-in) is connected in series with the coil. If the shortwave oscillation startup characteristics are poor, connect an additional resistor (47Ω to 100Ω) in series with the coil. Make the earth point for the oscillator coil pin 19 (V<sub>reg</sub>). The relationship between the S/N ratio and sensitivity at 20dB S/N against pin 20 oscillation voltage is shown in Fig. 11.

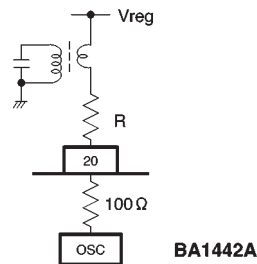

Fig. 10

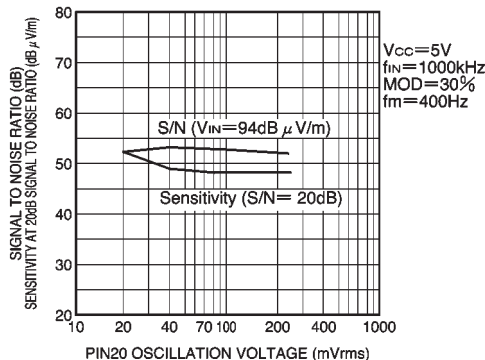

Fig. 11 S / N ratio and sensitivity pin 20 oscillation voltage

Pin 6: AFC circuit

It is possible to use the pin 6 detector output DC voltage and apply AFC. Fig. 12 shows an application example where the BA4424N is used as the FM front end.

Even if you will not use AFC, when recovering the sub-carrier phase-modulated composite signal (voice-multiplexed TV) in the next stage, match the oscillator and "S" curve orientations in the same way as described above. If they are reversed, the left and right channels of the recovered audio will be reversed.

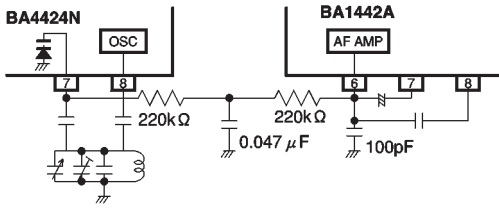

Fig.12

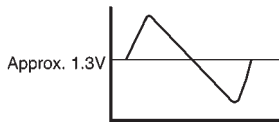

Fig. 13 BA1442A

● Quiescent pin voltages ( $V_{CC} = 5V$ )

Pin	FM	AM
1	2.1	2.1
2	2.1	2.1
3	5.0	5.0
4	5.0	5.0
5	0	0
6	1.3	1.3
7	2.1	2.1
8	2.1	2.1
9	2.1	2.1
10	—	—

Pin	FM	AM
11	1.5	1.5
12	1.5	1.5
13	1.2	4.85
14	2.1	2.1
15	2.1	2.0
16	1.2	4.85
17	5.0	5.0
18	2.1	2.1
19	2.1	2.1
20	2.1	2.1

(Units: V)

● Electrical characteristic curves

MW characteristics

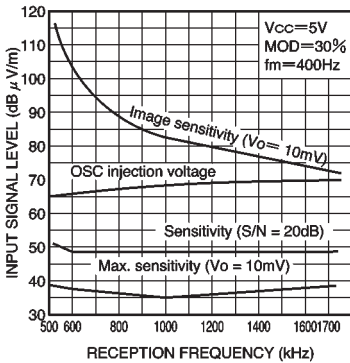

Fig. 14 Tracking characteristics

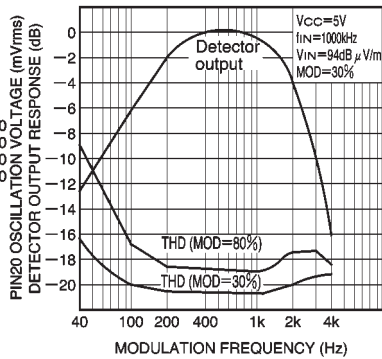

Fig. 15 Fidelity characteristics

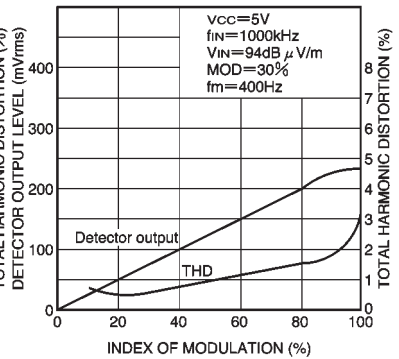

Fig. 16 Modulation characteristics

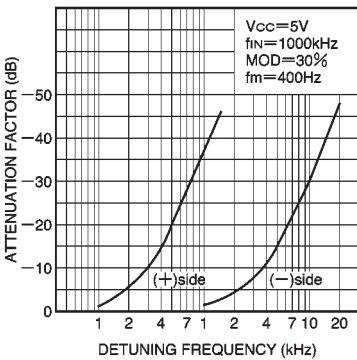

Fig. 17 Selectivity characteristics

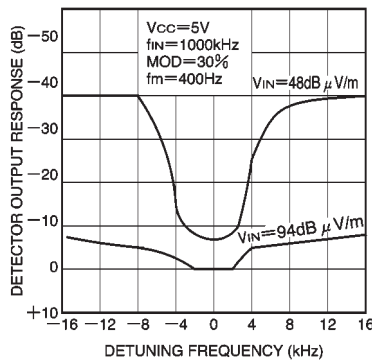

Fig. 18 Detuning characteristics

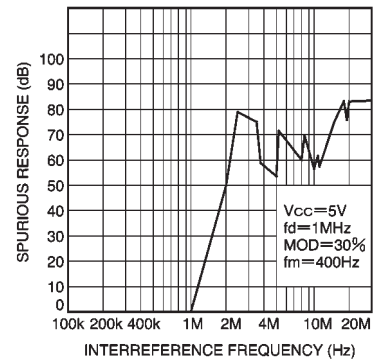

Fig. 19 Spurious response characteristics

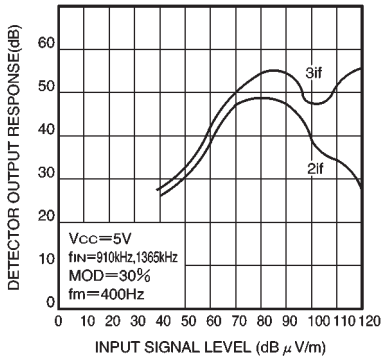

Fig. 20 Beat characteristics

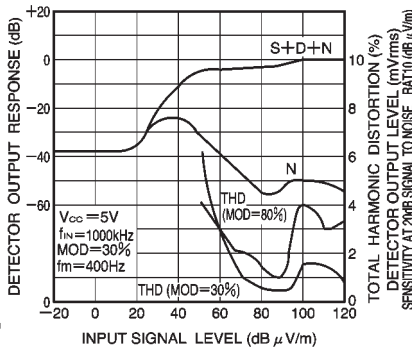

Fig. 21 Sensitivity characteristics

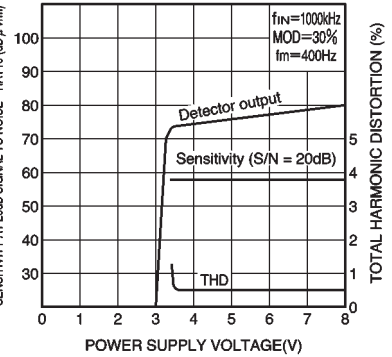

Fig. 22 Power supply voltage characteristics

FM characteristics

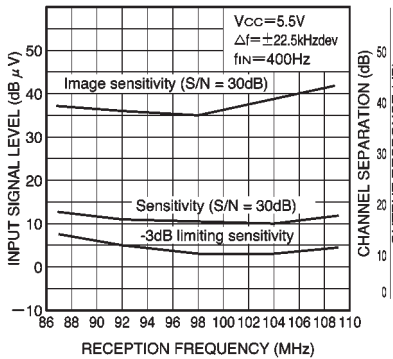

Fig. 23 Tracking characteristics

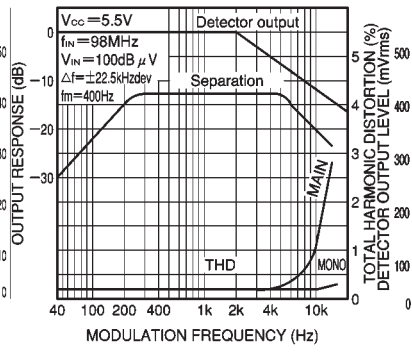

Fig. 24 Fidelity characteristics

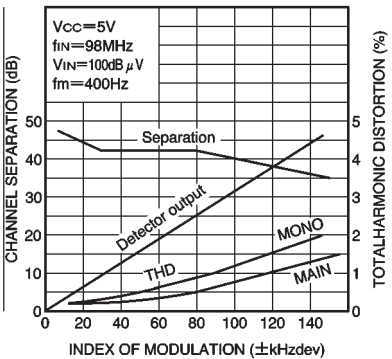

Fig. 25 Modulation characteristics

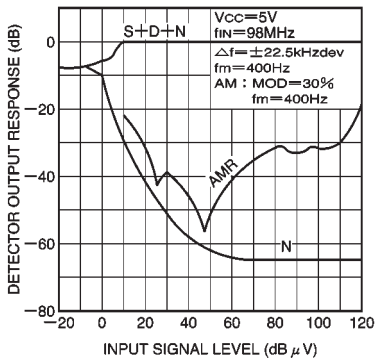

Fig. 26 Sensitivity and AMR characteristics

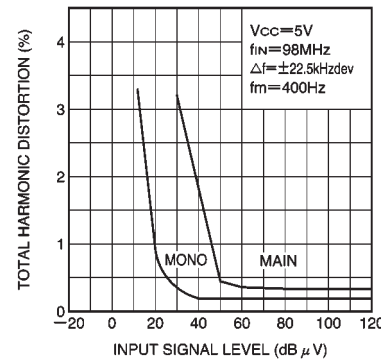

Fig. 27 Sensitivity characteristics

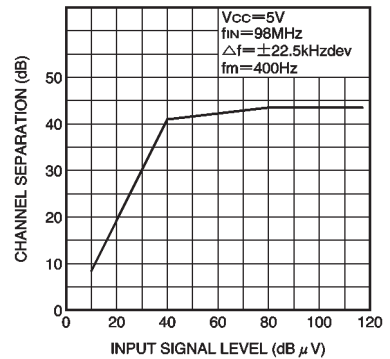

Fig. 28 Sensitivity characteristics

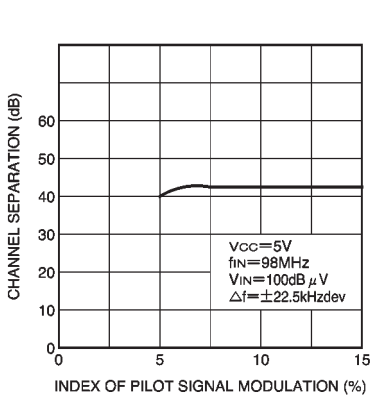

Fig. 29 Pilot fluctuation characteristics

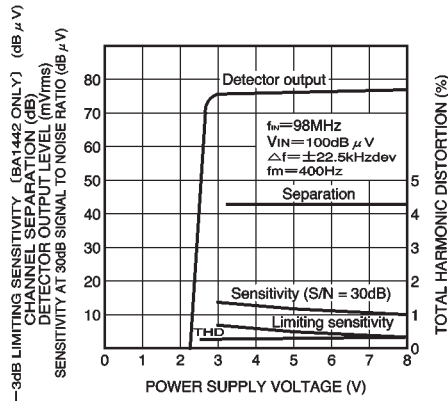
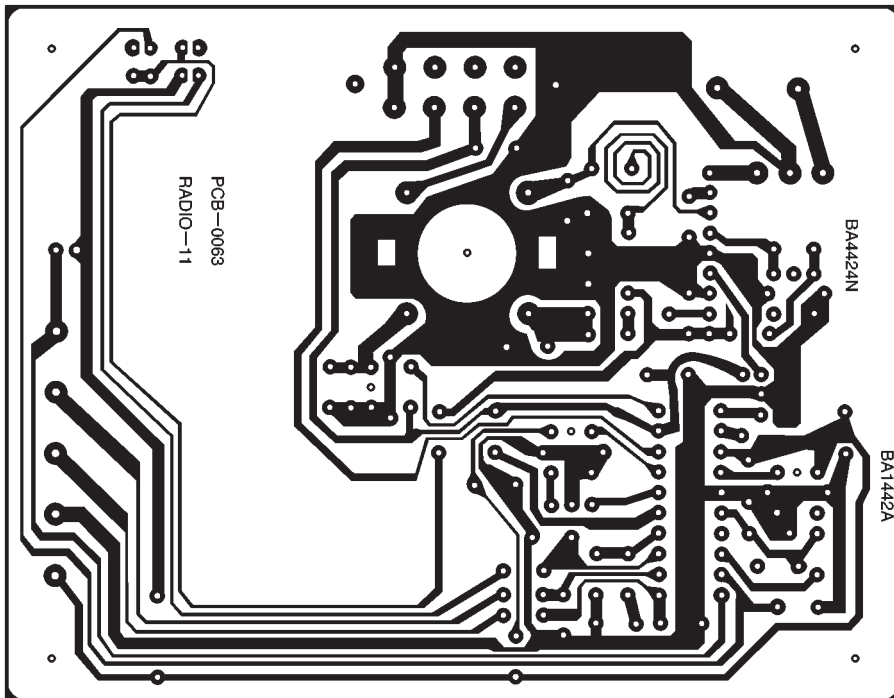

Fig. 30 Power supply voltage characteristics

● Application board



Solder side



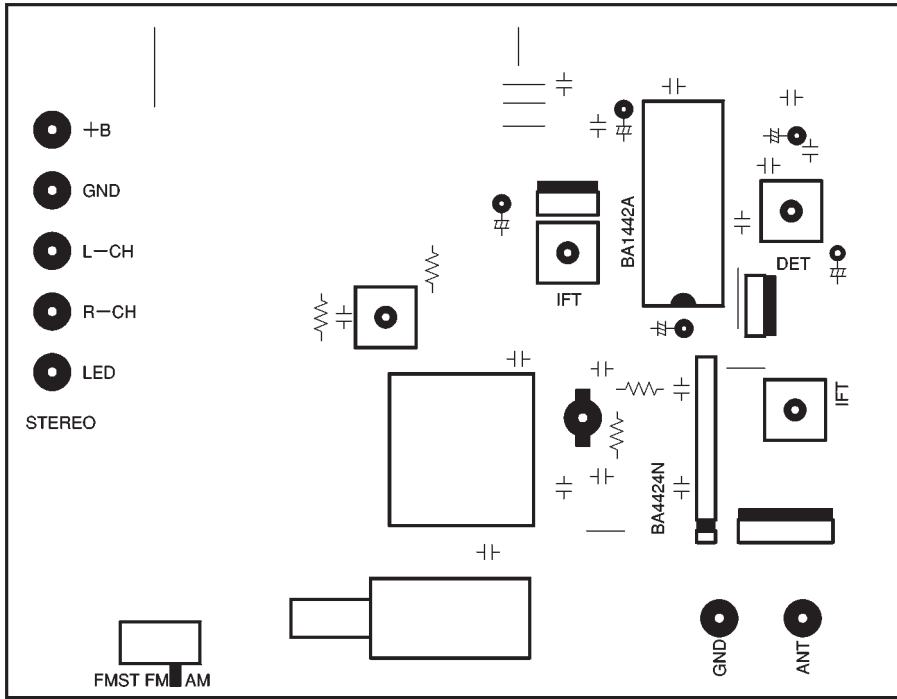

Component side

● External dimensions (Units: mm)

