

**1SV298**

Silicon Epitaxial PIN Diode

 π Type Attenuator Applications**Features**

- Composite type with 3 diodes contained in the CP package currently in use, improving the mounting efficiency greatly.
- Small interterminal capacitance ($C=0.23\text{pF}$ typ).
- Small forward series resistance ($r_s=7.5\Omega$ typ).

Package Dimensions

unit:mm

1269

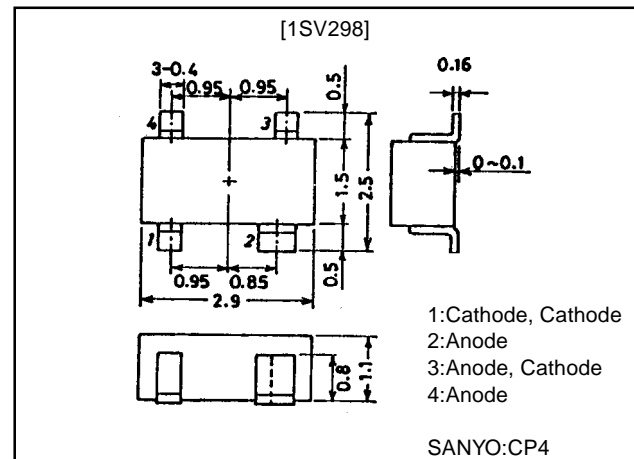
**Specifications****Absolute Maximum Ratings at $T_a = 25^\circ\text{C}$**

Parameter	Symbol	Conditions	Ratings	Unit
Reverse Voltage	V_R		50	V
Forward Current	I_F		50	mA
Allowable Power Dissipation	P		150	mW
Junction Temperature	T_j		125	$^\circ\text{C}$
Storage Temperature	T_{stg}		-55 to +125	$^\circ\text{C}$

Electrical Characteristics at $T_a = 25^\circ\text{C}$

Parameter	Symbol	Conditions	Ratings			Unit
			min	typ	max	
Reverse Voltage	V_R	$I_R=10\mu\text{A}$	50			V
Reverse Current	I_R	$V_R=50\text{V}$			0.1	μA
Forward Voltage	V_F	$I_F=50\text{mA}$		0.975	1.15	V
Interterminal Capacitance	C	$V_R=50\text{V}$, $f=1\text{MHz}$		0.23		pF
Series Resistance	r_s	$I_F=10\mu\text{A}$, $f=100\text{MHz}$		2400		Ω
		$I_F=10\text{mA}$, $f=100\text{MHz}$	6.5	7.5	10.0	Ω

Note : The specifications shown above are for each individual diode.

· Marking:QV

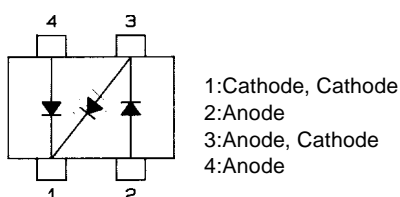
Electrical Connection**SANYO Electric Co.,Ltd. Semiconductor Business Headquarters**

TOKYO OFFICE Tokyo Bldg., 1-10, 1 Chome, Ueno, Taito-ku, TOKYO, 110-8534 JAPAN

52098HA (KT)/D2695GI/82595GI (KOTO) TA-0683, TA-0520 No.5224-1/3

1SV298

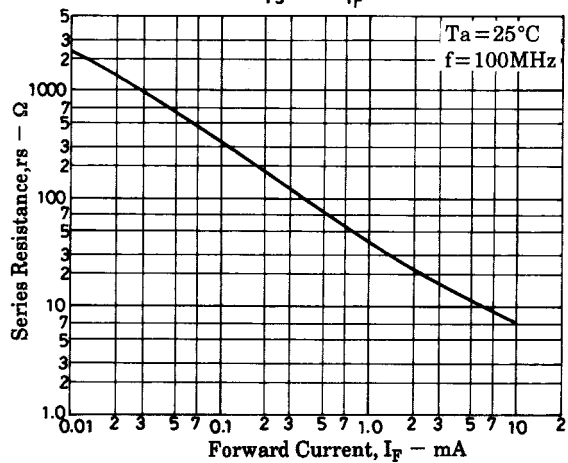
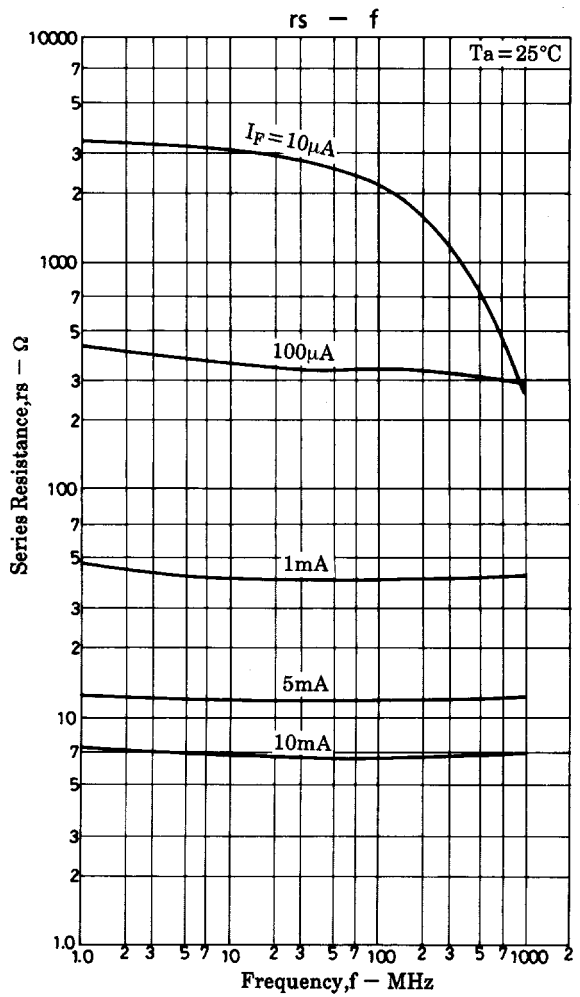
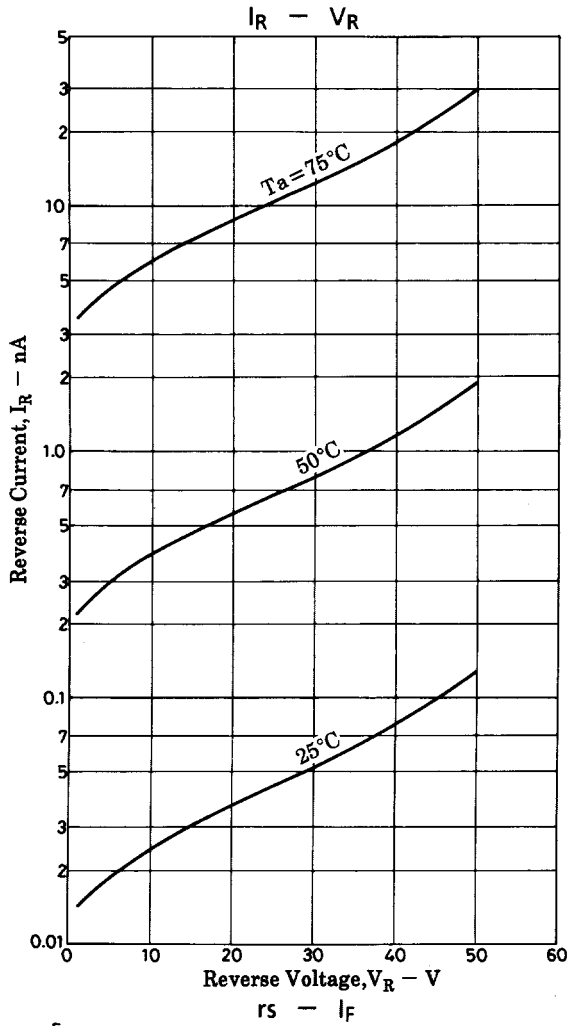
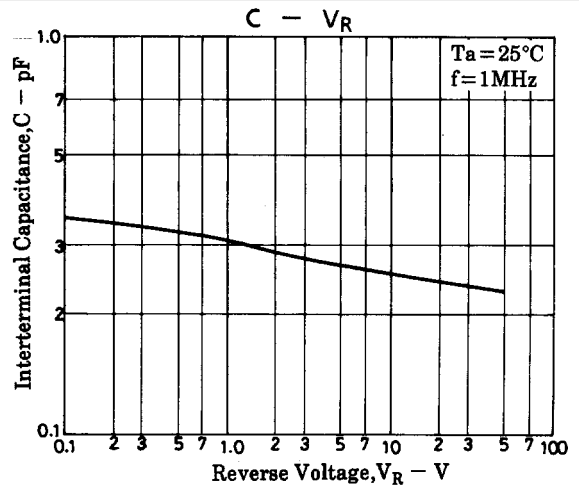
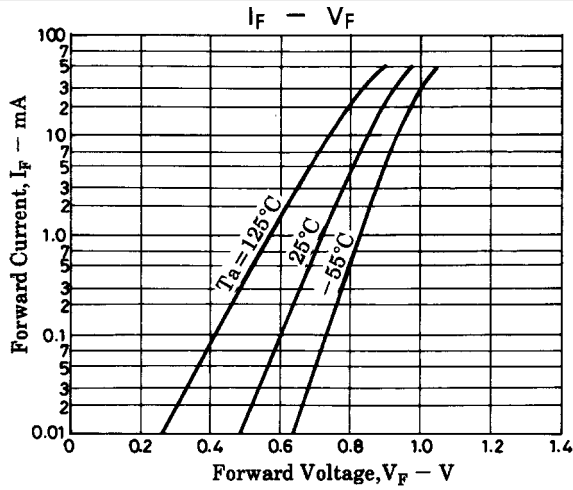

- No products described or contained herein are intended for use in surgical implants, life-support systems, aerospace equipment, nuclear power control systems, vehicles, disaster/crime-prevention equipment and the like, the failure of which may directly or indirectly cause injury, death or property loss.
- Anyone purchasing any products described or contained herein for an above-mentioned use shall:
 - ① Accept full responsibility and indemnify and defend SANYO ELECTRIC CO., LTD., its affiliates, subsidiaries and distributors and all their officers and employees, jointly and severally, against any and all claims and litigation and all damages, cost and expenses associated with such use:
 - ② Not impose any responsibility for any fault or negligence which may be cited in any such claim or litigation on SANYO ELECTRIC CO., LTD., its affiliates, subsidiaries and distributors or any of their officers and employees jointly or severally.
- Information (including circuit diagrams and circuit parameters) herein is for example only; it is not guaranteed for volume production. SANYO believes information herein is accurate and reliable, but no guarantees are made or implied regarding its use or any infringements of intellectual property rights or other rights of third parties.

This catalog provides information as of May, 1998. Specifications and information herein are subject to change without notice.