

Product Summary

Part Number	V _{GS(off)} (V)	r _{DS(on)} Max (Ω)	I _{D(off)} Typ (pA)	t _{ON} Typ (ns)
J105	-4.5 to -10	3	10	14
J106	-2 to -6	6	10	14
J107	-0.5 to -4.5	8	10	14

Features

- Low On-Resistance: J105 < 3 Ω
- Fast Switching—t_{ON}: 14 ns
- Low Leakage: 10 pA
- Low Capacitance: 20 pF
- Low Insertion Loss

Benefits

- Low Error Voltage
- High-Speed Analog Circuit Performance
- Negligible “Off-Error,” Excellent Accuracy
- Good Frequency Response
- Eliminates Additional Buffering

Applications

- Analog Switches
- Choppers
- Sample-and-Hold
- Normally “On” Switches
- Current Limiters

Description

The J105/106/107 are high-performance JFET analog switches designed to offer low on-resistance and fast switching. r_{DS(on)} < 3 Ω is guaranteed for the J105 making this device the lowest of any commercially available JFET.

The low cost TO-226AA (TO-92) plastic package is available in a wide range of tape-and-reel options (see Packaging Information). For similar products in TO-206AC (TO-52) packaging, see the U290/291 data sheet.

TO-226AA
(TO-92)

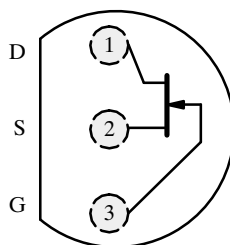

Top View

Absolute Maximum Ratings

Gate-Drain, Gate-Source Voltage -25 V
 Gate Current 50 mA
 Storage Temperature -55 to 150°C
 Operating Junction Temperature -55 to 150°C

Power Dissipation^a 350 mW

Notes

a. Derate 2.8 mW/°C above 25°C

Specifications^a

Parameter	Symbol	Test Conditions	Typ ^b	Limits						Unit
				J105		J106		J107		
				Min	Max	Min	Max	Min	Max	
Static										
Gate-Source Breakdown Voltage	$V_{(BR)GSS}$	$I_G = -1 \mu A, V_{DS} = 0 V$	-35	-25		-25		-25		V
Gate-Source Cutoff Voltage	$V_{GS(off)}$	$V_{DS} = 5 V, I_D = 1 \mu A$		-4.5	-10	-2	-6	-0.5	-4.5	
Saturation Drain Current ^c	I_{DSS}	$V_{DS} = 15 V, V_{GS} = 0 V$		500		200		100		mA
Gate Reverse Current	I_{GSS}	$V_{GS} = -15 V, V_{DS} = 0 V$ $T_A = 125^\circ C$	-0.02		-3		-3		-3	nA
			-10							
Gate Operating Current ^c	I_G	$V_{DG} = 10 V, I_D = 25 mA$	-0.01							
Drain Cutoff Current	$I_{D(off)}$	$V_{DS} = 5 V, V_{GS} = -10 V$ $T_A = 125^\circ C$	0.01		3		3		3	nA
			5							
Drain-Source On-Resistance	$r_{DS(on)}$	$V_{GS} = 0 V, I_D = 1 mA$			3		6		8	Ω
Gate-Source Forward Voltage	$V_{GS(F)}$	$I_G = 1 mA, V_{DS} = 0 V$	0.7							V
Dynamic										
Common-Source Forward Transconductance ^c	g_{fs}	$V_{DS} = 10 V, I_D = 25 mA$ $f = 1 kHz$	55							mS
	g_{os}		5							
Drain-Source On-Resistance	$r_{ds(on)}$	$V_{GS} = 0 V, I_D = 0 mA, f = 1 kHz$			3		6		8	Ω
Common-Source Input Capacitance	C_{iss}	$V_{DS} = 0 V, V_{GS} = 0 V, f = 1 MHz$	120		160		160		160	pF
Common-Source Reverse Transfer Capacitance	C_{rss}	$V_{DS} = 0 V, V_{GS} = -10 V$ $f = 1 MHz$	20		35		35		35	
Equivalent Input Noise Voltage	\bar{e}_n	$V_{DG} = 10 V, I_D = 25 mA$ $f = 1 kHz$	3							nV/\sqrt{Hz}
Switching										
Turn-On Time	$t_{d(on)}$	$V_{DD} = 1.5 V, V_{GS(H)} = 0 V$ See Switching Diagram	6							ns
	t_r		8							
Turn-Off Time	$t_{d(off)}$		5							
	t_f		9							

Notes

- $T_A = 25^\circ C$ unless otherwise noted.
- Typical values are for DESIGN AID ONLY, not guaranteed nor subject to production testing.
- Pulse test: $PW \leq 300 \mu s$ duty cycle $\leq 3\%$.

NVA

Typical Characteristics

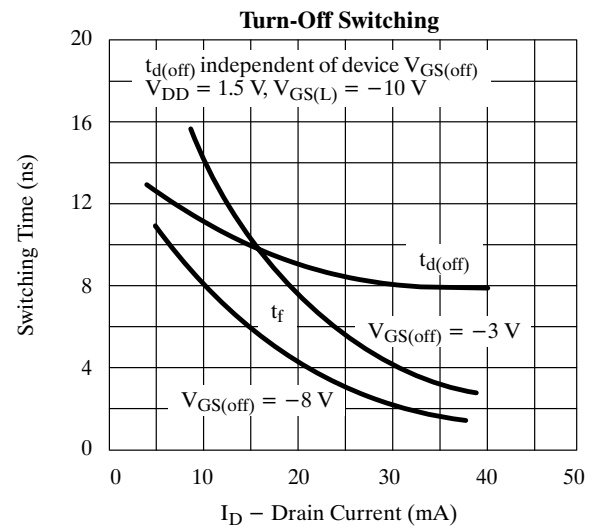
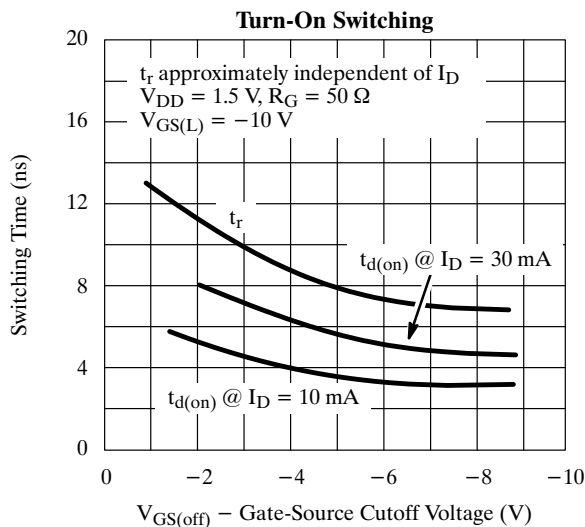
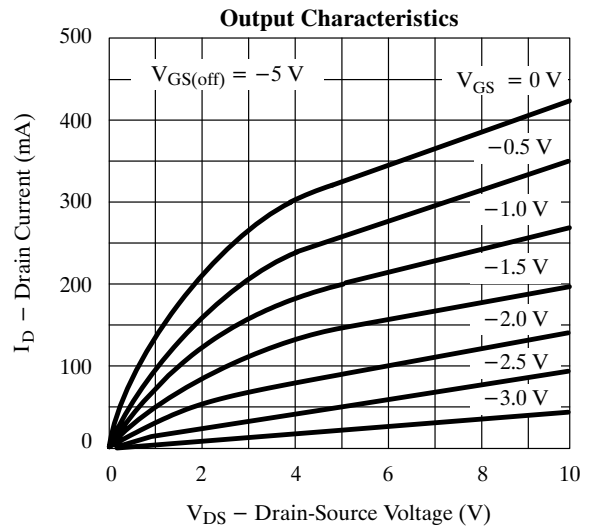
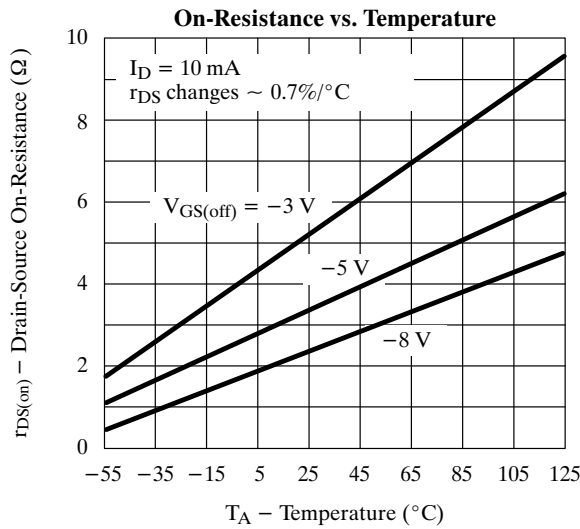
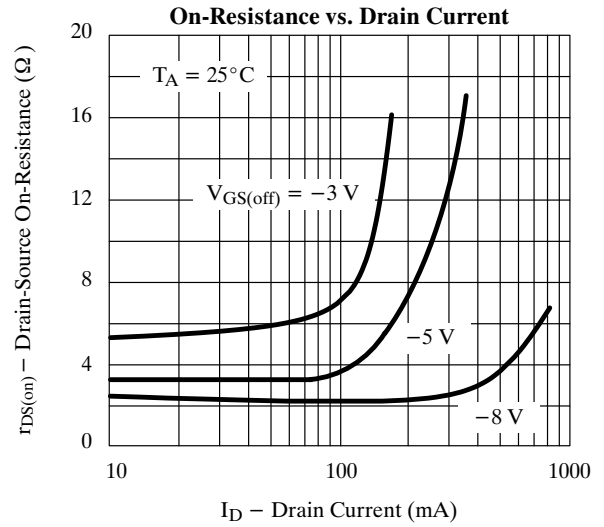
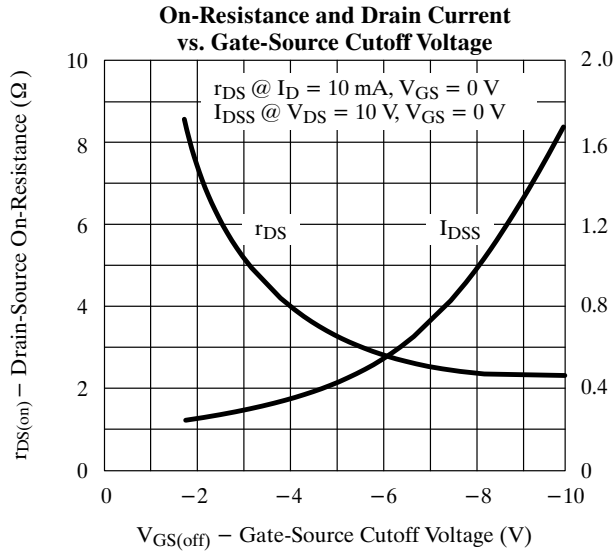

Typical Characteristics (Cont'd)

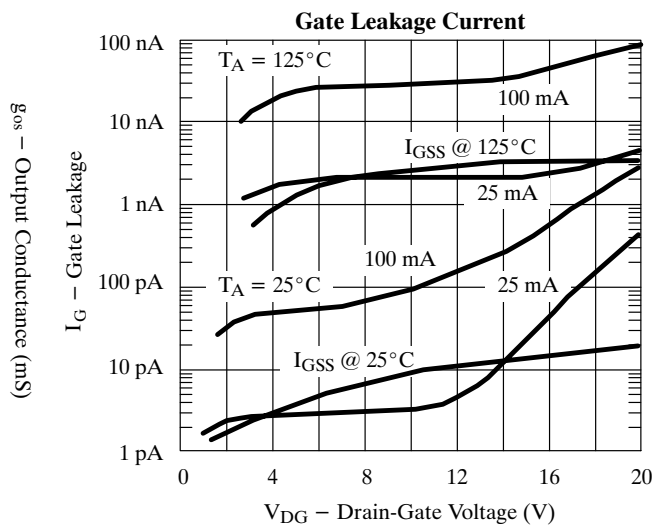
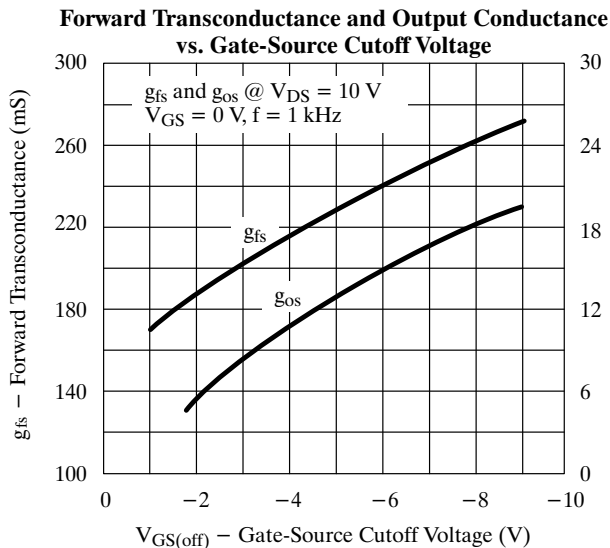
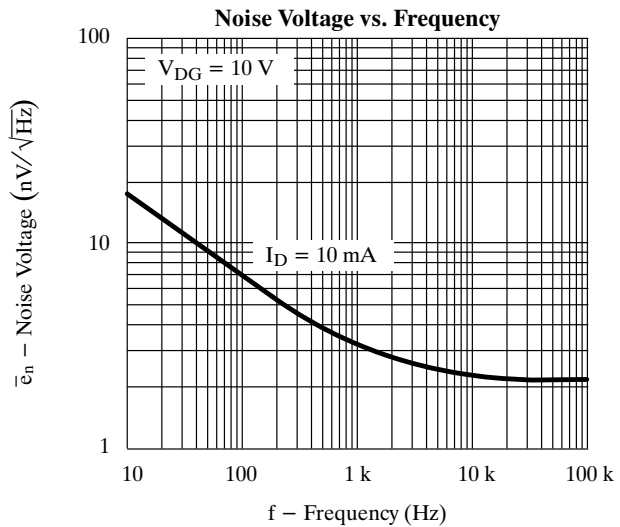
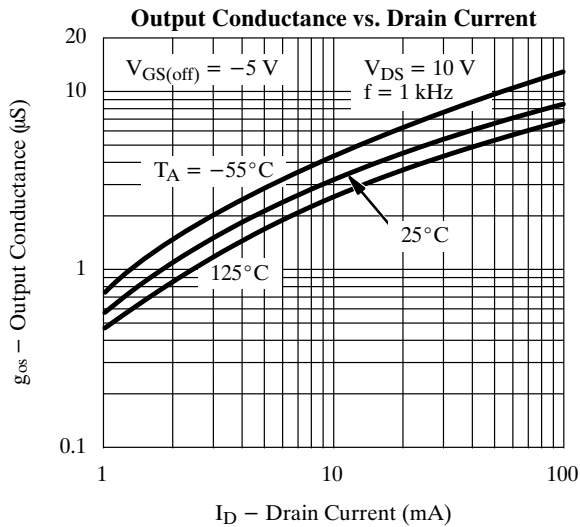
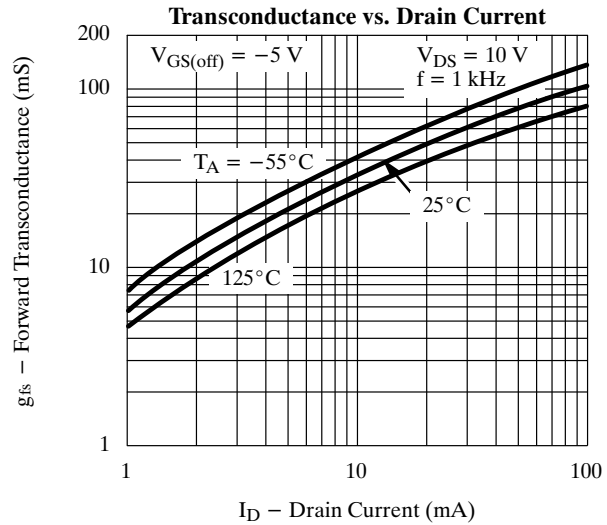
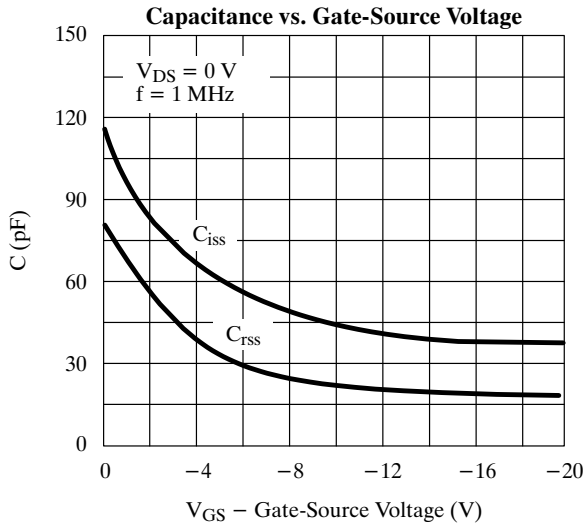

Switching Time Test Circuit

	J105	J106	J107
$V_{GS(L)}$	-12V	-7V	-5V
R_L	50 Ω	50 Ω	50 Ω
$I_{D(on)}$	28 mA	27 mA	26 mA

*Non-inductive

Input Pulse

Rise Time < 1 ns
 Fall Time < 1 ns
 Pulse Width 100 ns
 PRF 1 MHz

Sampling Scope

Rise Time 0.4 ns
 Input Resistance 10 M Ω
 Input Capacitance 1.5 pF

