

LM556

Dual Timer

General Description

The LM556 Dual timing circuit is a highly stable controller capable of producing accurate time delays or oscillation. The 556 is a dual 555. Timing is provided by an external resistor and capacitor for each timing function. The two timers operate independently of each other sharing only V_{CC} and ground. The circuits may be triggered and reset on falling waveforms. The output structures may sink or source 200mA.

Features

- n Direct replacement for SE556/NE556
- n Timing from microseconds through hours
- n Operates in both astable and monostable modes
- n Replaces two 555 timers
- n Adjustable duty cycle
- n Output can source or sink 200mA
- n Output and supply TTL compatible
- n Temperature stability better than 0.005% per °C
- n Normally on and normally off output

Applications

- n Precision timing
- n Pulse generation
- n Sequential timing
- n Time delay generation
- n Pulse width modulation
- n Pulse position modulation
- n Linear ramp generator

Connection Diagram

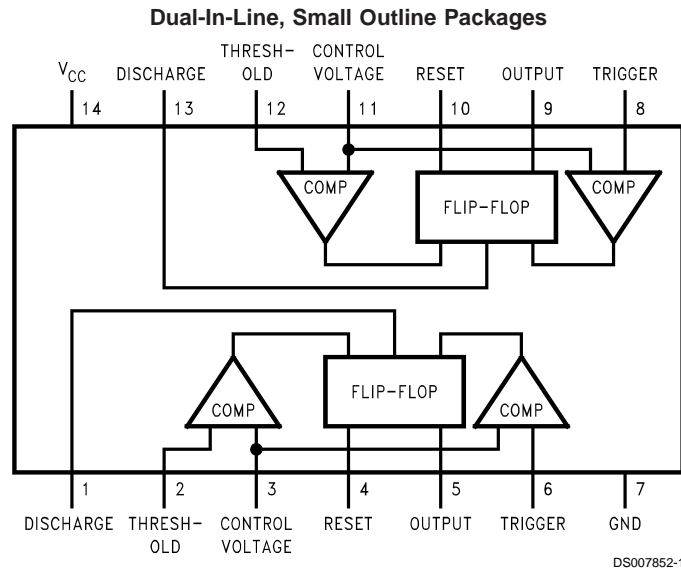

Top View

Ordering Information

Package	Part Number	Package Marking	Media Transport	NSC Drawing
14-Pin SOIC	LM556CM	LM556CM	Rails	M14A
	LM556CMX	LM556CM	2.5k Units Tape and Reel	
14-Pin MDIP	LM556CN	LM556CN	Rails	N14a

Schematic Diagram

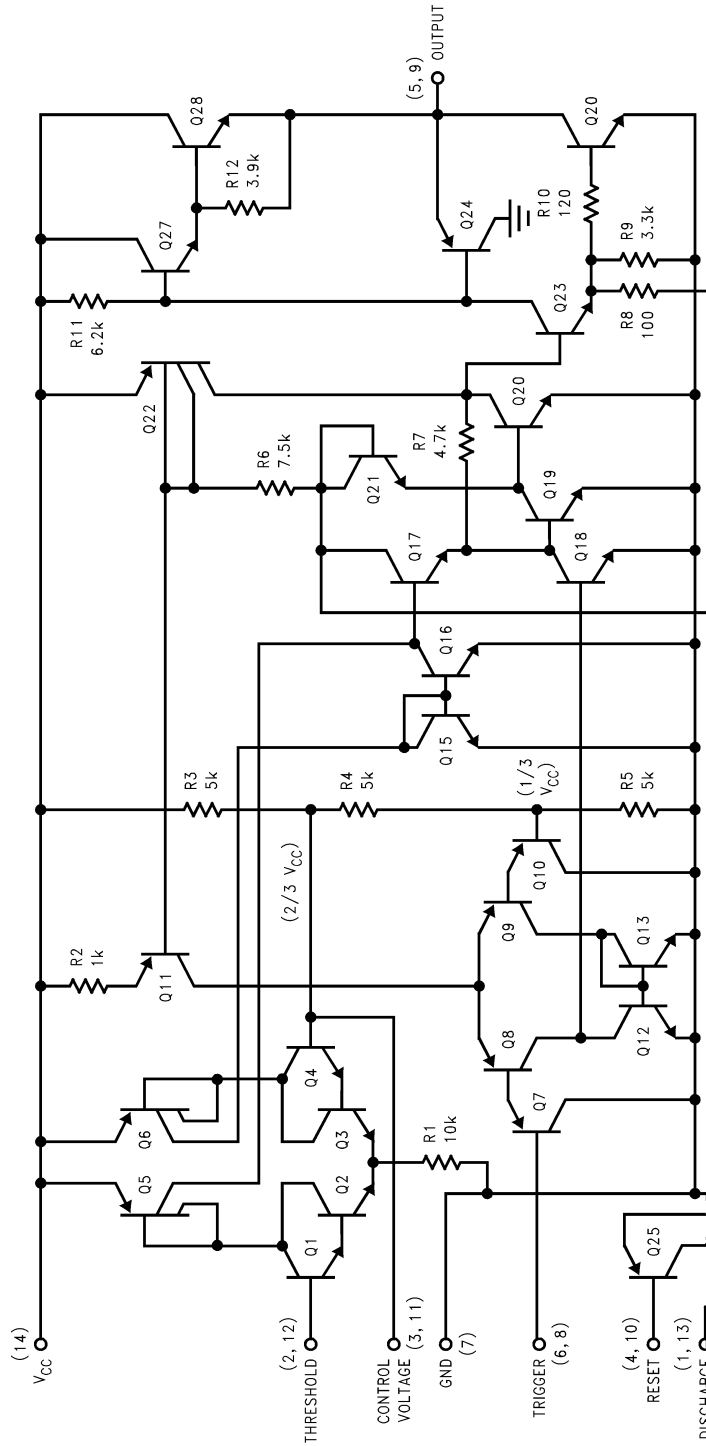

DS007852-2

Absolute Maximum Ratings (Note 1)

If Military/Aerospace specified devices are required, please contact the National Semiconductor Sales Office/Distributors for availability and specifications.

Supply Voltage	+18V
Power Dissipation (Note 2)	
LM556CM	410 mW
LM556CN	1620 mW
Operating Temperature Ranges	
LM556C	0°C to +70°C

Storage Temperature Range –65°C to +150°C

Soldering Information

Dual-In-Line Package	
Soldering (10 Seconds)	260°C
Small Outline Packages	
Vapor Phase (60 Seconds)	215°C
Infrared (15 Seconds)	220°C

See AN-450 "Surface Mounting Methods and Their Effect on Product Reliability" for other methods of soldering surface mount devices.

Electrical Characteristics(T_A = 25°C, V_{CC} = +5V to +15V, unless otherwise specified)

Parameter	Conditions	Limits			Units
		LM556C			
		Min	Typ	Max	
Supply Voltage		4.5		16	V
Supply Current (Each Timer Section)	V _{CC} = 5V, R _L = ∞ V _{CC} = 15V, R _L = ∞ (Low State) (Note 3)		3 10	6 14	mA
Timing Error, Monostable					
Initial Accuracy			0.75		%
Drift with Temperature	R _A = 1k to 100kΩ, C = 0.1μF, (Note 4)		50		ppm/°C
Accuracy over Temperature			1.5		%
Drift with Supply			0.1		%/V
Timing Error, Astable					
Initial Accuracy			2.25		%
Drift with Temperature	R _A , R _B = 1k to 100kΩ, C = 0.1μF, (Note 4)		150		ppm/°C
Accuracy over Temperature			3.0		%
Drift with Supply			0.30		%/V
Trigger Voltage	V _{CC} = 15V V _{CC} = 5V	4.5 1.25	5 1.67	5.5 2.0	V V
Trigger Current			0.2	1.0	μA
Reset Voltage		0.4	0.5	1	V
Reset Current			0.1	0.6	mA
Threshold Current	V _{TH} = V-Control (Note 6) V _{TH} = 11.2V		0.03	0.1 250	μA nA
Control Voltage Level and Threshold Voltage	V _{CC} = 15V V _{CC} = 5V	9 2.6	10 3.33	11 4	V V
Pin 1, 13 Leakage Output High			1	100	nA
Pin 1, 13 Sat	(Note 7)				
Output Low	V _{CC} = 15V, I = 15mA		180	300	mV
Output Low	V _{CC} = 4.5V, I = 4.5mA		80	200	mV
Output Voltage Drop (Low)	V _{CC} = 15V I _{SINK} = 10mA I _{SINK} = 50mA I _{SINK} = 100mA I _{SINK} = 200mA V _{CC} = 5V I _{SINK} = 8mA I _{SINK} = 5mA		0.1 0.4 2 2.5	0.25 0.75 2.75	V V V V
			0.25	0.35	V

Electrical Characteristics (Continued)

($T_A = 25^\circ\text{C}$, $V_{CC} = +5\text{V}$ to $+15\text{V}$, unless otherwise specified)

Parameter	Conditions	Limits			Units
		LM556C			
		Min	Typ	Max	
Output Voltage Drop (High)	$I_{\text{SOURCE}} = 200\text{mA}$, $V_{CC} = 15\text{V}$		12.5		V
	$I_{\text{SOURCE}} = 100\text{mA}$, $V_{CC} = 15\text{V}$	12.75	13.3		V
	$V_{CC} = 5\text{V}$	2.75	3.3		V
Rise Time of Output			100		ns
Fall Time of Output			100		ns
Matching Characteristics	(Note 8)				
Initial Timing Accuracy			0.1	2.0	%
Timing Drift with Temperature			± 10		ppm/ $^\circ\text{C}$
Drift with Supply Voltage			0.2	0.5	%/V

Note 1: Absolute Maximum Ratings indicate limits beyond which damage to the device may occur.

Note 2: For operating at elevated temperatures the device must be derated based on a $+150^\circ\text{C}$ maximum junction temperature and a thermal resistance of 77°C/W (Plastic Dip), and 110°C/W (SO-14 Narrow).

Note 3: Supply current when output high typically 1mA less at $V_{CC} = 5\text{V}$.

Note 4: Tested at $V_{CC} = 5\text{V}$ and $V_{CC} = 15\text{V}$.

Note 5: As reset voltage lowers, timing is inhibited and then the output goes low.

Note 6: This will determine the maximum value of $R_A + R_B$ for 15V operation. The maximum total ($R_A + R_B$) is 20 M Ω .

Note 7: No protection against excessive pin 1, 13 current is necessary providing the package dissipation rating will not be exceeded.

Note 8: Matching characteristics refer to the difference between performance characteristics of each timer section.

Note 9: Refer to RETS556X drawing of military LM556J versions.

Typical Performance Characteristics

Minimum Pulse Width Required for Triggering

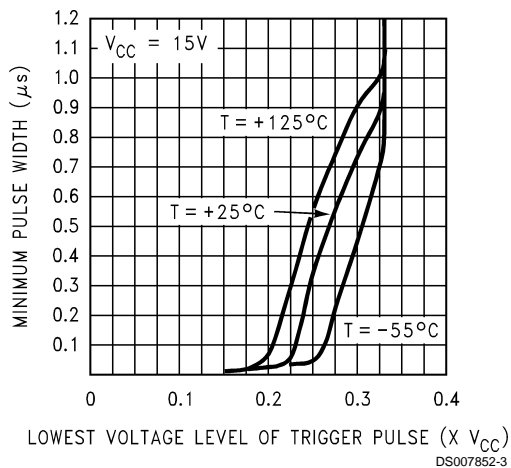

Supply Current vs. Supply Voltage (Each Section)

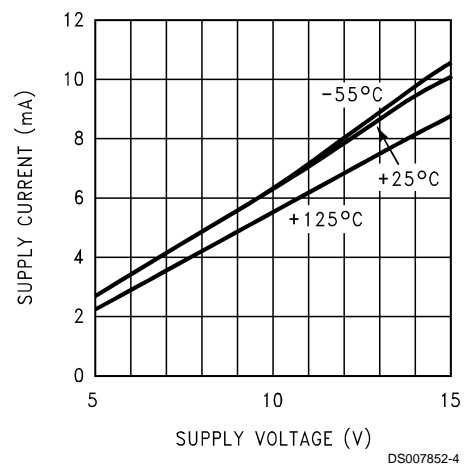

Typical Performance Characteristics (Continued)

High Output Voltage vs. Output Source Current

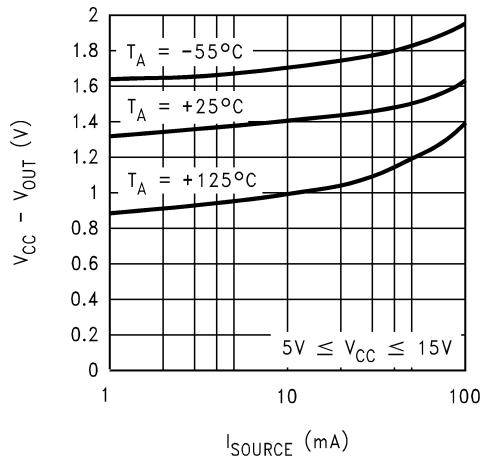

DS007852-5

Low Output Voltage vs. Output Sink Current

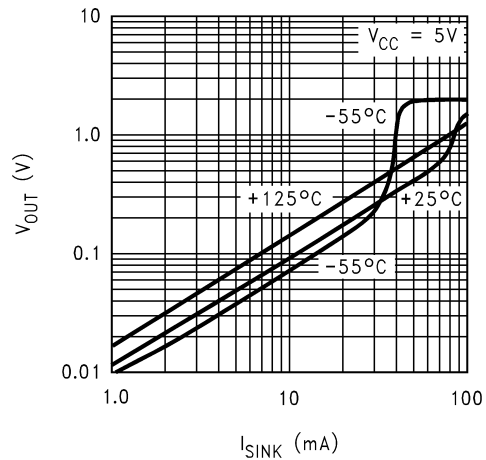

DS007852-6

Low Output Voltage vs. Output Sink Current

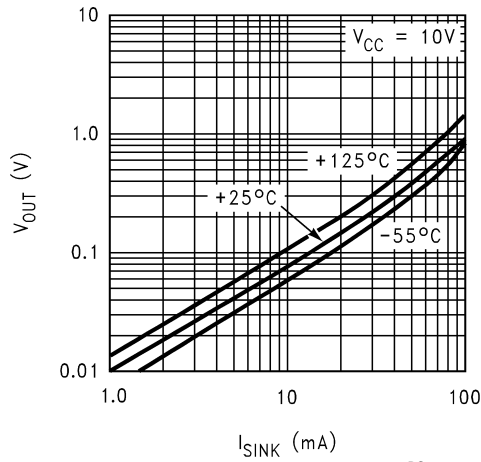

DS007852-7

Low Output Voltage vs. Output Sink Current

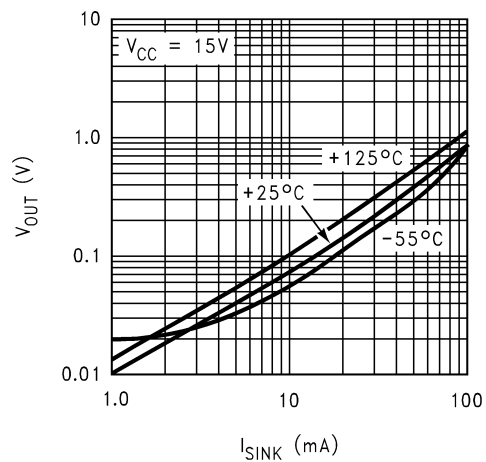

DS007852-8

Output Propagation Delay vs. Voltage Level of Trigger Pulse

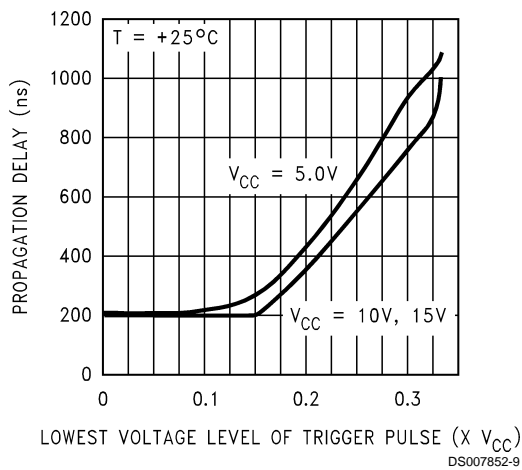

DS007852-9

Output Propagation Delay vs. Voltage Level of Trigger Pulse

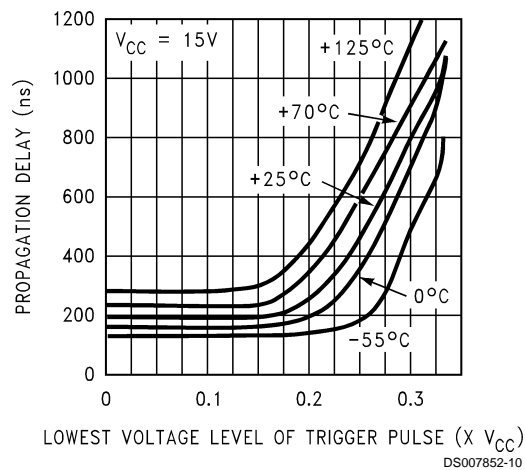

DS007852-10

Typical Performance Characteristics (Continued)

Discharge Transistor (Pin 1, 13) Voltage vs. Sink Current

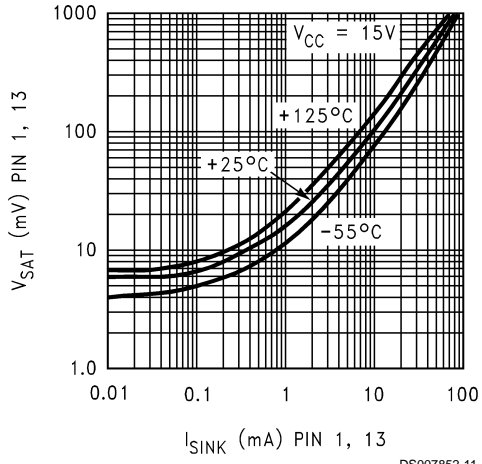

Discharge Transistor (Pin 1, 13) Voltage vs. Sink Current

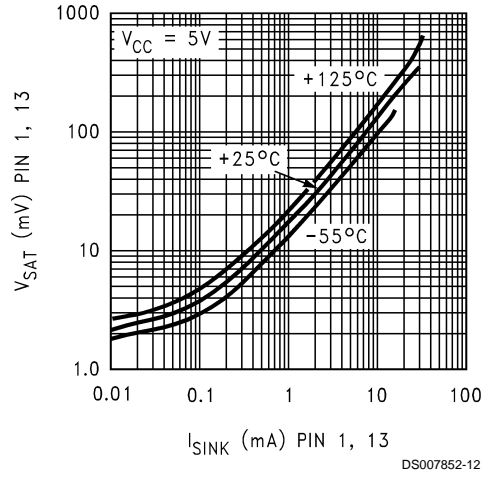

Physical Dimensions inches (millimeters) unless otherwise noted

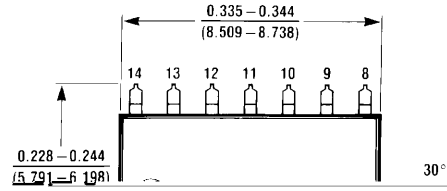

**Small Outline Package (M)
NS Package Number M14A**

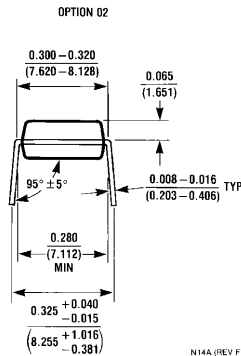
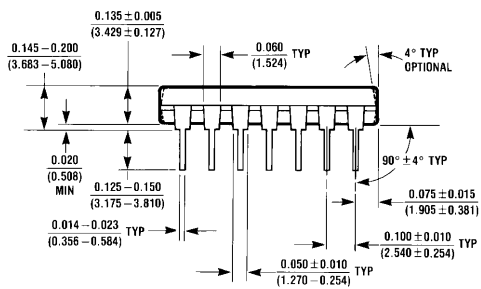
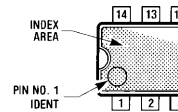
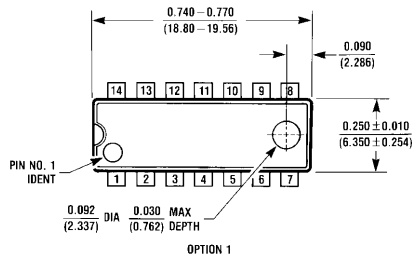

**14-Lead (0.118" Wide) Molded Mini Small Outline Package
NS Package Number N14A**

Notes

LIFE SUPPORT POLICY

NATIONAL'S PRODUCTS ARE NOT AUTHORIZED FOR USE AS CRITICAL COMPONENTS IN LIFE SUPPORT DEVICES OR SYSTEMS WITHOUT THE EXPRESS WRITTEN APPROVAL OF THE PRESIDENT AND GENERAL COUNSEL OF NATIONAL SEMICONDUCTOR CORPORATION. As used herein:

1. Life support devices or systems are devices or systems which, (a) are intended for surgical implant into the body, or (b) support or sustain life, and whose failure to perform when properly used in accordance with instructions for use provided in the labeling, can be reasonably expected to result in a significant injury to the user.
2. A critical component is any component of a life support device or system whose failure to perform can be reasonably expected to cause the failure of the life support device or system, or to affect its safety or effectiveness.



National Semiconductor Corporation
Americas
Tel: 1-800-272-9959
Fax: 1-800-737-7018
Email: support@nsc.com
www.national.com

National Semiconductor Europe
Fax: +49 (0) 180-530 85 86
Email: europe.support@nsc.com
Deutsch Tel: +49 (0) 69 9508 6208
English Tel: +44 (0) 870 24 0 2171
Français Tel: +33 (0) 1 41 91 8790

National Semiconductor Asia Pacific Customer Response Group
Tel: 65-2544466
Fax: 65-2504466
Email: ap.support@nsc.com

National Semiconductor Japan Ltd.
Tel: 81-3-5639-7560
Fax: 81-3-5639-7507