

LM1894 Dynamic Noise Reduction System DNR®

General Description

The LM1894 is a stereo noise reduction circuit for use with audio playback systems. The DNR system is non-complementary, meaning it does not require encoded source material. The system is compatible with virtually all prerecorded tapes and FM broadcasts. Psychoacoustic masking, and an adaptive bandwidth scheme allow the DNR to achieve 10 dB of noise reduction. DNR can save circuit board space and cost because of the few additional components required.

Features

- Non-complementary noise reduction, "single ended"
- Low cost external components, no critical matching

- Compatible with all prerecorded tapes and FM
- 10 dB effective tape noise reduction CCIR/ARM weighted
- Wide supply range, 4.5V to 18V
- 1 Vrms input overload

Applications

- Automotive radio/tape players
- Compact portable tape players
- Quality HI-FI tape systems
- VCR playback noise reduction
- Video disc playback noise reduction

Typical Application

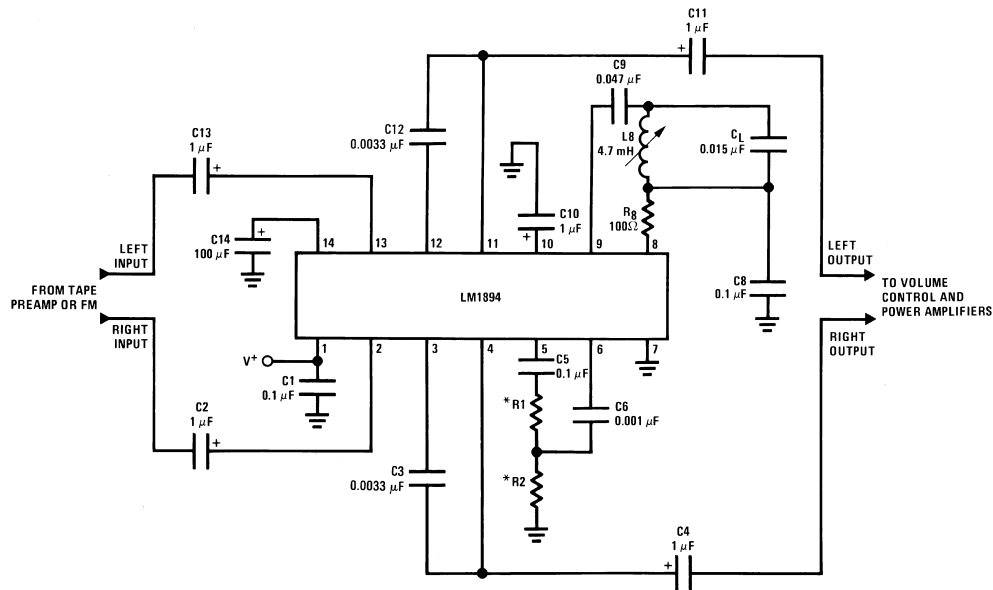

*R1 + R2 = 1 kΩ total.
See Application Hints.

DS007918-1

Order Number LM1894M or LM1894N
See NS Package Number M14A or N14A
FIGURE 1. Component Hook-Up for Stereo DNR System

DNR® is a registered trademark of National Semiconductor Corporation.
The DNR® system is licensed to National Semiconductor Corporation under U.S. patent 3,678,416 and 3,753,159.
Trademark and license agreement required for use of this product.

Absolute Maximum Ratings (Note 1)

If Military/Aerospace specified devices are required, please contact the National Semiconductor Sales Office/Distributors for availability and specifications.

Supply Voltage	20V
Input Voltage Range, V_{pk}	$V_S/2$
Operating Temperature (Note 2)	0°C to +70°C
Storage Temperature	-65°C to +150°C
Soldering Information	
Dual-In-Line Package	
Soldering (10 seconds)	260°C

Small Outline Package

Vapor Phase (60 seconds)	215°C
Infrared (15 seconds)	220°C

See AN-450 "Surface Mounting Methods and Their Effect on Product Reliability" for other methods of soldering surface mount devices.

Note 1: "Absolute Maximum Ratings" indicate limits beyond which damage to the device may occur. Operating Ratings indicate conditions for which the device is functional, but do not guarantee specific performance limits.

Electrical Characteristics

$V_S = 8V$, $T_A = 25^\circ C$, $V_{IN} = 300\text{ mV}$ at 1 kHz, circuit shown in *Figure 1* unless otherwise specified

Parameter	Conditions	Min	Typ	Max	Units
Operating Supply Range		4.5	8	18	V
Supply Current	$V_S = 8V$		17	30	mA
MAIN SIGNAL PATH					
Voltage Gain	DC Ground Pin 9, (Note 3)	-0.9	-1	-1.1	V/V
DC Output Voltage		3.7	4.0	4.3	V
Channel Balance	DC Ground Pin 9	-1.0		1.0	dB
Minimum Balance	AC Ground Pin 9 with 0.1 μF Capacitor, (Note 3)	675	965	1400	Hz
Maximum Bandwidth	DC Ground Pin 9, (Note 3)	27	34	46	kHz
Effective Noise Reduction	CCIR/ARM Weighted, (Note 4)		-10	-14	dB
Total Harmonic Distortion	DC Ground Pin 9		0.05	0.1	%
Input Headroom	Maximum V_{IN} for 3% THD AC Ground Pin 9		1.0		Vrms
Output Headroom	Maximum V_{OUT} for 3% THD DC Ground Pin 9		$V_S - 1.5$		Vp-p
Signal to Noise	BW = 20 Hz–20 kHz, re 300 mV AC Ground Pin 9 DC Ground Pin 9 CCIR/ARM Weighted re 300 mV (Note 5) AC Ground Pin 9 DC Ground Pin 9 CCIR Peak, re 300 mV, (Note 6) AC Ground Pin 9 DC Ground Pin 9		79 77 82 70 77 64		dB dB dB dB dB dB
Input Impedance	Pin 2 and Pin 13	14	20	26	k Ω
Channel Separation	DC Ground Pin 9	-50	-70		dB
Power Supply Rejection	C14 = 100 μF , $V_{RIPPLE} = 500\text{ mVrms}$, f = 1 kHz	-40	-56		dB
Output DC Shift	Reference DVM to Pin 14 and Measuree Output DC Shift from Minimum to Maximum Band- width, (Note 7).		4.0	20	mV
CONTROL SIGNAL PATH					
Summing Amplifier Voltage Gain	Both Channels Driven	0.9	1	1.1	V/V
Gain Amplifier Input Impedance	Pin 6	24	30	39	k Ω
Voltage Gain	Pin 6 to Pin 8	21.5	24	26.5	V/V

Electrical Characteristics (Continued)

$V_S = 8V$, $T_A = 25^\circ C$, $V_{IN} = 300\text{ mV}$ at 1 kHz, circuit shown in *Figure 1* unless otherwise specified

Parameter	Conditions	Min	Typ	Max	Units
CONTROL SIGNAL PATH					
Peak Detector Input Impedance	Pin 9	560	700	840	Ω
Voltage Gain	Pin 9 to Pin 10	30	33	36	V/V
Attack Time	Measured to 90% of Final Value with 10 kHz Tone Burst	300	500	700	μs
Decay Time	Measured to 90% of Final Value with 10 kHz Tone Burst	45	60	75	ms
DC Voltage Range	Minimum Bandwidth to Maximum Bandwidth	1.1		3.8	V

Note 2: For operation in ambient temperature above $25^\circ C$, the device must be derated based on a $150^\circ C$ maximum junction temperature and a thermal resistance of 1) $80^\circ C/W$ junction to ambient for the dual-in-line package, and 2) $105^\circ C/W$ junction to ambient for the small outline package.

Note 3: To force the DNR system into maximum bandwidth, DC ground the input to the peak detector, pin 9. A negative temperature coefficient of $-0.5\%/^\circ C$ on the bandwidth, reduces the maximum bandwidth at increased ambient temperature or higher package dissipation. AC ground pin 9 or pin 6 to select minimum bandwidth. To change minimum and maximum bandwidth, see Application Hints.

Note 4: The maximum noise reduction CCIR/ARM weighted is about 14 dB. This is accomplished by changing the bandwidth from maximum to minimum. In actual operation, minimum bandwidth is not selected, a nominal minimum bandwidth of about 2 kHz gives -10 dB of noise reduction. See Application Hints.

Note 5: The CCIR/ARM weighted noise is measured with a 40 dB gain amplifier between the DNR system and the CCIR weighting filter; it is then input referred.

Note 6: Measured using the Rhode-Schwartz psophometer.

Note 7: Pin 10 is DC forced half way between the maximum bandwidth DC level and minimum bandwidth DC level. An AC 1 kHz signal is then applied to pin 10. Its peak-to-peak amplitude is $V_{DC}(\text{max BW}) - V_{DC}(\text{min BW})$.

Typical Performance Characteristics

Supply Current vs Supply Voltage

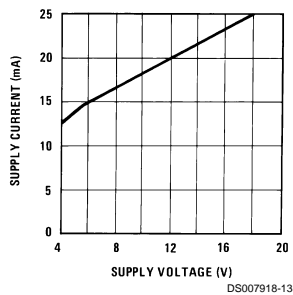

Channel Separation (Referred to the Output) vs Frequency

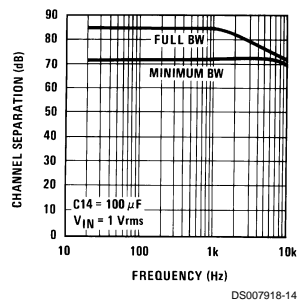

Power Supply Rejection Ratio (Referred to the Output) vs Frequency

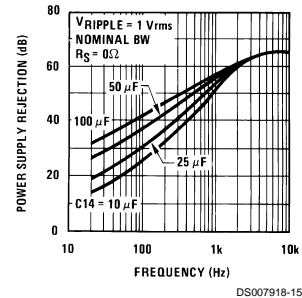

THD vs Frequency

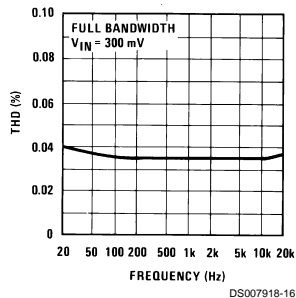

-3 dB Bandwidth vs Frequency and Control Signal

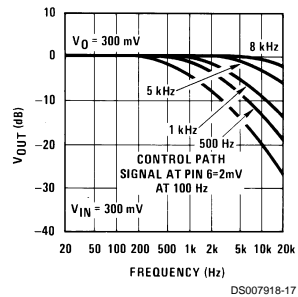

Gain of Control Path vs Frequency (with 10 kHz FM Pilot Filter)

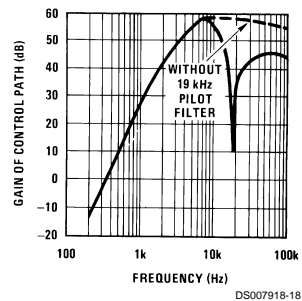

Typical Performance Characteristics (Continued)

**Main Signal Path
Bandwidth vs
Voltage Control**

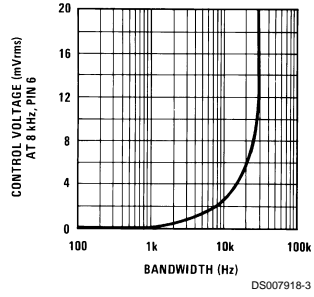

Peak Detector Response

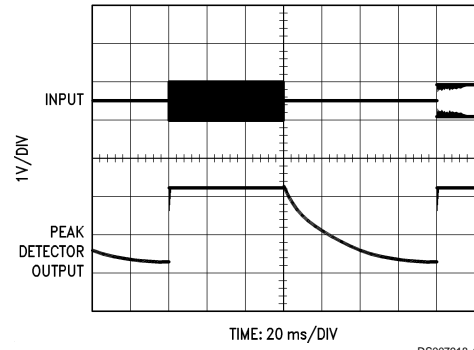

Output Response

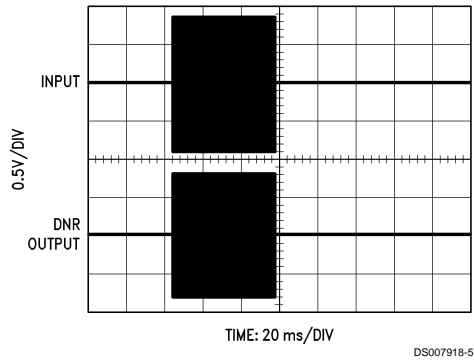

External Component Guide

(Figure 1)

Component	Value	Purpose
C1	0.1 μ F– 100 μ F	May be part of power supply, or may be added to suppress power supply oscillation.
C2, C13	1 μ F	Blocks DC, pin 2 and pin 13 are at DC potential of $V_S/2$. C2, C13 form a low frequency pole with $20k R_{IN}$. $f_L = \frac{1}{2\pi C2 R_{IN}}$
C14	25 μ F– 100 μ F	Improves power supply rejection.
C3, C12	0.0033 μ F	Forms integrator with internal gm block and op amp. Sets bandwidth conversion gain of 33 Hz/ μ A of gm current.
C4, C11	1 μ F	Output coupling capacitor. Output is at DC potential of $V_S/2$.
C5	0.1 μ F	Works with R1 and R2 to attenuate low frequency transients which could disturb control path operation. $f_5 = \frac{1}{2\pi C5 (R1 + R2)} = 1.6 \text{ kHz}$
C6	0.001 μ F	Works with input resistance of pin 6 to form part of control path frequency weighting. $f_6 = \frac{1}{2\pi C6 R_{PIN 6}} = 5.3 \text{ kHz}$
C8	0.1 μ F	Combined with L8 and C_L forms 19 kHz filter for FM pilot. This is only required in FM applications (Note 9).
L8, C_L	4.7 mH, 0.015 μ F	Forms 19 kHz filter for FM pilot. L8 is Toko coil CAN-1A185HM (Notes 8, 9).
C9	0.047 μ F	Works with input resistance of pin 9 to form part of control path frequency weighting. $f_9 = \frac{1}{2\pi C9 R_{PIN 9}} = 4.8 \text{ kHz}$
C10	1 μ F	Set attack and decay time of peak detector.
R1, R2	1 k Ω	Sensitivity resistors set the noise threshold. Reducing attenuation causes larger signals to be peak detected and larger bandwidth in main signal path. Total value of R1 + R2 should equal 1 k Ω .
R8	100 Ω	Forms RC roll-off with C8. This is only required in FM applications.

Note 8: Toko America Inc., 1250 Feehanville Drive, Mt. Prospect IL 60056

Note 9: When FM applications are not required, pin 8 and pin 9 hook-up as follows:

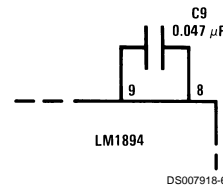

Circuit Operation

The LM1894 has two signal paths, a main signal path and a bandwidth control path. The main path is an audio low pass filter comprised of a gm block with a variable current, and an op amp configured as an integrator. As seen in Figure 2, DC feedback constrains the low frequency gain to $A_V = -1$. Above the cutoff frequency of the filter, the output decreases at -6 dB/oct due to the action of the 0.0033 μ F capacitor.

The purpose of the control paths is to generate a bandwidth control signal which replicates the ear's sensitivity to noise in the presence of a tone. A single control path is used for both channels to keep the stereo image from wandering. This is done by adding the right and left channels together in the summing amplifier of Figure 2. The R1, R2 resistor divider adjusts the incoming noise level to open slightly the bandwidth of the low pass filter. Control path gain is about 60 dB and is set by the gain amplifier and peak detector gain. This large gain is needed to ensure the low pass filter bandwidth can be opened by very low noise floors. The capacitors between the summing amplifier output and the peak detector input determine the frequency weighting as shown in the typical performance curves. The 1 μ F capacitor at pin 10, in conjunction with internal resistors, sets the attack and decay times. The voltage is converted into a proportional current which is fed into the gm blocks. The bandwidth sensitivity to gm current is 33 Hz/ μ A. In FM stereo applications at 19 kHz pilot filter is inserted between pin 8 and pin 9 as shown in Figure 1.

Figure 3 is an interesting curve and deserves some discussion. Although the output of the DNR system is a linear function of input signal, the -3 dB bandwidth is not. This is due to the non-linear nature of the control path. The DNR system has a uniform frequency response, but looking at the -3 dB bandwidth on a steady state basis with a single frequency input can be misleading. It must be remembered that a single input frequency can only give a single -3 dB bandwidth and the roll-off from this point must be a smooth -6 dB/oct.

A more accurate evaluation of the frequency response can be seen in Figure 4. In this case the main signal path is frequency swept, while the control path has a constant frequency applied. It can be seen that different control path frequencies each give a distinctive gain roll-off.

Psychoacoustic Basics

The dynamic noise reduction system is a low pass filter that has a variable bandwidth of 1 kHz to 30 kHz, dependent on music spectrum. The DNR system operates on three principles of psychoacoustics.

1. White noise can mask pure tones. The total noise energy required to mask a pure tone must equal the energy of the tone itself. Within certain limits, the wider the band of masking noise about the tone, the lower the noise amplitude need

Circuit Operation (Continued)

be. As long as the total energy of the noise is equal to or greater than the energy of the tone, the tone will be inaudible. This principle may be turned around; when music is present, it is capable of masking noise in the same bandwidth.

2. The ear cannot detect distortion for less than 1 ms. On a transient basis, if distortion occurs in less than 1 ms, the ear acts as an integrator and is unable to detect it. Because of this, signals of sufficient energy to mask noise open bandwidth to 90% of the maximum value in less than 1 ms. Reducing the bandwidth to within 10% of its minimum value is done in about 60 ms: long enough to allow the ambience of the music to pass through, but not so long as to allow the noise floor to become audible.

3. Reducing the audio bandwidth reduces the audibility of noise. Audibility of noise is dependent on noise spectrum, or how the noise energy is distributed with frequency. Depending on the tape and the recorder equalization, tape noise spectrum may be slightly rolled off with frequency on a per octave basis. The ear sensitivity on the other hand greatly increases between 2 kHz and 10 kHz. Noise in this region is extremely audible. The DNR system low pass filters this noise. Low frequency music will not appreciably open the DNR bandwidth, thus 2 kHz to 20 kHz noise is not heard.

Block Diagram

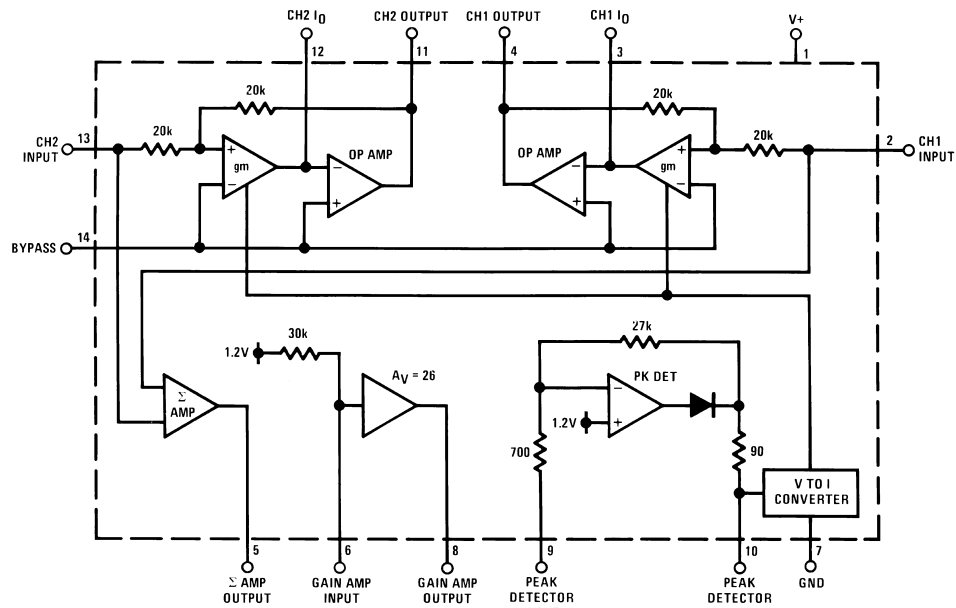

DS007918-7

FIGURE 2.

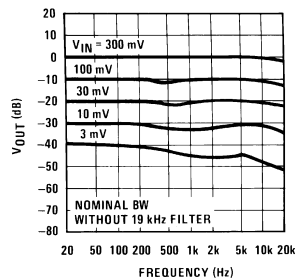

FIGURE 3. Output vs Frequency

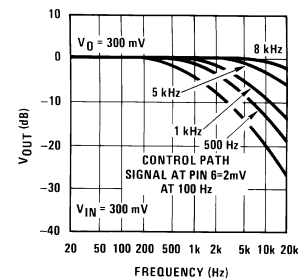

FIGURE 4. -3 dB Bandwidth vs Frequency and Control Signal

Application Hints

The DNR system should always be placed before tone and volume controls as shown in *Figure 1*. This is because any adjustment of these controls would alter the noise floor seen by the DNR control path. The sensitivity resistors R1 and R2 may need to be switched with the input selector, depending on the noise floors of different sources, i.e., tape, FM, phono. To determine the value of R1 and R2 in a tape system for instance; apply tape noise (no program material) and adjust the ratio of R1 and R2 to open slightly the bandwidth of the main signal path. This can easily be done by viewing the capacitor voltage of pin 10 with an oscilloscope, or by using the circuit of *Figure 5*. This circuit gives an LED display of the voltage on the peak detector capacitor. Adjust the values of R1 and R2 (their sum is always 1 k Ω) to light the LEDs of pin 1 and pin 18. The LED bar graph does not indicate signal level, but rather instantaneous bandwidth of the two filters; it

Application Hints (Continued)

FOR FURTHER READING

Tape Noise Levels

1. "A Wide Range Dynamic Noise Reduction System", Blackmer, *dB Magazine*, August-September 1972, Volume 6, #8.
2. "Dolby B-Type Noise Reduction System", Berkowitz and Gundry, *Sert Journal*, May-June 1974, Volume 8.
3. "Cassette vs Elcaset vs Open Reel", Toole, *Audioscene Canada*, April 1978.
4. "CCIR/ARM: A Practical Noise Measurement Method", Dolby, Robinson, Gundry, *JAES*, 1978.

Noise Masking

1. "Masking and Discrimination", Bos and De Boer, *JAES*, Volume 39, #4, 1966.
2. "The Masking of Pure Tones and Speech by White Noise", Hawkins and Stevens, *JAES*, Volume 22, #1, 1950.
3. "Sound System Engineering", Davis Howard W. Sams and Co.
4. "High Quality Sound Reproduction", Moir, Chapman Hall, 1960.
5. "Speech and Hearing in Communication", Fletcher, Van Nostrand, 1953.

Printed Circuit Layout

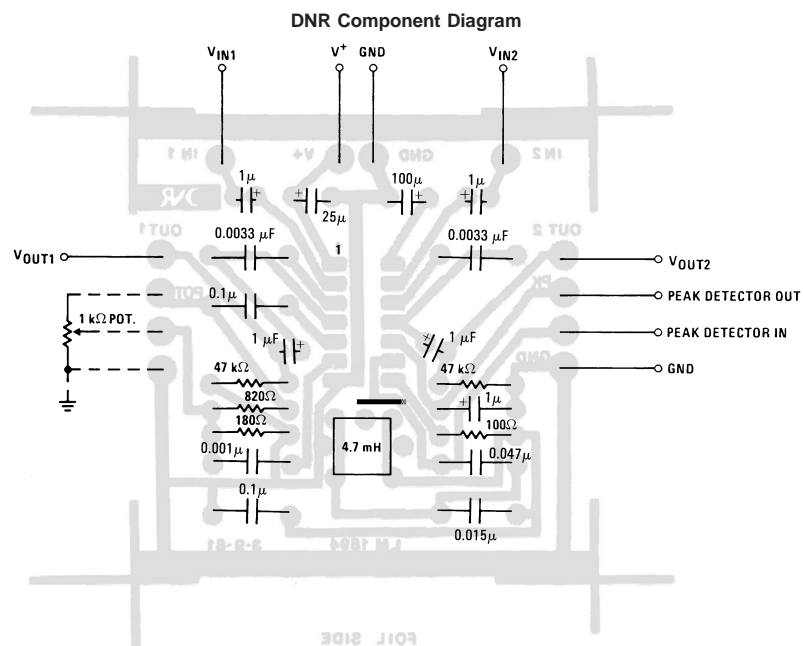

Physical Dimensions inches (millimeters) unless otherwise noted

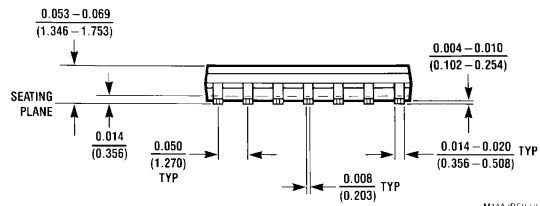
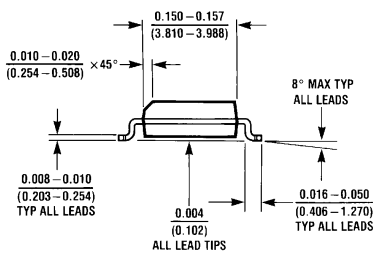
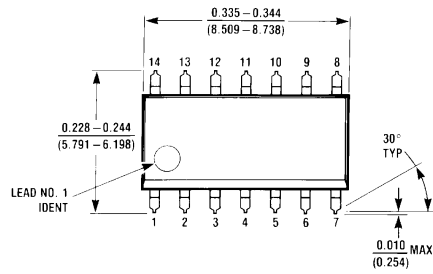

M14A (REV H)

SO Package (M)
Order Number LM1894M
NS Package Number M14A

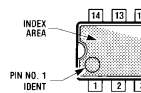
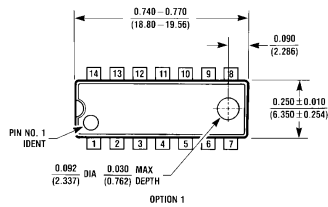

OPTION 1

OPTION 02

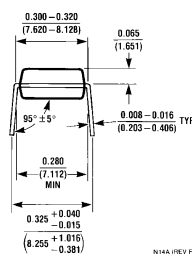
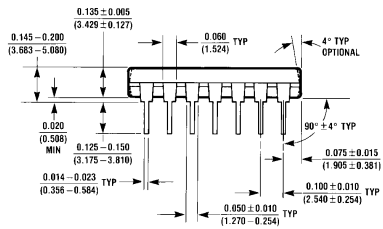

N14A (REV F)

Molded Dual-In-Line Package (N)
Order Number LM1894N
NS Package Number N14A

Notes

LIFE SUPPORT POLICY

NATIONAL'S PRODUCTS ARE NOT AUTHORIZED FOR USE AS CRITICAL COMPONENTS IN LIFE SUPPORT DEVICES OR SYSTEMS WITHOUT THE EXPRESS WRITTEN APPROVAL OF THE PRESIDENT AND GENERAL COUNSEL OF NATIONAL SEMICONDUCTOR CORPORATION. As used herein:

1. Life support devices or systems are devices or systems which, (a) are intended for surgical implant into the body, or (b) support or sustain life, and whose failure to perform when properly used in accordance with instructions for use provided in the labeling, can be reasonably expected to result in a significant injury to the user.
2. A critical component is any component of a life support device or system whose failure to perform can be reasonably expected to cause the failure of the life support device or system, or to affect its safety or effectiveness.



National Semiconductor Corporation
Americas
Tel: 1-800-272-9959
Fax: 1-800-737-7018
Email: support@nsc.com

www.national.com

National Semiconductor Europe

Fax: +49 (0) 1 80-530 85 86
Email: europe.support@nsc.com
Deutsch Tel: +49 (0) 1 80-530 85 85
English Tel: +49 (0) 1 80-532 78 32
Français Tel: +49 (0) 1 80-532 93 58
Italiano Tel: +49 (0) 1 80-534 16 80

National Semiconductor Asia Pacific Customer Response Group

Tel: 65-2544466
Fax: 65-2504466
Email: sea.support@nsc.com

National Semiconductor Japan Ltd.

Tel: 81-3-5639-7560
Fax: 81-3-5639-7507