



Relationships Between Electromagnetic Emission and Signal Integrity at High-Speed

Henri Merkelo, IEEE Fellow,

Director Ultrahigh Speed Digital Electronics
(717) 986.5397 hm@lassi.ece.uiuc.edu

Practical Techniques to Accelerate Product Development Symposium



Abstract

As the new generation of High-speed digital data and communication systems are being designed, the need to review the design rules for signal integrity and electromagnetic emission is renewed. In fact, it is shown that not only should the design rules for signal integrity and for electromagnetic emissions be reviewed separately, but the relationship of one to the other should be reexamined. This presentation focuses on the many signal integrity issues previously discussed and addresses the emissions and susceptibility questions not only in the context of basic radiation laws but with examples based on today's design practices. Specific cases are analyzed, for example, with incorrectly designed connectors and contrasted with connectors developed for high speed by design. Examples are also based on other configurations of impedance discontinuities as

well as on mode conversion phenomena such as parallel-plate waveguide mode, slotline mode and common mode. It is shown that geometric configurations together with dimensional considerations lead to situations that merit attention, ranging from alerting to alarming, and demonstrate the intimate and powerful relationship between signal integrity issues and radiation and susceptibility concerns. This presentation is enhanced with computer-based animated visual aids and should be of interest to all designers of high-speed systems, starting with IC component designers and including digital data and communication system designers.



Author/Speaker
Henri Merkelo, IEEE Fellow

Current Activities:

Henri Merkelo is director of Ultrahigh Speed Digital Electronics, where he is developing methods from predicting digital signal integrity in systems of high complexity. Both geometric complexity and network complexity are at issue. Substantial efforts are being expended toward developing simulation techniques capable of including numerous signal quality, signal degradation and radiation effects in complex logic networks. Attention is particularly focused on both wired and wireless designs, from the point-of-view of both radiation efficiency and radiation suppression. He is involved with the electronics industry in applying these methods to the analysis of advanced and future wired and wireless products.

Author Background:



Dr. Merkelo has made numerous contributions to his field, both with regard to design for high speed and with regard to either optimizing or abating emissions. His principal work has been on the engineering and physics of ultrahigh speed electronic and optoelectronic devices and on the study of propagation of short electronic and optical signals, especially as applied to modern packaging. He has chaired technical sessions on design applications of high-speed technologies, holds patents on ultrahigh speed electronic and optoelectronic devices and has published numerous papers. He has directed numerous short courses and workshops for the industry and has lectured extensively here and abroad. He is an IEEE Fellow and is very active in the IEEE and in the microelectronics industry.



Slide #01

**Relationships Between
Electromagnetic Emission and
Signal Integrity at High Speed**

Henri Merkelo, IEEE Fellow,
Director Ultrahigh Speed Digital Electronics

This paper is enhanced by a number of contributions from very active, enthusiastic, dedicated, and meticulous team members without whose efforts this presentation would have been a small fraction of what it is. When the support staff is taken into account, the list is even longer. Without naming everyone, particular thanks are due to Judi Ebersole and the production staff that prepared the hand-out material indefatigably.

It is clear that, since digital speeds are advancing at unprecedented rates, many advanced products and even high-end consumer products are going to have significant energy content in the GHz range and above. Is it sufficient, then, to simply incorporate into the design rules additional margins as dictated and prescribed by the well known frequency dependence of the fundamental radiation laws in order to maintain emissions at an acceptable level? Or, because of the inadequately controlled impedance environments, some imperfect connector designs, situations that require split ground planes or multiple reference planes crossed by vias, and other situations that lead to the presence of energy in unwanted modes, should additional attention be given to emissions and to system susceptibility? This presentation focuses on the many signal integrity issues mentioned above (and described in previous forums) and answers the emissions and susceptibility questions not only in the context of basic radiation laws but with examples based on today's design practices. Specific cases are analyzed, for example, with incorrectly designed connectors and contrasted with connectors developed for high speed by design. Examples are also based on other configurations of impedance discontinuities as well as on mode conversion phenomena such as parallel-plate waveguide mode, slotline mode and common mode. It is shown that geometric configurations together with dimensional considerations lead to situations that merit attention, ranging from alerting to alarming, and demonstrate the intimate and powerful relationship between signal integrity issues and radiation and susceptibility concerns.

Slide #02

Acknowledgements

- Joe Bolewitz
- Dave Baechtle
- Bill Bernhart
- Tim Hochberg
- Stephane Kugener
- Irene Schoonover
- Tom Dlugolecki
- Jim Schroeder
- Steve Jarrett
- Randy Rhodes
- Dimitry Grabbe
- Mike Strong

As the new generation of high-speed digital data and communication systems are being designed, the natural question that is tempting to ask is whether or not there is a relationship between signal integrity (or lack of it), electromagnetic radiation and system susceptibility to electromagnetic interference. And, if the relationships exists, do they correspond to the increased digital speed in some well behaved, proportionate manner or do they not?

Slide #03

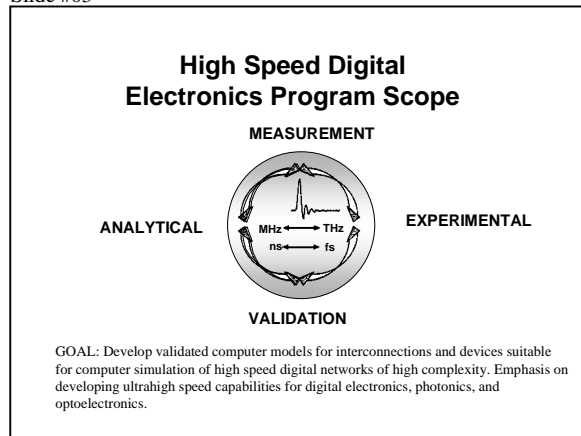

The work in this facility consists of developing tools and methods for understanding and characterizing the impediments to high speed; to find new trade-off solutions to system design; and to test new approaches to noise minimization. In particular, the mission of this group is to develop validated methods for computer simulation of complex structures and systems not characterizable by conventional tools and to provide support to the industry in the development of new products and new high-speed systems. Validation is carried out with both up-to-date commercial instrumentation such as multiple-source Time Domain Reflectometry (TDR), high-speed data generators and broadband network analyzers as well as with special one-of-a-kind picosecond TDR systems, developed specifically for studying unusually fast, unusually broadband phenomena or events that need an unusually high degree of synchronization or timing. Many examples in this presentation consist of computer or communication applications which were developed for or in collaboration with the industry.

Slide #04

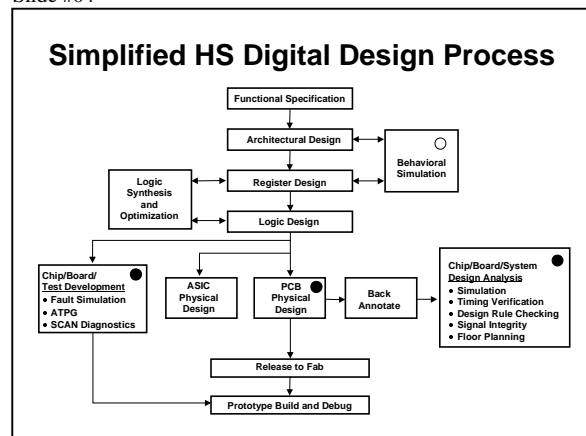

Experience seems to point more and more to the fact that many systems are designed in such a way that it is difficult to provide signal integrity estimation (at a given clock rate) in the early stages of design because the design methods, the tools, and the technologies are not identified sufficiently early. Whereas it is common to have the IC products chosen at the beginning of the design process, the packaging and interconnection methods and products are often not selected in the early stages of the design.

Delaying the decisions on the packaging technologies can result in either an inability to predict system performance or in an inability to meet performance expectations. The latter is frequently the case but either alternative has significant market implications. For these reasons, and for reasons of being able to achieve the full performance potential of a system concept, reviews and assessments of the packaging technologies need to begin in the early stages of the design process. In particular, packaging design team selection and packaging and interconnection technology choices need to be in concert with IC selection, behavioral simulation and plans for system integration.



Slide #05

Outline

- Review of current high speed issues
- Penalties for poor design: example
- Achieving ultrahigh speed by design
- Resonance effects in electromagnetics
- The power of resonance: transmission
- Elements and principles of radiation
- The power of resonance: emissions
- Resources, technologies, conclusions

During the many years that various high-speed phenomena have been studied and digital microelectronic designs evaluated, there has been only several instances that seemed to influence both the technical designs and the business climate as dramatically as the events that are unfolding in front of us today.

Although it is becoming intuitively reasonable that the rapid advances in projected clock rates are going to impact all aspects of designs (both signal integrity and emissions) it is not as convincing as when real numbers emerge, first from the back of an envelope estimates, then from either careful analysis or from measurements.

Having completed several case studies, it is confirmed analytically that a number of situations become particularly dramatic when parameters meet certain criteria by plan or by chance.

As particularly favorable or unfavorable effects manifest themselves, other, sometimes more impacting arguments, can be made.

The results of the case studies are convincing now and, what's more, they could be affecting the business circumstances, in general, and the business of certain enterprises, in particular, to a potentially significant degree.

As suggested in the title, two tasks are at issue: signal integrity and electromagnetic emissions.

Interestingly enough, neither subject is new. We have been talking about signal integrity for many years.

Each time, additional insight has been developed into some particularly complex configurations. Overall, the industry is quite mature even though there are far too few experienced signal analysts for the tasks that lie ahead.

Emission is electromagnetics of a different color. Its management has been largely relegated to containment by gasketing and moating rather than given its own design respectability. It's both embarrassing and sad to see all the books and articles on the black-magic of EMI, etc. Partly for these reasons, our ability to handle emission issues as a design task is going to be much more limited and more difficult in the near future.

If one were to adopt the difficulty in solving these problems in the years to come as a metric, the estimations would go something like this:

- I. Signal integrity problems are going to grow in difficulty by a factor of three very quickly and increase by an order of magnitude over the next decade. Design tools are going to continue to improve and a reasonable industry-wide balance is expected to be maintained. On an individual basis, companies that are unprepared to expand into this direction are risking either failure or loss of market share.
- II. Electromagnetic emissions (and the difficulty of suppressing emissions) are going to ramp up to a ten-fold level very quickly and grow orders of magnitude in the next decade, if not in the next five years.

The premise for emissions is based on several factors:

When the two elemental modes of radiation (the differential mode (DM) and the common mode (CM) are examined and compared, the differential mode radiation has always been dominated by common mode emissions (in the data handling segments of the industry).



The break-even point occurs approximately at 1 GHz when reasonable geometric factors are assumed. Because there are orders of magnitude more of so-called differential mode circuits in the design implementations of data handling products, the differential mode emission easily exceeds the common mode radiation by a factor of ten at 1 GHz.

Because common mode power emission itself grows by an order of magnitude when a 300 MHz design is compared to a 1 GHz design, the overall power emission can grow by a very substantial amount.

The second factor, which is still largely overlooked and unassisted, is much more powerful and much more impacting. As clock frequencies are increasing by dramatic factors, the scale of the geometric components is decreasing only by modest proportions.

In some instances, computer boards are actually increasing in size as the mother/daughter board concept is eliminated. Thus, whereas it is difficult to find characteristic routing dimensions corresponding to one-half wavelength at 300 MHz ($\lambda/2 = 50\text{cm}$ in air, 23 cm in FR4) and lower frequencies, it becomes commonplace when frequencies grow to 500 MHz and above. The propensity for resonance can augment disproportionately. Realizing that electromagnetic emission can easily increase by several orders of magnitudes at resonance, it is clear that one circuit at resonance can exceed the emission of one hundred to a thousand nets that are operating off resonance.

Therefore, the two above conditions, the break-even point for differential mode vs. the common mode emission efficiency at approximately 1 GHz and the increasing probability of finding some nets and ground/power planes at resonance in any one system are going to place an unprecedented burden on designers to deliver products within the emission guidelines. The difficulty is accentuated three fold: the accelerated projected advances in speeds, both on and off chip; the unpreparedness of most engineers to manage emissions in systems of high complexity, and the lack of well developed tools capable of rapid estimation of emissions, especially of unsuspected emissions at resonance.

This condition is a dual-edged sword for our industry. The bad news is that many designers throughout the world are going to be faced with the increasing emission problems, unaware of the more subtle emission issues, especially at and near resonance.

The good news is that this represents enormous opportunities for those who are in advanced design and in emission suppression businesses.

Slide #06

The Seven Campaigns

- Where are the current RETURN paths?
- There are NO parasitics anywhere!
- "Noise", NOT noise! Not-noise is algebraic.
 - Apply noise CANCELLATION to designs.
- Achieve ultrahigh speed BY DESIGN, analysis.
- Power distribution: a HIGH SPEED network.
- Relate emissions TO lack of signal integrity.
 - Assess power of RESONANCE or near-res.
- Achieve low emission/susceptibility, BY DESIGN

This presentation builds on the resources and results developed over the years as the design challenges increased with high speed. Many of these results have been reported and discussed on this very platform which, itself, has grown to be the platform of choice for designers of high performance.

Slide #07

Outline

- *Review of current high speed issues*
- Penalties for poor design: example
- Achieving ultrahigh speed by design
- Resonance effects in electromagnetics
- The power of resonance: transmission
- Elements and principles of radiation
- The power of resonance: emissions
- Resources, technologies, conclusions

Rather than show and perhaps repeat numerous charts of projections for high speed and other roadmaps for the microelectronics industry, let's simply take it as a given that high speed is upon us and, as designers, it is of the utmost importance to assess all the implications starting at the component level and following through to the system level. Examples have been selected to illustrate effects from 1 Gbit/s and above.

Slide #08

Digital Electronics

Transient or Steady State Harmonic?

- $L_e \ll \lambda/4$ for all f to f_{max} : transient only
- $L_e \geq \lambda/4$ for all f to f_{max} : transient + SS
- SS: data and electrical length dependent

It is well known that time varying signals in networks that contain reactive components are described by differential equations that have both natural and forced response solutions. Moreover, these effects combine to produce both transient and steady-state phenomena.

In the design of digital electronics, transient effects must be considered always. At times, more often than we think, steady-state effects are established; sometimes they prevail, and sometimes they dominate the behavior of a design.

In the distribution of clocks, all steady-state harmonic phenomena must be taken into account. For digital signals, such parameters as word length and data patterns (periodicity of data bits), affect the degree to which steady state is established. Of course, because of the data dependence of these effects, the worse case of a design corresponds to the full establishment of the steady-state condition, even if only during finite intervals. In general, it is safe to say that the achievement of steady state is enhanced and accelerated by the lack of controlled impedance design. For this reason, strong interplay exists between steady state and signal integrity, which accentuates a number of effects.

Slide #09

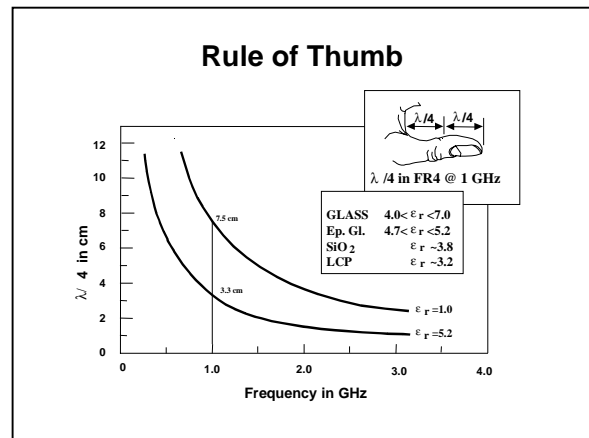

Even though it is not unusual to see references to various electromagnetic effects as occurring on a $\lambda/2$ scale, many very strong effects occur, in fact, on a $\lambda/4$ dimension for all electromagnetic frequencies, whether optical, microwave, or radio. Several of these effects are discussed and demonstrated.

Slide #10

Emissions and Scaling

- Scaling to system?
- Scaling to silicon?
- Scaling to frequency?

As far as emission is concerned, many of the problems that are going to be encountered relate to the fact that we have no scaling rules in building our systems. Even if we tried to scale, we might be hard pressed to agree on a uniform set.

Slide #11

Elemental Radiators

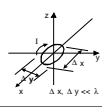

○ Small loop in xy-plane; differential mode: DM

$E_{DM} (\theta = 90^\circ) \approx 1.32 \times 10^{-14} \times \Delta A \times I r \times f^2 \text{ V/m}$

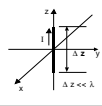

○ Short element along z-axis; common mode: CM

$E_{CM} (\theta = 90^\circ) \approx 1.26 \times 10^{-6} \times \Delta z \times I r \times f \text{ V/m}$

Weeks, W. L., "Electromagnetic Theory for Engineering Applications", Wiley, NY, 1964.

Our discussion is best started with a look at some results that come from fundamental considerations. There are a number of dependencies that have very important implications, which are reviewed later in the discussion. For now, let's focus on the significance of ΔA and Δz .

Slide #12

Scaling to Frequency

If we were scaling systems and silicon to frequency (wavelength):

ex: $\Delta x, \Delta y, \Delta z = \lambda/10,$

emissions would remain constant:

$E_{cm} \approx 3E_{dm}$

Reduction of common mode BY DESIGN

Because the relationships for the radiated electric fields apply when $\Delta x, \Delta y, \Delta z$ are much smaller than wavelength λ , a very interesting conclusion is reached when the geometry is expressed in terms of wavelength. For example, if $\Delta x, \Delta y, \Delta z = \lambda/10$, the radiated fields are frequency independent and the common mode radiated field is only approximately three times larger than the differential mode field. This could be referred to as scaling to wavelength or frequency (actually to the inverse of frequency). The frequency could be either the fundamental or a harmonic as selected by the designer. Such scaling would not introduce any new difficulties with emissions regardless of the operating rate of the system and this would be the end of this presentation.

Slide #13

Not Scaling to Frequency

The penalty for not scaling to frequency (λ) leads to a plethora of effects, some of which are extremely powerful: orders of magnitude multipliers.

Most of the time, both components (boards, packages, heat sinks, etc.) and signal nets shrink at an uneven pace and certainly not evenly in inverse proportion to data rate advances.

Slide #14

Outline

- Review of current high speed issues
 - Penalties for poor design: example
- Achieving ultrahigh speed by design
- Resonance effects in electromagnetics
- The power of resonance: transmission
- Elements and principles of radiation
- The power of resonance: emissions
- Resources, technologies, conclusions

The following example illustrates the degree to which both signal quality and emissions can be compromised when certain conditions exist either by design or by chance. It is shown later that under different circumstances the conditions can be considered fortuitous or even serendipitous.

The example consists of examining the coupling of energy from a microstrip signal-mode to a so-called slotline mode and back to a signal mode to a neighboring microstrip. The geometry is shown below.

Slide #15

Examples of Split Ground and Power Planes

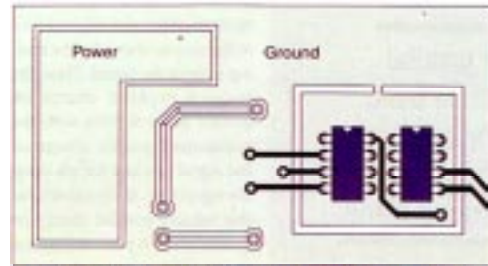

From a signal integrity point-of-view, slots in power or ground planes are discontinuities in the current return paths and, therefore, should be avoided. However, in practical layouts, there are many cases in which slots in ground or power planes are necessary.

Many systems require multiple power supplies, while many PCBs may have only two layers of metal for power distribution. In order to distribute multiple voltages with low inductance, the easiest way is to cut the ground and power planes into several sections. The left side of the figure illustrates such a case.

To the left of the center, another example of ground splitting is shown. Two signal segments are shown to be routed in the ground plane. It is generally considered not a good idea to use part of the ground or power plane for signal routing. When signal integrity considerations are well understood and the accompanying effects are determined to be acceptable, cutting away part of the ground or power plane can provide additional space for critical routing.

The last example is illustrated on the right hand side of the figure. This example represents an isolated power or ground area, usually referred to as an island. Such islands can be used to isolate a noisy or sensitive circuit from others. They are particularly useful for mixed-signal designs in which the noise generated by the digital circuits must be isolated from the sensitive analog circuits.

Slide #16

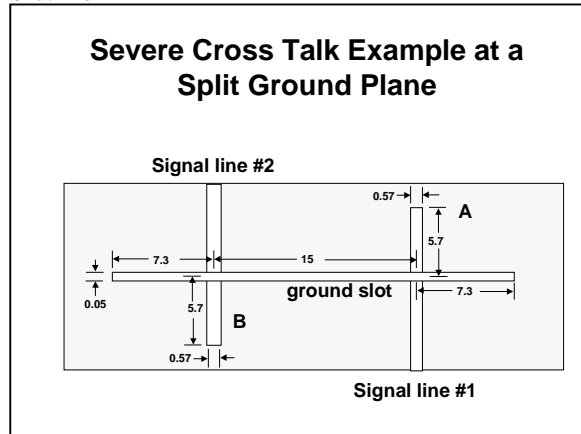

This particular geometry of a partially split ground plane could represent two power planes at two different dc-potentials. The shorts at the two ends could be ac-shorts made with decoupling capacitors and the slot is crossed by high-speed signals guided by microstrip lines. This example is chosen for purposes of model validation since experimental results are available for comparison. It also serves as an illustration of conditions that could approximate a board design (as it, in fact, has) but perhaps with somewhat different geometric parameters.

Other than at the launch site where planar fields are launched, no TEM or irrotational approximations are made anywhere in the propagation. The launch site is generally chosen to be some convenient section of the structure, preferably where controlled impedance prevails, such that a plane wave launch corresponds to a good initial guess of the fields in that space. The whole geometry is described by its metallic and dielectric boundaries. When appropriate and computationally advantageous, walls of symmetry such as perfect electric and perfect magnetic walls and walls that absorb all energy, generating no reflections, are incorporated.

After the signal is allowed to propagate through the entire component, all fields are saved for all time steps and are available for viewing and analysis. Because all aspects of electric fields, magnetic fields, and surface currents can be inspected at any point in space with any desired resolution in space or time, one can think of this approach as having a perfectly instrumented laboratory in which all aspects of characterization can be measured with any desired resolution or precision, anywhere within the space of the object. It is already obvious from this qualitative illustration that a substantial amount of energy is transferred from one signal line to the other through considerable distance. The quantitative results are shown in the following illustrations.

Slide #17

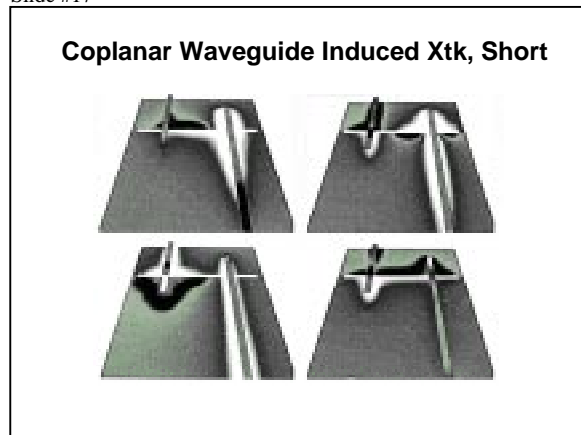

In order to be able to analyze and visualize some of the more complex situations, the results of a full-wave, 3D solver are rendered into graphics for visualization as well as for characterization. The algorithm for the simulation of propagation is electromagnetically exact, without any wave propagation approximations.

Slide #18

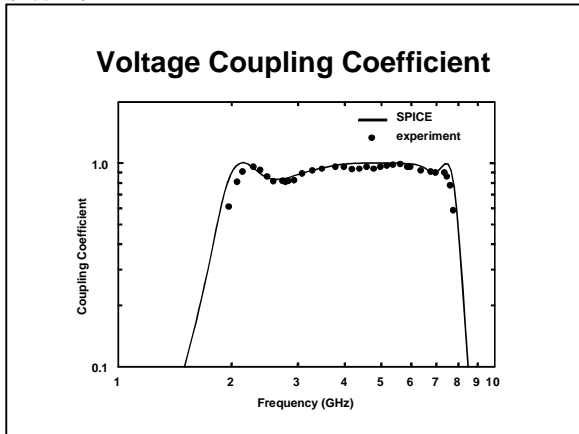

Considering that the signal line (#1) is separated from the quiet line (#2) by a distance more than ten fold greater than conventional board design rules require, it would be surprising to see even a small fraction of a percent of signal energy appear on the quiet line in the absence of the reference plane slot. To see 96% of the signal transferred to the quiet line across such a large distance and over such a broad frequency range could be, of course, catastrophic in a digital design. It should not be surprising that a number of situations have approximated these conditions within our industry, albeit for different dimensions and different data rates.

Slide #19

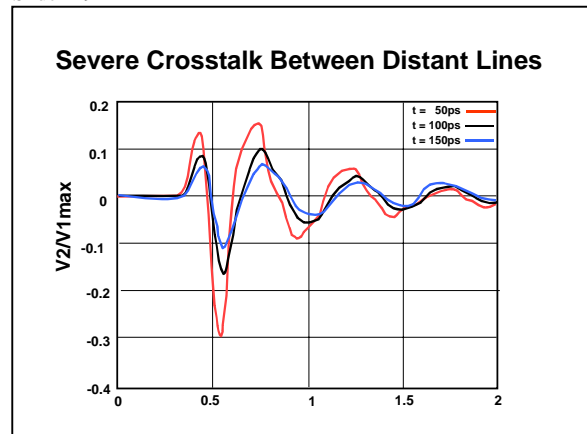

The effectiveness of peak energy transfer between these remote signal lines by the slotline mode conversion process is diminished by the dephasing property of the structure. Nevertheless, very significant fractions of a signal level are transferred onto a quiet line when risetimes are short, even when only one signal line exists on the board. Full signal level on the quiet line can be achieved when a wide bus involves simultaneous switching of several lines. (Some of these results, together with validated SPICE models, have been published in the IEEE Circuits and Devices and are available by request by e-mail.)

The severity of signal quality degradation in this example brings up many of the issues that have been discussed at this forum which, as illustrated, are accentuated by the special conditions of resonance: terminations, controlled impedance, mode conversion, cross talk, ground bounce, data dependence, noise cancellation, and what is an increased focus today, radiation and susceptibility to radiation.

Slide #20

Outline

- Review of current high speed issues
- Penalties for poor design: example
 - *Achieving ultrahigh speed by design*
- Resonance effects in electromagnetics
- The power of resonance: transmission
- Elements and principles of radiation
- The power of resonance: emissions
- Resources, technologies, conclusions

Slide #21

Principles of Noise Cancellation by Reactive Compensation and Localization

Compensation:
 Since electromagnetic reflections are caused by discontinuities in impedances and impedances are measures of the ratio between inductance and capacitance, it is suggested that restoring the ratio between the total inductance and total capacitance in a given region can restore the matching and eliminate reflections if conditions for relative localization can be satisfied.

Localization:
 Relative localization can be achieved (even when the mismatched and the compensating regions are not coincident in space) when the total propagation time through the mismatched and the compensating regions is much shorter than signal risetime.

The severity of the previous example shows that, under certain conditions, order(s) of magnitude effects can appear unexpectedly in our designs when certain conditions are met. What's worse, even when the conditions are only approximated, the effects can still be much larger than anticipated and, because these are manifestations of steady-state conditions, they are extremely data dependent and, as is discussed later, also severely affect emissions and susceptibility to emissions.

It is the theme of this paper that many signal degradation effects can be avoided by good design practices. It is also shown later that departures from designs based on a budget of impedance and on noise cancellation principles, discussed in earlier years at this forum, not only affect signal quality but emissions as well. By reciprocity principles, effective emitters of radiation also have a high sensitivity to invasive and interfering radiation and, therefore, a high susceptibility to emissions.

These good design practices can only be achieved with attention to detail and, therefore, applied at component level. They must be followed through all the way to system level with strict design principles and choice interconnection products, also designed specifically for the required speeds, without compromise.

Consider a few examples of the attention to detail in the application of noise cancellation methods to the design of interconnections for high speed.

Slide #22

Compensation

Discrete discontinuities

$$\frac{\sum_{i=1}^N (x_{i+1} - x_i) L_i}{\sum_{i=1}^N (x_{i+1} - x_i) C_i} = Z_0^2$$

Continuous discontinuities

$$\frac{\int_{x_1}^{x_2} L(x) dx}{\int_{x_1}^{x_2} C(x) dx} = Z_0^2$$

The requirement for compensation can be stated for either distributed or discrete discontinuities and even discrete components.

Slide #23

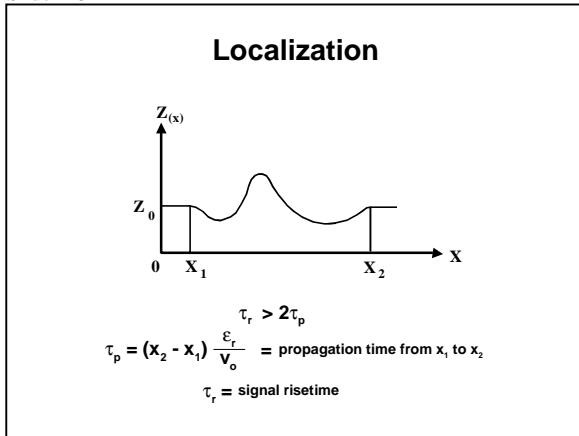

When the condition for compensation is satisfied, noise cancellation is nearly complete when the signal risetime τ_r is greater than twice the propagation time τ_p through the discontinuity. It is important to note that noise cancellation continues to take place even when the localization condition is not satisfied entirely. However, the effectiveness of cancellation diminishes when $2\tau_p$ approaches or exceeds the value of τ_r .

Slide #24

Example of Localization Design Rules for Partial Noise Cancellation ($\epsilon_r = 4.0$)

Risetime, τ_r	Physical length in mm for ~ 90% cancellation	Physical length in mm for ~ 50% cancellation
1 ns	70	140
700 ps	50	100
500 ps	35	70
300 ps	20	40
100 ps	7	14
50 ps	3.5	7

Ideally, compensation should be done exactly at the location of the discontinuity. Then, when reactive compensation is complete, noise cancellation is complete. That is, wherever there is excess inductance, either the excess inductance should be removed or a corresponding amount of excess capacitance should be introduced. That's generally the easiest way to provide compensation when these principles are applied at a sufficiently early stage of design.

The additional motivation is that, in any given geometry, inductance and capacitance have reciprocal relationships. Generally, by providing additional capacitance, inductance in that region is automatically reduced and conversely.

Of course, such absolute localization is seldom possible, especially with geometrically complex components. Then compensation should be provided within the shortest distance possible to the mismatched region. For reflective noise, the amount of residual reflected energy is proportional to $2\tau_p/\tau_r$ where τ_p is the total signal propagation time through both the existing discontinuity and the compensation region and τ_r is signal risetime. Examples of physical lengths are given for $\epsilon_r = 4.00$ for ~90% and ~50% noise suppression.

Slide #25

- Some Features of Reactive Matching**
- Reactive matching applies to both discrete as well as distributed regions.
 - Correlation effects provide additional favorable conditions for system level statistics.
 - Unlike in situations where resistive matching must be used, reactive compensation is without signal penalty other than in possibly modifying propagation delay.

Because reactive components can return to the system all the energy they store, cancellation of noise by reactive compensation is, in principle, without penalty. But, because there are many ways of increasing the inductance to capacitance ratio, the effective propagation distance may change and, therefore, the effective propagation delay may be affected without an actual change in permittivity or permeability.

Slide #26

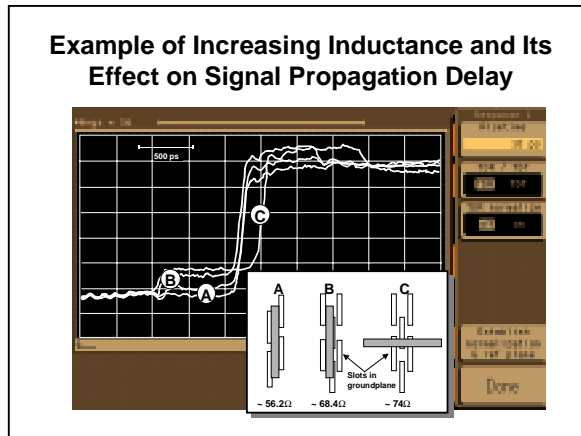

As discussed before, reactive compensation techniques are without penalty except for possibly modifying propagation delay. This example serves to illustrate an untypical method for increasing the inductance-to-capacitance ratio of a microstrip or stripline without either changing the width of the strip or the strip to ground spacing. The connection is made on top of a ground plane perforated with elongated slots which create an anisotropic structure. In this case, the slots also serve as housings for the microinterposer devices described earlier.

Arrangements A, B, and C create progressively higher impedances as a result of modified ground currents and, for the same reason, produce different propagation delays. As seen on the TDR trace, structure B gives the shortest propagation delay and structure C gives a delay 45% longer than that of structure B. These are quite substantial effects, both on impedance and on propagation.

Slide #27

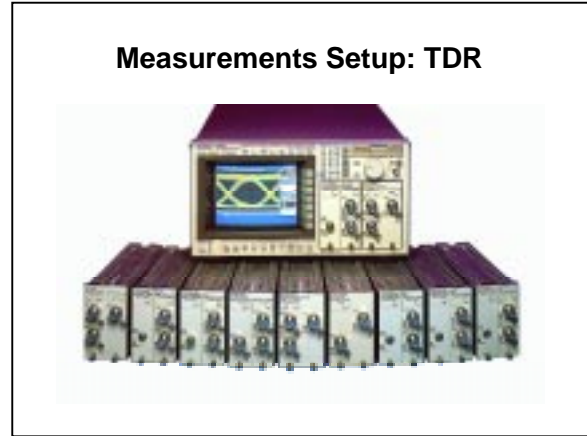

This TDR measurement system consist of a HP 54750A digitizing oscilloscope mainframe. This mainframe accepts the plug-in modules, HP 54753A singled-ended TDR and the HP 54754A differential TDR.

A host of optical plug-in modules, which provide cross-domain capabilities, are also available for this mainframe.

Slide #28

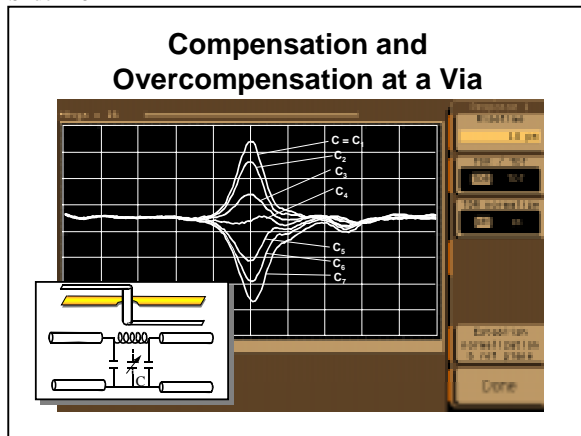

Compensation is very easily demonstrated on a prototype via in which the via region is left open so that additional grounding can be introduced, mimicking an increased capacitance such as that produced by decreasing the via hole size. Because the via geometry is relatively small, localization is satisfied even for $\tau_r = 40$ ps of the TDR system. The illustration shows the reduction and near cancellation of the positive reflected signal as capacitance is introduced into the region. As more capacitance is introduced, the via becomes a low impedance structure and gives a negative reflection.

Thus, changing the risetime by more than a factor of ten spreads the reflection in time but reduces the peak magnitude only by a factor of less than two.

Slide #30

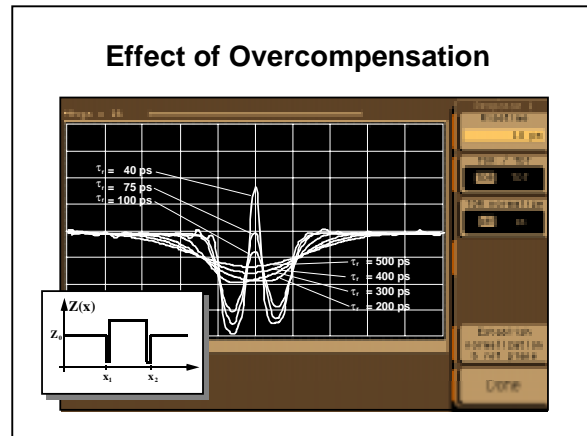

Similarly, when short sections of very low impedance are added at the ends, creating overcompensation, the reflection persists even for $\tau_r = 0.5$ ns.

Slide #29

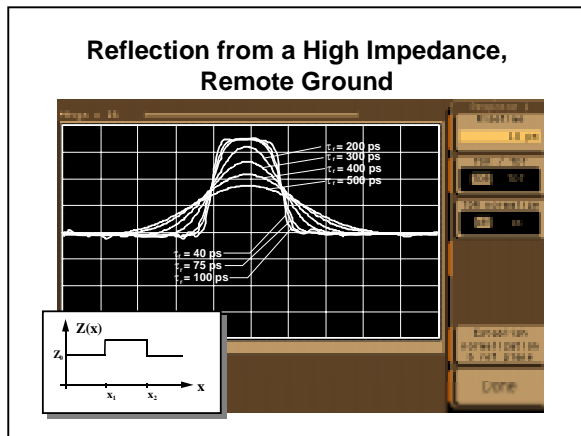

When a discontinuity is of high impedance, such as this remote ground connection of the flex circuit, the magnitudes of reflections from it do not change rapidly as the risetime of the signal is changed, as shown on the traces of an HP TDR system.

Slide #31

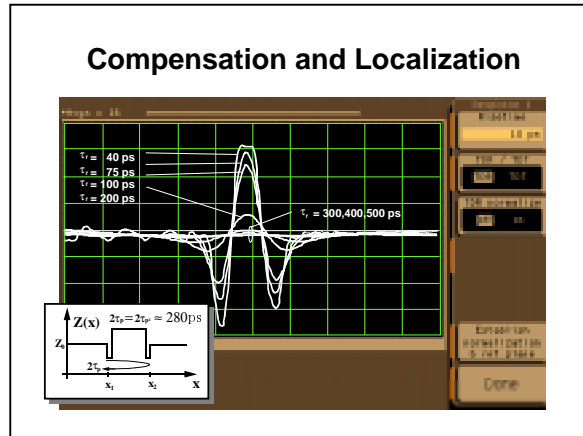

When compensation is of an appropriate amount, high-speed signals still resolve the low-impedance compensation and the high-impedance remote ground. However, when the localization criterion is beginning to be satisfied so that the risetime τ_r starts exceeding $2\tau_p$, the reflection signal is reduced dramatically. Here, the overall length is approximately 3 cm in $\epsilon_r \approx 2.1$, which gives $2\tau_p \approx 280$ ps. Note that when τ_r is longer than ~ 300 ps, the reflection becomes very small and nearly vanishes when $\tau_r = 500$ ps.

Slide #32

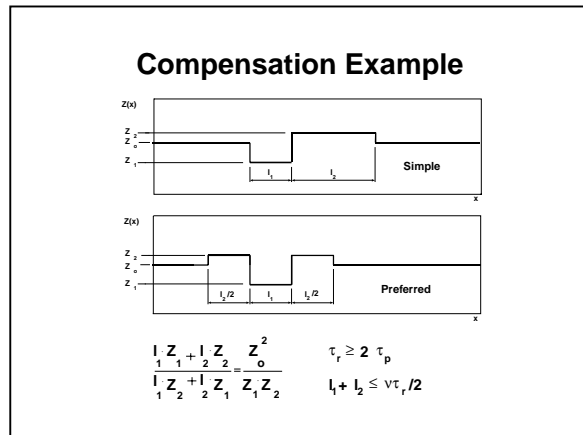

The principles of noise cancellation, which were described and documented with a TDR demonstration in the 1993 High-Speed Digital Symposium digest, published by Hewlett-Packard, are applied to and summarized for the case illustrated above.

From these relations, a family of curves in the next slide illustrates the interdependence of the design variables Z_0, Z_1, Z_2, l_1 and l_2 , where Z_0 is the nominal characteristic impedance within which the system is being designed, Z_1 is a region of low impedance that needs to be compensated by Z_2 and l_1 and l_2 are the respective lengths of Z_1 and Z_2 . The lengths l_1 and l_2 are further restricted by the desired risetime τ_r criterion.

Slide #33

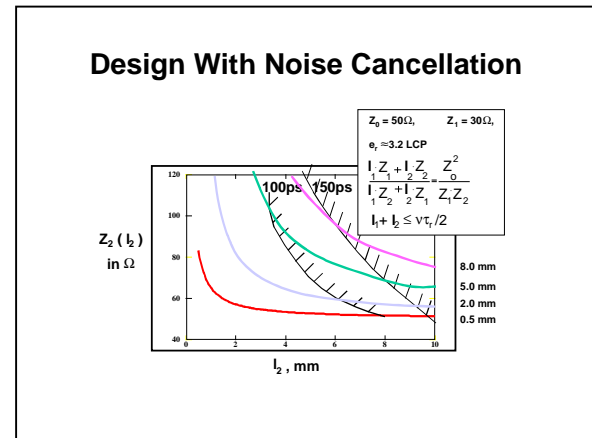

A superposition of the localization criterion over the curves derived for compensation provides the bounds within which l_2 and Z_2 can be chosen. When, for example, the prevailing risetime is 150 ps, a substantial region delineated by the plot is available for selecting l_2 and the corresponding Z_2 . When the risetime is decreased to 100 ps, the region within which l_2 and Z_2 can be chosen is correspondingly decreased.

Slide #34

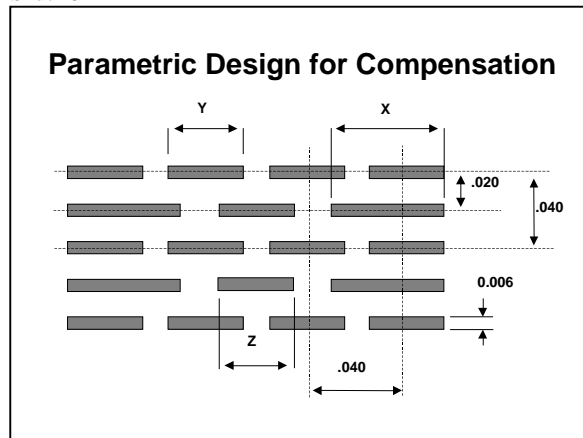

In practice, the design of an interconnecting structure is started with a concept within which the degrees of freedom in the design are parametrized for design optimization. In the above examples, all signal lines are of a dimension Y and reference lines are of dimensions X and Z, all of which are determined and optimized on the basis of controlled impedance and impedance compensation. As before, the localization criterion restricts the dimensional bounds within which the impedance budget must be met. Many methods for compensation exist in addition to the one illustrated above, but the pressure for miniaturization and the need for high density further restrict the choices for design implementation. Nevertheless, unagumative designs combined with the application of good design rules can avoid many pit falls that lead to either poor performance or to excessive emissions.

Slide #35

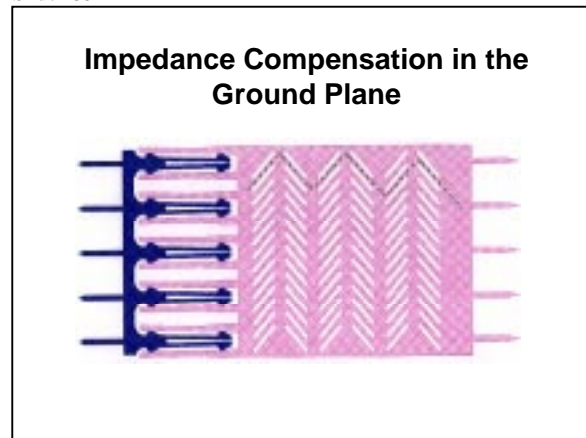

Typically, in the design of very small connectors, one is frequently faced (more often than not) with impedance that's too low. This is surprising to many because in the old fashioned way of specifying inductance and requiring the lowest inductance possible, this sounds contradictory, but true. The main exception to this situation is, of course, the delivery of power because that's done in a very low impedance environment. Since characteristic impedance can be changed in either the signal path or the reference return path, the designer has more inventiveness at the disposal than just concentrating on the signal line. The above example illustrates one of the many ways of achieving an increased impedance if needed for compensation.

Slide #36

Attention to Detail for Compensation

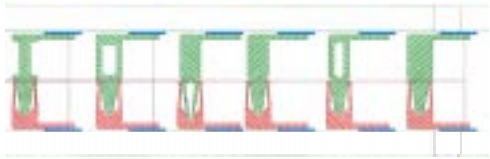

A latitude of possible mechanical designs are explored for improved electromagnetic propagation and noise cancellation

Again, the achievement of high-signal quality at high speed is in the details of the designs. Here intricate patterns can be created within the functional boards of the structures to allow parameterization for the achievement of high speed BY DESIGN!

Slide #37

Streamlining for High Speed

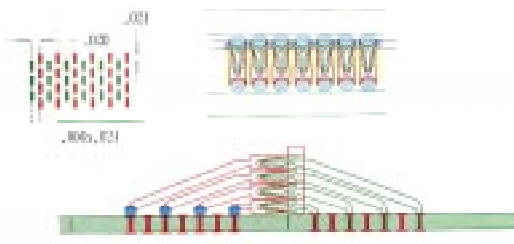

The combined results of implementing the design criteria in an imaginative way can indeed produce high performance within the high-density environment even though not all dimensions available for design necessarily scale conveniently. Here, when ultrahigh speed is considered, even the method of attachment and the near vicinity of routing should be taken into account so that the lame excuse of parasitics is not involved when a system design does not meet expectations.

For that reason, the left side of the connector is shown attached with solder balls and the right hand side is shown attached more conventionally with through vias, indicating that the choice is available. However, in order to achieve, for example, 75 ps risetime without excessive reflections, both the method of attachment and the near vicinity routing should be considered in the final design characterization.

Slide #38

Application to Component Design



An interconnecting structure can be entirely characterized by obtaining the transmitted and reflected waveforms to impulse inputs. Impulse inputs $\delta_i(t)$ and $\delta_r(t)$ are numerically generated at both ends of the structure and the transmitted responses h_{ti} and h_{ro} and the reflected responses h_{ri} and h_{ro} are determined. This method of characterization defines the reflective and transmitting signal response properties of a component and provides an analytical description suitable for the simulation of a network of components.

Thus, for numerical evaluation of the performance of different packaging technologies and methods, both an electromagnetic component characterization tool and a network simulation tool are required.

In order to be able to analyze and characterize geometrically complex structures, a full-wave, transient, 3D solver is used to propagate an impulse electromagnetic wave through the component as designed.

Slide #39

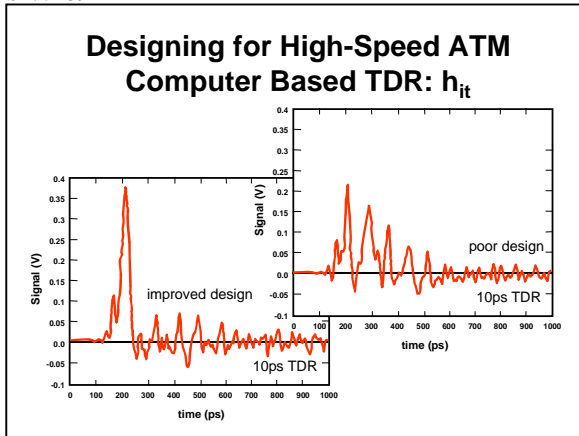

Example of simulated transmission transfer functions h_{it} for a relatively poor design and a much improved design.

Slide #41

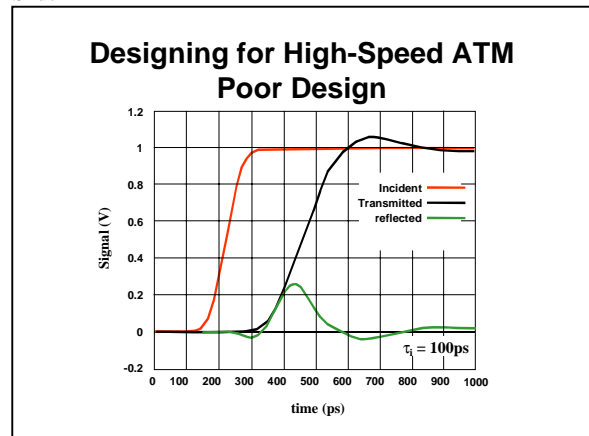

Transmitted and reflected signals obtained by the convolution of a 100 ps risetime signal with h_{it} and h_{ir} , respectively, for a relatively poor design.

Slide #40

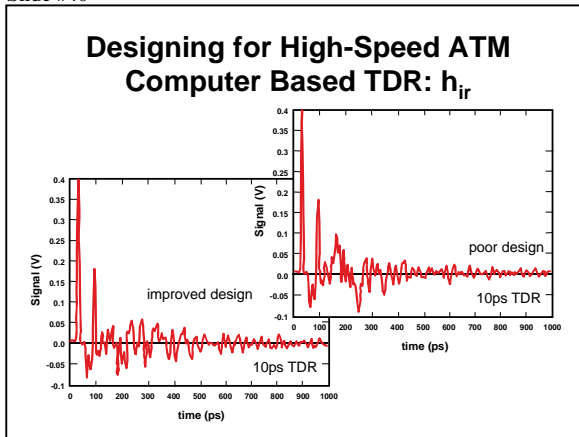

Examples of simulated reflection transfer functions h_{ir} for a relatively poor design and a much improved design.

Slide #42

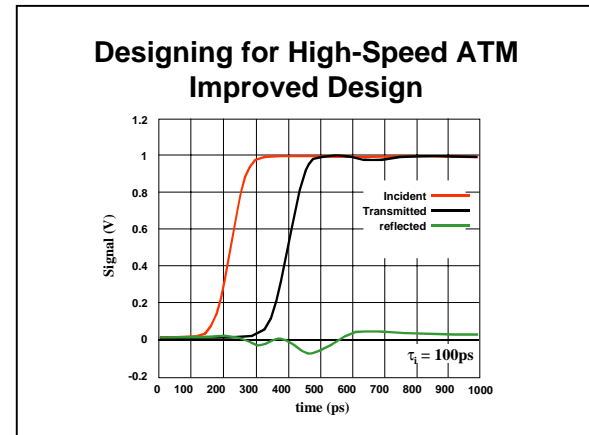

Transmitted and reflected signals obtained by the convolution of a 100 ps risetime signal with h_{it} and h_{ir} , respectively, for a much improved design.

Slide #43

Miniature Separable Contacts

In many situations, assembly is facilitated when chips can be mounted in a separable way.

Slide #45

Quad Contacts for Array Applications

1488 separable contacts: SGSG
20 x 25 mil pitch

Similarly, the quad contact design that was used for illustrating parametric design can be set in a connector housing or incorporated into mating separable arrays as shown above.

Slide #44

Shorting V Contact in Land Grid Applications

$Z_o = 46 \Omega (0.32 \text{ nH}) @ 1.25 \text{ mm}; 65 \text{ gmf/contact.}$

Even at the level of contact pairs, it is possible to continue maintaining an impedance notion so that the designer can maintain a reasonable impedance budget and effect suitable compensation criteria. The shorting V design shown above allows the reduction of inductance to a fraction of what it would be for a straight wire and, therefore, maintain a characteristic impedance between 40 and 50 Ω , depending on the material of the housing and whether the design is for 1 or 1.25 mm pitch. The LCP housing section shown on the right is designed for tiling applications so that structures of hundreds and thousands of contacts could be laid out.

Slide #46

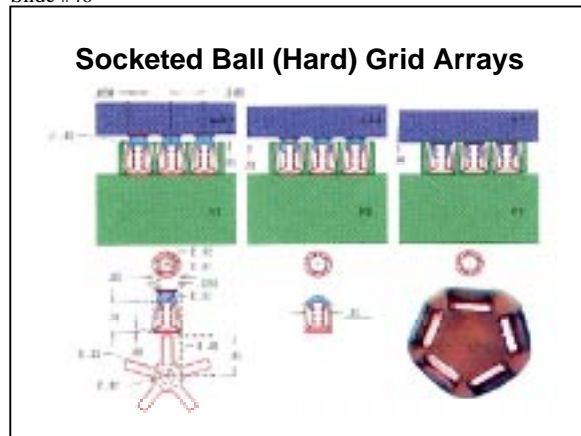

With a hard ball approach, a socketing structure is illustrated in a tulip-like shape, also for separable applications.

Slide #47

Outline

- Review of current high speed issues
- Penalties for poor design: example
- Achieving ultrahigh speed by design
 - Resonance effects in electromagnetics
- The power of resonance: transmission
- Elements and principles of radiation
- The power of resonance: emissions
- Resources, technologies, conclusions

The reasons for reviewing good signal integrity practices in the context of emissions are numerous. But, if there were only one, it would be because of the possibility of establishing electromagnetic resonance or near resonance. And, of course, the reason for trying to assess the effects of resonance on signal quality and particularly on emissions is that it is well known that resonance effects are orders-of-magnitude effects, not just fractional or multipliers; that is, even a weak resonance can be a strong or even catastrophic effect.

Slide #48

Revisiting the Fabry-Perot Resonator

$T_I = 0$ When R is High

$T_I \approx 1$ When $L = n \lambda/2$

Fabry et Perot, *Annales de Chimie et de Physique* (7), 16 (1899) 115 and earlier Airy, *Philosophical Magazine*, 2 (1833) 20.

One of the best (and the oldest) demonstrations of resonance and its powerful effect comes from works in optics and spectroscopy. One way to begin to appreciate the effectiveness of resonance is to contrast the transmission characteristics of one mirror with those of two mirrors at resonance. When the reflectivity of the mirrors R is very high, the comparison of transmission characteristics of one mirror to the transmission characteristics of two mirrors at resonance consists of dividing nearly 100% by nearly zero. Regardless of how close one is to zero and to 100%, respectively, the ratio is enormous and provides the warning needed to appreciate systems at resonance.

Slide #49

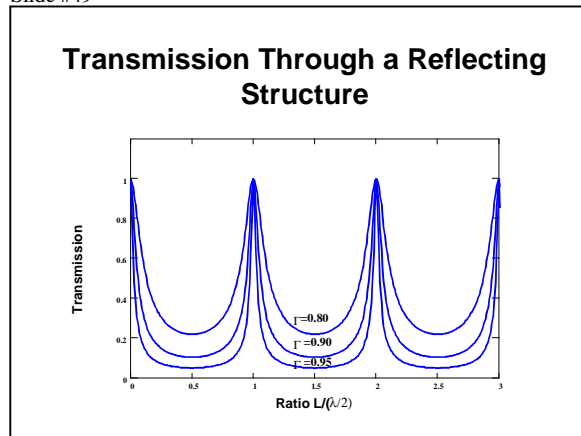

The interesting observation about the optical resonator is that the transmission coefficient at resonance is not a function of the mirror reflectivity R_0 . The transmission at resonance is always 100% for lossless mirrors! The reflectivity only affects the bandwidth of the resonance and, therefore, the amount of transmitted energy off-resonance. The above curves are somewhat universal and apply to resonance phenomena in optics, transmission lines, microwaves and many other phenomena within electromagnetics and even mechanics. The analogies between this example and the structures that we want to study exist in many different forms, some more easily recognizable than others.

Slide #50

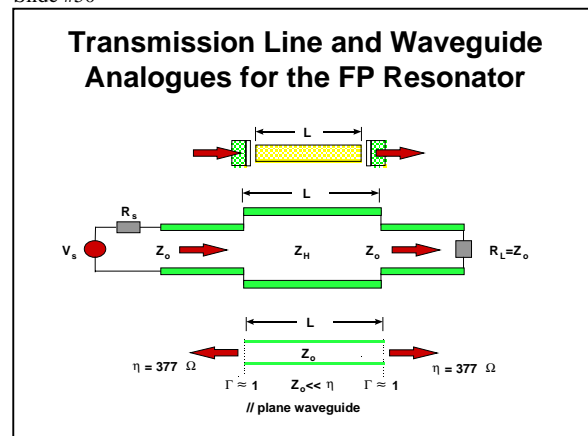

The two structures that are obvious analogues for the Fabry Perot (FP) resonator are:

1. A transmission line discontinuity of characteristic impedance Z_H and length L sandwiched between transmission lines of characteristic impedance Z_0 . One is terminated in $R_L = Z_0$ and the other contains the source resistance $R_S = R_L = Z_0$. The relationship for the power delivered to the load is exactly analogous to the expression for the power transmitted through the FP resonator, reaching 100% at resonance when $L = \lambda/2$.
2. A parallel plane waveguide resonator with open ends. Because of the very low impedance Z_0 of the parallel plane waveguide when the planes are close together, such as is the case with circuit boards, the reflection coefficient Γ at the interfaces is very high. In this sense, it resembles the FP resonator when the energy is in the fundamental mode. The implication, of course, is that when the parallel plane waveguide mode is launched between the planes and the resonance conditions are satisfied, this energy is emitted into space very efficiently in spite of the very high Γ at the interfaces. Again, at resonance, Γ is not a parameter in the emission at resonance; Γ determines how sharp this resonance is and how much energy is emitted when the structure is electromagnetically off-resonance.

These comparisons can enhance intuitive estimations and can help guard a designer from committing more serious errors in judgment. Many other analogies exist which undergo the enhancements of resonance. Even though it is not within the scope of this presentation to review all the possibilities, a few other structures are examined, some carefully and others by deduction.

Slide #51

Outline

- Review of current high speed issues
- Penalties for poor design: example
- Achieving ultrahigh speed by design
- Resonance effects in electromagnetics
 - *The power of resonance: transmission*
- Elements and principles of radiation
- The power of resonance: emissions
- Resources, technologies, conclusions

Slide #52

Effect of Resonance on Signal Quality and Emissions: One Circuit

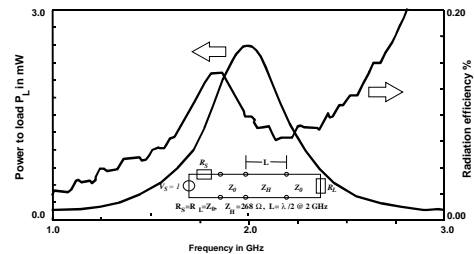

This is the circuit that was compared to the Fabry-Perot resonator. Now we examine it carefully and analytically for the entire power balance. Note that the power delivered to the load P_L follows the same pattern as the transmission curves for the FP resonator. When radiation is neglected, P_L reaches its maximum where expected, and the value is simply the power corresponding to the source loaded by R_s in series with R_L without any transmission line effects. That is a 100% power transfer after the dissipation in R_s is taken into account, just like a transmission system at resonance should do.

When radiation is taken into account, not much is changed simply because the radiation impedance is high and, therefore, the currents circulating on the circuit are substantially the currents corresponding to the circuit parameters, shunted very weakly by the radiation impedance.

The radiated power has two dependencies: 1) the overall frequency dependence which, for a differential mode circuit, should be growing as the fourth power of frequency and 2) the variation in emission which is more or less proportional to the overall energy on the circuit. The currents are largely dependent on the circuit parameters as seen by the source. As the circuit goes in and out of resonance, this dependence becomes very strong and masks somewhat, the rate of growth of radiated power as the frequency is increased.

Slide #53

Outline

- Review of current high speed issues
- Penalties for poor design: example
- Achieving ultrahigh speed by design
- Resonance effects in electromagnetics
- The power of resonance: transmission
- *Elements and principles of radiation*
- The power of resonance: emissions
- Resources, technologies, conclusions

Slide #55

Elemental Radiators

○ Small loop in xy-plane; differential mode: DM

$$E_{DM}(\theta = 90^\circ) \cong 1.32 \times 10^{-14} \times \Delta A \times I/r \times f^2 \text{ V/m}$$

○ Short element along z-axis; common mode: CM

$$E_{CM}(\theta = 90^\circ) \cong 1.26 \times 10^{-6} \times \Delta z \times I/r \times f \text{ V/m}$$

Weeks, W. L., "Electromagnetic Theory for Engineering Applications", Wiley, NY, 1964.

Slide #54

Radiation

$$\mathbf{A}(\mathbf{r}, t) = \frac{\mu}{4\pi} \int \frac{\mathbf{J}(\mathbf{r}', t - R/v)}{R} dV'$$

$$V(\mathbf{r}, t) = \frac{1}{4\pi\epsilon} \int \frac{\rho(\mathbf{r}', t - R/v)}{R} dV'$$

$$\nabla \times \mathbf{H} = \epsilon \dot{\mathbf{E}} + \mathbf{J}$$

$$\mu \mathbf{H} = \nabla \times \mathbf{A}$$

By applying elementary principles of radiation and making the usual geometric assumptions that the characteristic dimensions of the circuit are small compared to the wavelength λ , of interest, the above expressions, as described by Weeks, are obtained.

The argument is made that radiation from microelectronic structures can be categorized into differential-mode and common-mode emitters.

The differential-mode radiation is the result of currents flowing either in loops formed by the conductors of the circuit or by the signal current and the return current of or transmission line, especially as a differential mode. For a small area, $\Delta A = \Delta x \Delta y$, spanned by the circuit, the magnitude of the radiating electric field measured in free space at a distance r in the far field is given by the above expression for E_{DM} in V/m when $\Delta x \Delta y \ll \lambda$. In the magnitude of the current in the loop and, of course, the frequency f , the wavelength λ are related by the velocity of electromagnetic propagation v : $f = v/\lambda$. The assumption $\Delta x, \Delta y \ll \lambda$ simplifies the computations in that the phase of the signal does not need to be considered within the circuits. With that assumption, the expression is accurate for small loops. For the differential mode, the emission is maximum in the plane of the loop (in the xy-plane) and the polarization is parallel to the wire. The expression is derived for a circular loop but as long as the condition $\Delta x \Delta y \ll \lambda$ is satisfied and the result is not very sensitive to the shape of the loop. Analogous observations can be made for the common mode emission.

Slide #56

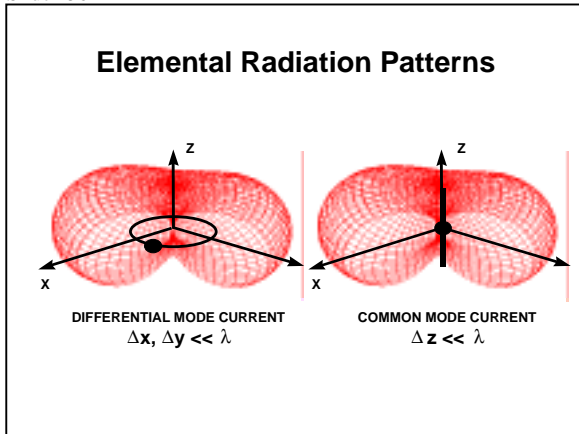

The radiation patterns for the elemental radiators are very similar and differ only in the direction of polarization of the two incremental antennas. When the principles of radiation are first studied, whether it is in the basic form shown in the slide immediately following the outline or in the slide that shows the strength of radiation electric fields, the main issue of radiation, and especially radiation at resonance, is frequently difficult to both grasp and appreciate. The reason for that is, of course, that the expressions are in terms of current. If these were the currents determined from the circuitual parameters, that would imply that radiation is negligible and indeed the estimates of radiation would be computed as a correction. That, of course, would be relatively easy to do and, also, there would be few surprises in our designs. That is not how structures behave at resonance and, in particular, not the way strongly radiating structures can be characterized.

Slide #57

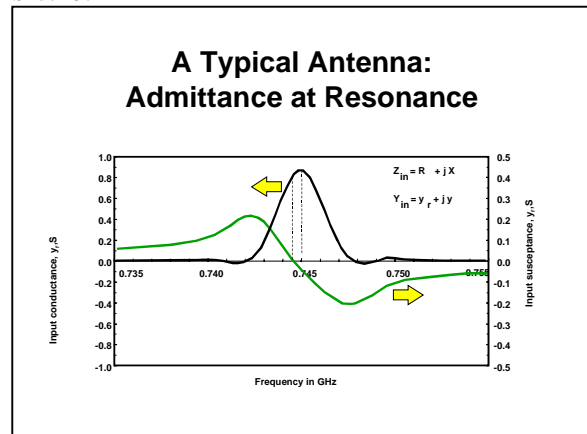

The most significant aspect of determining the behavior of a circuit under excitation is to establish the input impedance into the circuit so that not only the circuit parameters are taken into account but the radiation impedance is also included. Again, off-resonance and even at resonance under certain conditions, the radiation impedance is either very high or very reactive and the radiated power can indeed be computed using an iterative process.

At resonance, under some conditions, the radiation impedance can be comparable to circuit parameters or, if the circuit is designed for radiation, the radiation impedance may be matched to the source. In any event, the radiation impedance becomes a significant board in comparison to the circuitual parameters and, therefore, the circuit is solved correctly only when the variation of the radiation impedance with frequency is taken into account. An example of a very low impedance radiation structure is illustrated in the slide. Examples of the radiation resistance of such classical structures as a whip monopole and a whip dipole can also serve as useful points of reference. These resistances (at resonance) are approximately 140Ω and approximately 70Ω , respectively.

Slide #58

Outline

- Review of current high speed issues
- Penalties for poor design: example
- Achieving ultrahigh speed by design
- Resonance effects in electromagnetics
- The power of resonance: transmission
- Elements and principles of radiation
- *The power of resonance: emissions*
- Resources, technologies, conclusions

As shown on the slide, the interaction resonance is a very narrow band and the radiation is enhanced by more than two orders of magnitude at maximum. This case alone merits careful investigation because the implications on emissions are enormous. Other situations worth examining relate to the generation of extraneous energy in parallel plane and slotline modes, which are examined later.

Slide #59

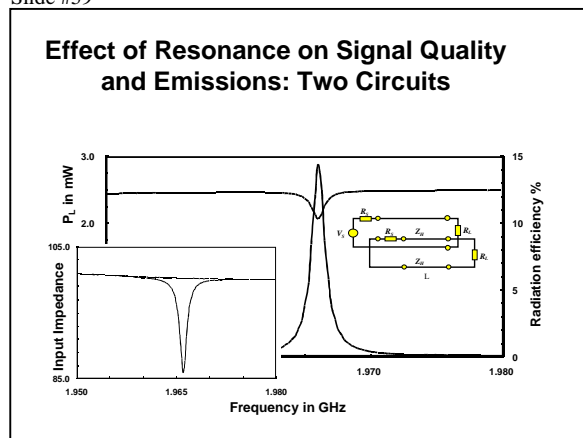

As a general rule, if two circuits are at resonance at the same frequency and each has a certain radiation impedance at resonance, then the combined radiation impedance is lower than either of the individual impedances when the two circuits are allowed to couple their energy, such as two circuits in sufficient proximity to experience cross talk. Since the first circuit that was examined earlier has been analyzed in detail, the same example is developed for our estimation of cross talk and emissions. Recalling that cross talk is a very strong function of terminations, this experiment consists of the original circuit properly terminated and the second terminated in high impedance. The separation between the circuits corresponds to standard board layout separation. Since the high impedance enhances the coupling and both high impedance sections are at resonance, the effect is very dramatic.

Slide #60

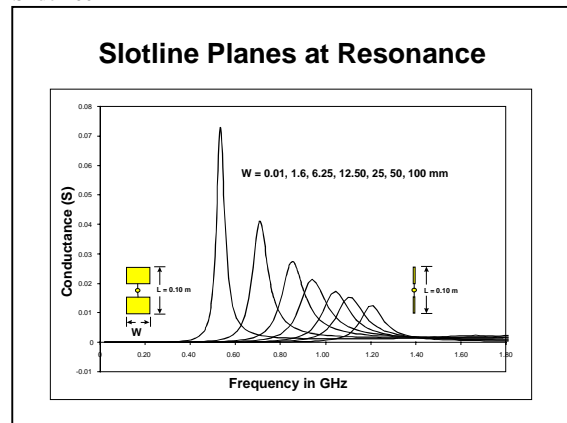

The above illustration summarizes the results of several studies aimed at determining the radiation modes and frequencies of ground planes that could be under excitation through slotline mode conversion. One of the important observations is the rapid decrease of the resonant frequency even though the dipole dimension L is not changed.

Slide #61

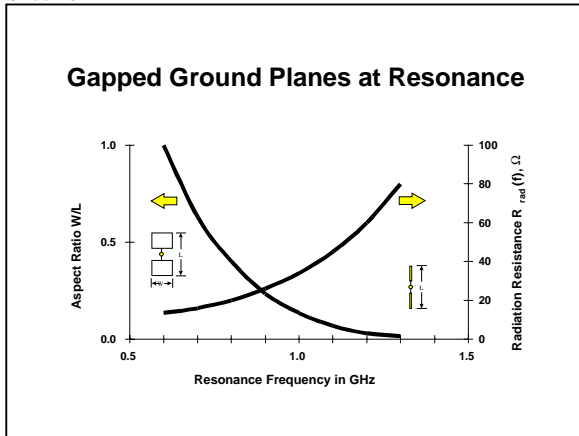

When energy into a slotline mode is supplied from signal carrying microstrips, it should be possible to approximate the source impedance by two microstrips in parallel which, in a 50Ω environment, should be 25Ω . It is significant to see that conditions exist such that the input impedance into the radiation mode quickly decreases into that range as the surfaces widen.

Slide #63

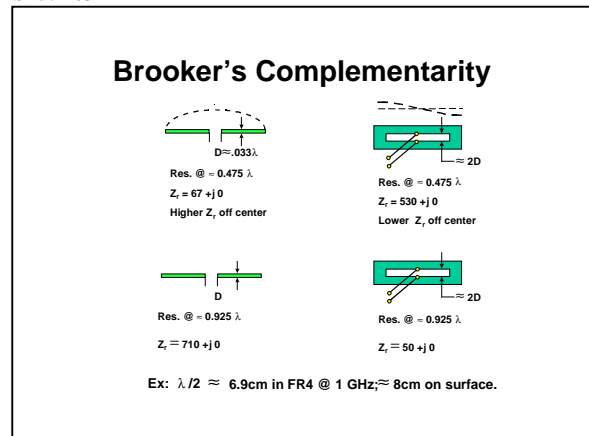

It should be noted that closed slots (or shorted slots by, far example, decoupling capacitors) could also be effective emitters under the right circumstances.

Slide #62

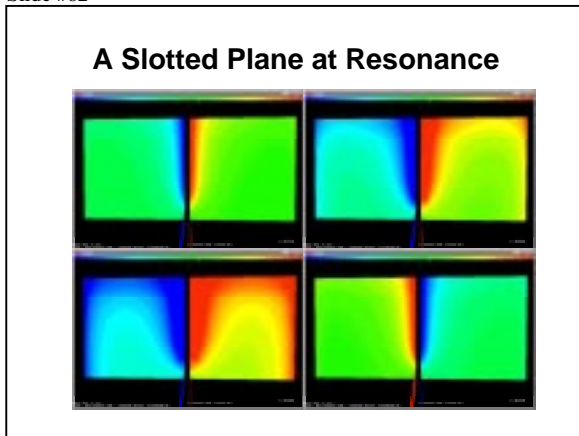

This sequence of animated frames demonstrates one of the modes of resonance for a pair of planes excited by a slotline mode.

Slide #64

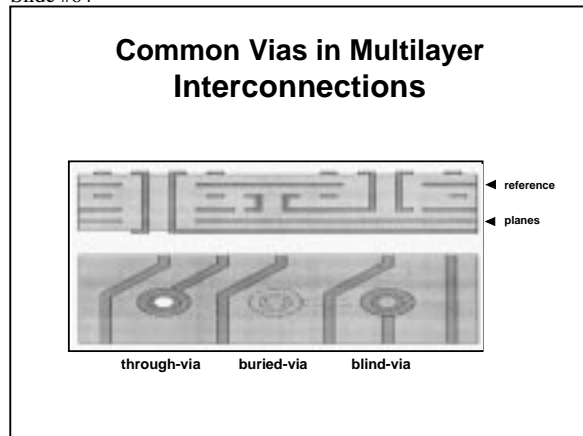

Our board layouts consist of many vertical structures that can generate incremental signals between reference and power planes. Since the fundamental mode of the parallel plane waveguide has no cutoff, these signals can develop regardless of the separation between planes. When the dimensions of the board correspond to resonance, this energy is released into space.

Slide #66

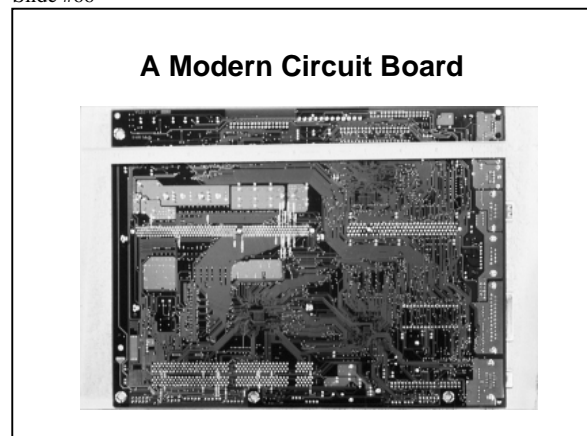

Even under the conditions where it is clear that many rules for signal quality have been obeyed, the probability for resonance is high and is experiencing unprecedented growth as clock rates are increasing. A number of potential resonance's are easily identifiable on some of the best designed boards. Therefore, the probability for finding others, perhaps more subtle, is also very high. Resonance's involving ground and power planes are even more subtle because many effective dimensions are not the actual geometric dimensions.

Slide #65

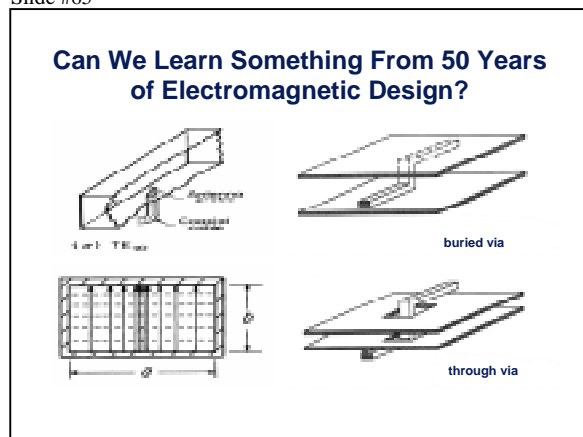

Slide #67

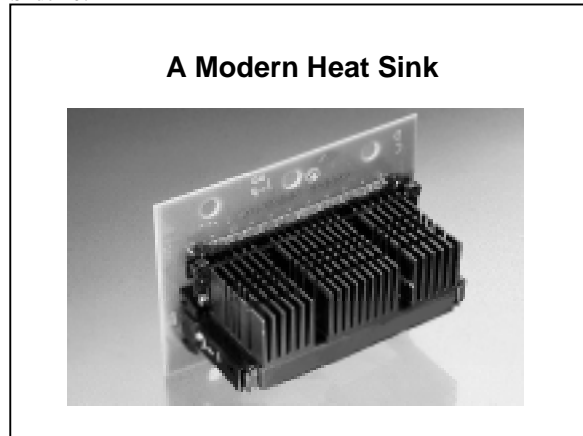

Consider the issue of just the heat sink. As dissipation power is growing, the size of the heat sink is mushrooming. What's more, the desire to reduce fan noise further motivates the implementation of large heat sinks. In the example considered, in a heat sink of overall dimensions 13.5 x 5 cm base and 5 cm intricate fins, a number of resonant frequencies are identifiable ranging from 30 MHz to 1.15 GHz. Because there are so many dimensional freedoms, the resonance's are likely to be broad, perhaps overlapping. Modeling or testing would need to be done for both estimating the coupling coefficients and radiation efficiencies.

Slide #68

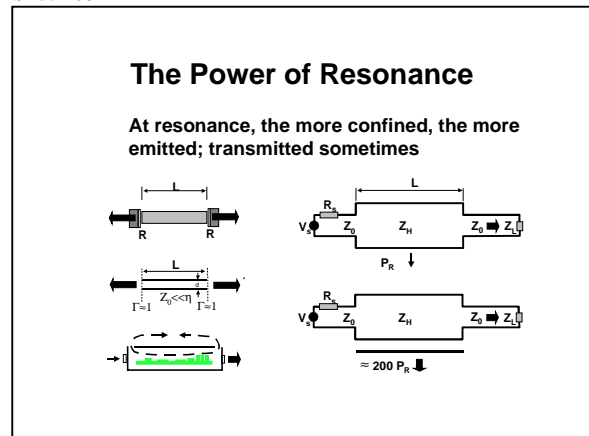

Under certain conditions, emissions can increase when an enclosure is more complete. It is only surprising when resonance is either not understood or the mode is not identified.

Slide #69

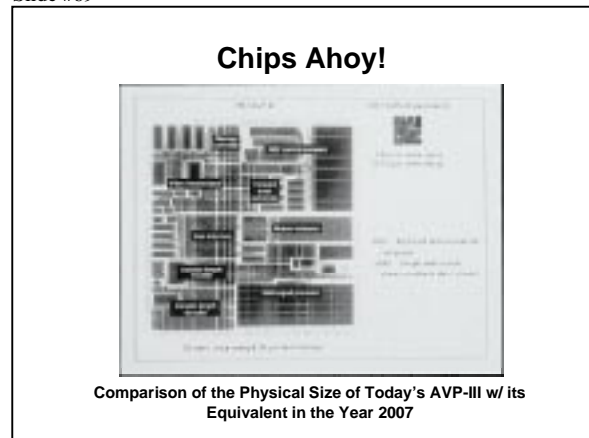

Slide #70

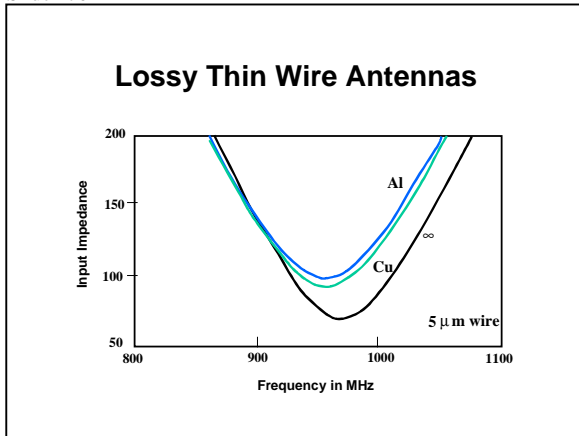

The following study considers the effects of thin lossy conductors. When an antenna is made of a very thin (5 μm) wire, the input impedance of such a lossy wire antenna at resonance is very high, regardless whether aluminum or copper is used.

Slide #72

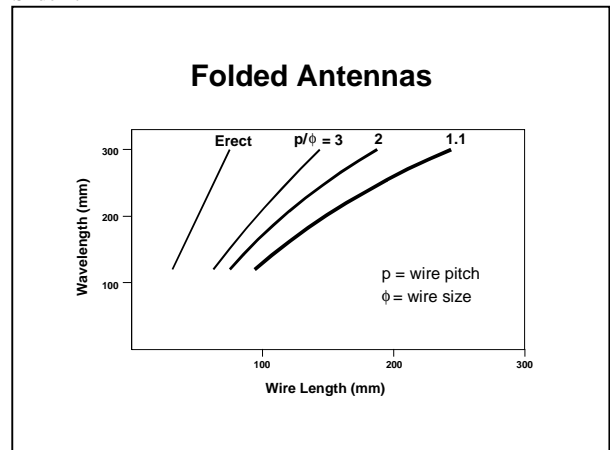

It is also known that regardless whether a wire is straight or folded, it has no influence as to whether it can be an effective emitter or not at some defined frequency. Antennas are designed as straight whips as well as folded or wound geometries. In general, it takes more physical wire length when an antenna is folded than when an antenna is completely erect. In order to appreciate the effect of “folding” or winding long wires, the effect of helical winding is illustrated for different helix pitches. Nevertheless, even when the most conservative estimates are made there can be anywhere between one thousand and ten thousand resonant antenna lengths on a large processor at 1 GHz if all nets were to be simultaneously connected. And, of course, multiples of that for the harmonics. Since emission from a net at resonance is two to three orders of magnitude larger than emission from a nonresonant circuit, it takes only a few resonant circuits to exceed emissions estimated by conventional methods.

Slide #71

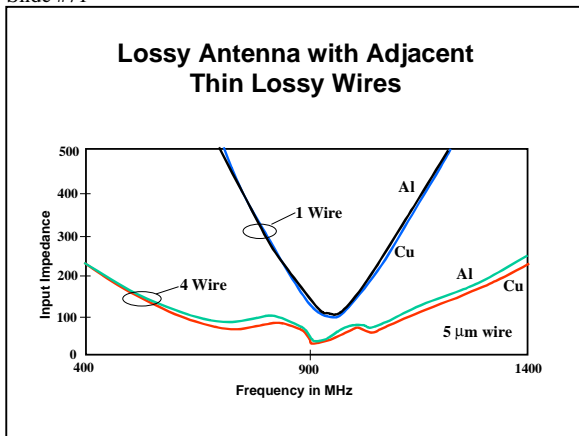

When additional lengths of the same wire are brought in the vicinity, the input impedance is reduced substantially, just like in the case of the two circuits at resonance. When the additional wire is of the same length, it simply lowers the input impedance. When the lengths are somewhat different, the input impedance decreases and the resonance broadens over the space of all the wire resonances.

At this time, no firm conclusion can be made as to whether or not resonance effects taking place directly on the IC are responsible for increased emissions from new processors and other large integrated circuits. The emissions from integrated circuits might also depend on how well the near fields couple into contiguous structures that have much larger surfaces and lower resistances to emit effectively.

Slide #73

Outline

- Review of current high speed issues
- Penalties for poor design: example
- Achieving ultrahigh speed by design
- Resonance effects in electromagnetics
- The power of resonance: transmission
- Elements and principles of radiation
- The power of resonance: emissions
 - Resources, technologies, conclusions

Slide #75

Revisiting Noise Cancellation

- *For signal quality at high speed:* noise minimization described and documented in earlier papers: budget of Z, noise cancellation, dc high speed net, no parasitics; applied in designs throughout the industry.
- *For reducing emissions:* cancellable by design while still within the bounding electrodes as voltages and currents; fields, algebraic in space but not cancellable practically; redirectable, capturable, but not well.

Slide #74

Comparison of Resonant Structures

The diagram compares resonant structures in three columns: Wires, Planes, and Planes.

Row 1: Dipole, f. Wires: length $\lambda/2$. Planes: length $\lambda/4$, height h . Planes: width w , height h , $w \ll \lambda/4$.

Row 2: Dipole, 2f. Wires: length $\lambda/2$. Planes: width w , length $\ll \lambda/2$. Planes: length $\lambda/2$, height h .

Row 3: Monopole. Wires: length $\lambda/4$. Planes: length $\lambda/4$. Planes: length s .

Labels at the bottom: **Wires**, **Planes**, **Planes**.

Slide #76

Emission Noise Cancellation (A)

Reduce emission noise, susceptibility **BY DESIGN**

- Avoid // plane waveguide mode signal accumulation between ground/power planes
 -
 -
 -
- Avoid // plane waveguide mode signal accumulation between boards
 -
 -

In closing this discussion, a number of issues appear to be in need of attention.

One way to be alert and prepared to recognize situations that could be troublesome, is to have a facility to recognize the fundamental modes of resonance oscillation in more and more complex structures.

The methods for reducing parallel plane waveguide modes already discussed should be used to minimize the accumulation of energy in that mode both within boards and between boards.

Slide #77

Emission Noise Cancellation (B)

Reduce emission noise, susceptibility *BY DESIGN*

- Avoid slotline mode signal accumulation at islands and split ground/power planes

dm

statistics in routing

resonance issue

- Avoid slotline mode signal accumulation at board junctions

quality connectors

controlled Z_0 , symmetry

The methods for reducing slotline modes already discussed should be used to minimize the accumulation of energy in that mode both within boards and between boards.

Note in particular that neither the parallel plane waveguide mode nor the slotline mode has a cutoff frequency. Moreover, note that these modes between boards are launched by shortcomings in corresponding interconnections.

Slide #78

Emission Noise Minimization

- Maximum power transfer theorem

- Off resonance $|Z_r| = |R_r + jX_r| \gg R_L; X_r \gg R_r$
- At resonance $|Z_r| = R_r(f_0) = R_L; X_r = 0$
- Resonance is a multi-order magnitude effect

As discussed before, in addition to minimizing cancelable noise, efforts need to be directed toward avoiding the creation of unnecessary reflective boundaries. Impedance discontinuities act as reflecting mirrors and determine the spaces within which resonance can be established. At resonance, radiation impedance can compete with load impedances.



Slide #79

Resources

- Test instrumentation very advanced, very versatile
 - Diff. TDR: HP 54754A w/83480A mainframe
 - Pulse gen., 3 GHz ($\tau_r = 60$ ps) HP 8133
 - Field probe (close field), 1 GHz, HP 11940A
 - Spectrum analyzer, 6.5 GHz, HP 8595EM
 - Computational, HP C 180 VIS-EG, 384M
- Choice interconnection technologies, very advanced
 - High density, high speed technologies avail.
- Seminar/workshop (2d): signal quality/emissions
- Design aids, combine sig. qual./emissions, lagging

Enormous resources for developing high-speed, Low-emission/susceptibility systems are available within our industry but are not without shortcomings. With additional alertness to the principles of radiation and particularly to radiation at resonance. Principles of noise cancellation and noise/emission minimization can substantially improve the design of systems for high speed. Since resonance is a multi-order of magnitude phenomenon, avoiding one network or one structure at resonance can make or break the qualification of a design.

Slide #80

Three Laws

- Improve signal quality **BY DESIGN**
- Reduce system noise **BY DESIGN**
- Reduce rad./suscept. **BY DESIGN**

To a large degree, control of radiation and susceptibility to radiation is going to be as much of an attention to detail issue as a fundamental radiation law issue. It is clear that many critical situations can be improved by design just like high speed is achieved by design.